



# Process Modeling

Today & Tomorrow

**Kathy A. Long**  
**Process Renewal Consulting Group Inc.**  
**(303) 697-4607** [klong@processrenewal.com](mailto:klong@processrenewal.com)  
[www.processrenewal.com](http://www.processrenewal.com)



# Copyright



**This presentation contains proprietary methods and materials developed by The Process Renewal Consulting Group Inc..**

**They may not be copied, recorded, transmitted or reused without the expressed permission of the author. All rights reserved.**



# Devils Advocate ?



# Modeling Requirements

**IGOE\* = Input, Guide, Output, Enabler**

- **Input** : something that is utilized consumed by or transformed by an activity (process); *Connects to left side of 'box'*
- **Guide** : something that determines how or when an activity occurs but is not consumed; *Connects to top of 'box'*
- **Output** : something that is produced by or results from an activity/process; *Flows from right side of 'box'*
- **Enabler** : something (person, facility, system, tools, equipment, asset or other resource) utilized to perform the activity; *Connects to bottom of 'box'* *Note: Enablers are NOT consumed.*

*An **IGOE** might be a physical object, rule, goal, principle or piece of data, a machine, a computer system or anything that is relevant to the process*

*\*Note: These concepts are based on upon the principles and rules of IDEF0, which refers to IGOEs as Inputs, Controls, Outputs, and Mechanisms - ICOMs); ICOM=IGOE*

# Why Modeling Standards ???

## Off-Site Dining Process

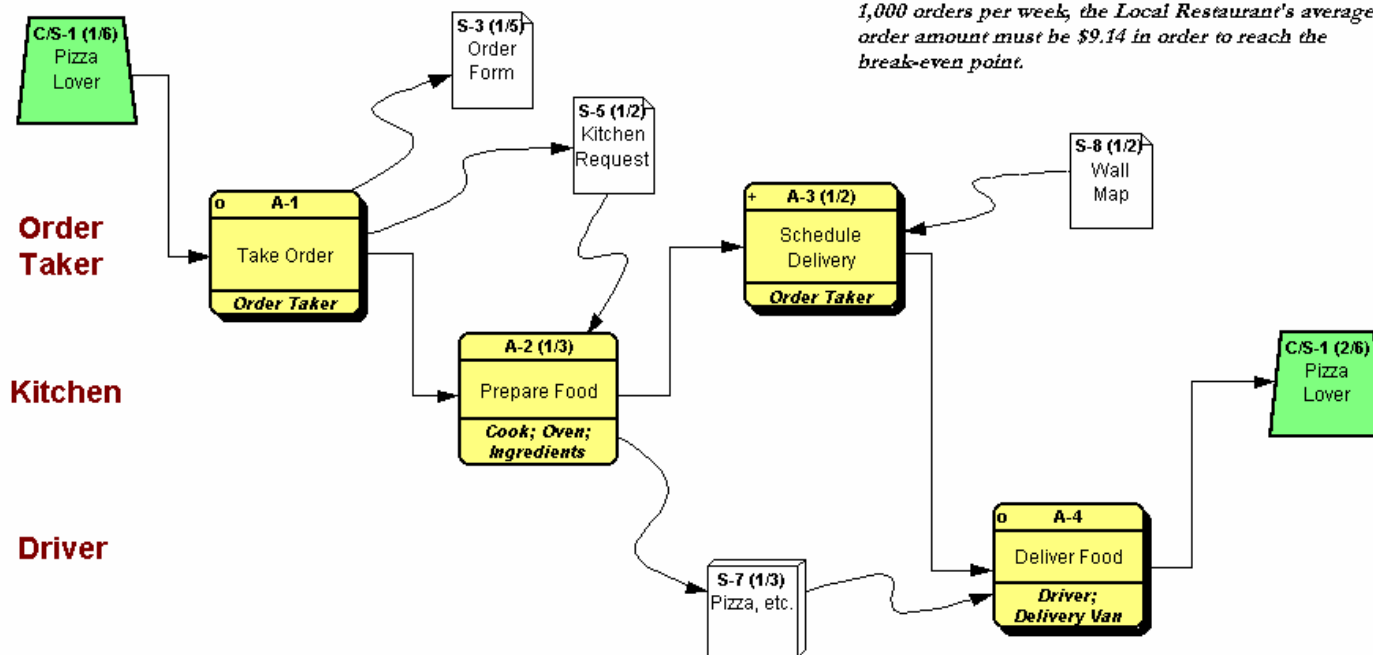

**NOTE:**  
At an annual expense of \$475,161 and volumes of 1,000 orders per week, the Local Restaurant's average order amount must be \$9.14 in order to reach the break-even point.

<b>Project:</b> Off-Site Dining Analysis	
<b>Organization:</b> Local Restaurant	
<b>Manager:</b> INTEC Systems - jps	<b>02/17/99 01:15 PM</b>

**Cost Breakdown by Type:**  
 Labor: \$90,133  
 Equipment: \$62,400  
 Computer: \$0  
 Storage: \$0  
 Communication: \$0  
 Transportation: \$12,740  
 Material: \$156,000  
 Other: \$0

<b>Key Statistics:</b>
<b>Total Annual Cost:</b> \$386,810
<b>Total Annual FTE's:</b> 4.0917
<b>Annual Cost of Delivering Food:</b> \$0
<b>Annual Cost of Credit Card Processing:</b> \$0
<b>Annual Taxi Costs:</b> \$12,740
<b>Best Case Cycle Time:</b> 23.6 minutes

<b>Drivers Required by Day*:</b>
Mon - Thurs: 0.81
Fri - Sat: 4.88
Sunday: 3.25
<small>* To maintain cycle times and overall FTE level near 3.</small>

# Why Modeling Standards ???

USED AT:	AUTHOR:K Long PROJECT:Local Restaurant	DATE: 02/17/1999 REV: 1	x	WORKING	READER	DATE	CONTEXT:
				DRAFT			
				RECOMMENDED			
				PUBLICATION			
NOTES: 1 2 3 4 5 6 7 8 9 10							A-0

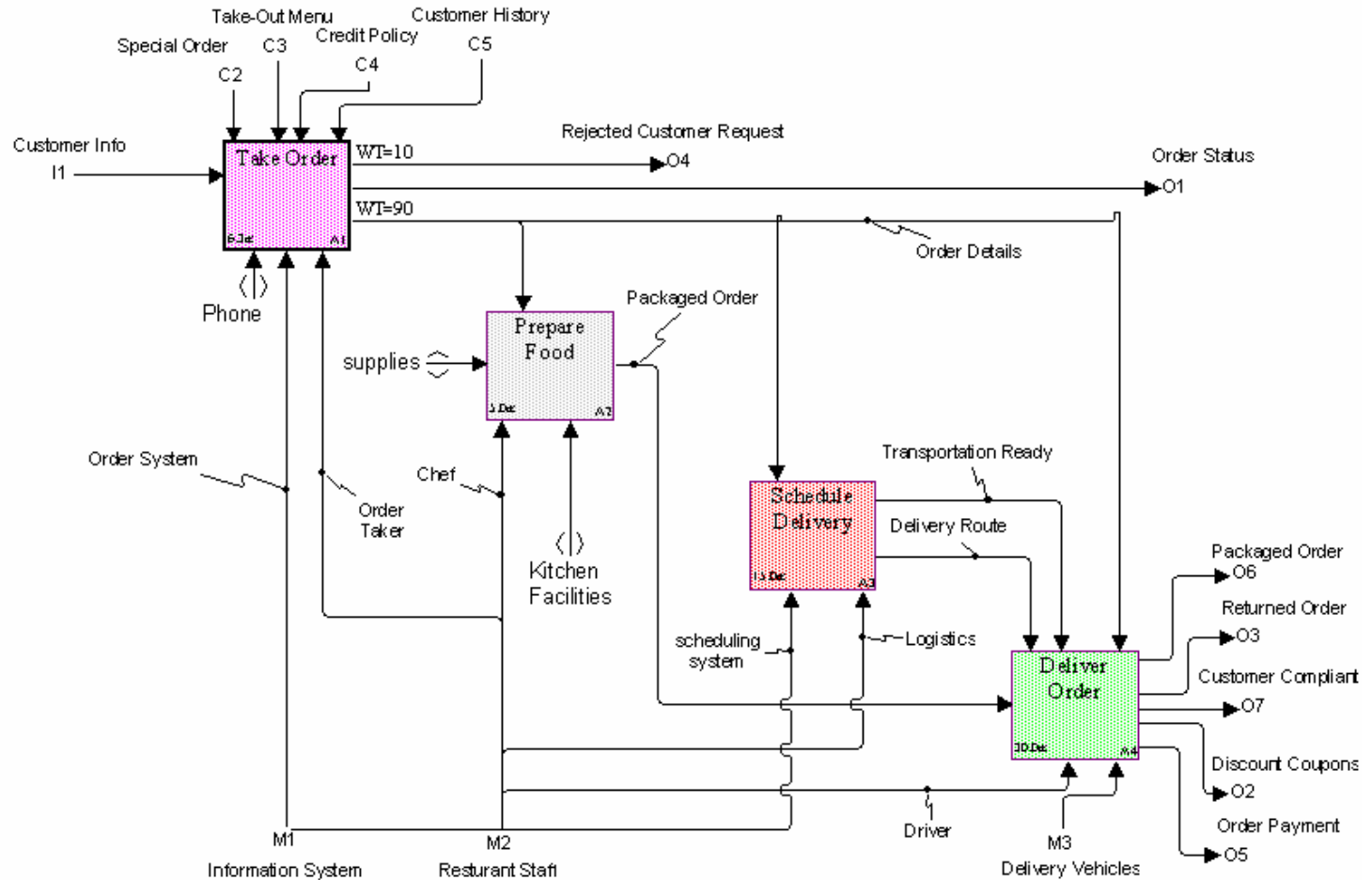

NODE: A0

TITLE: Provide Take-Out and Delivery Service

NUMBER: k13

P.2

# Why Modeling Standards ???

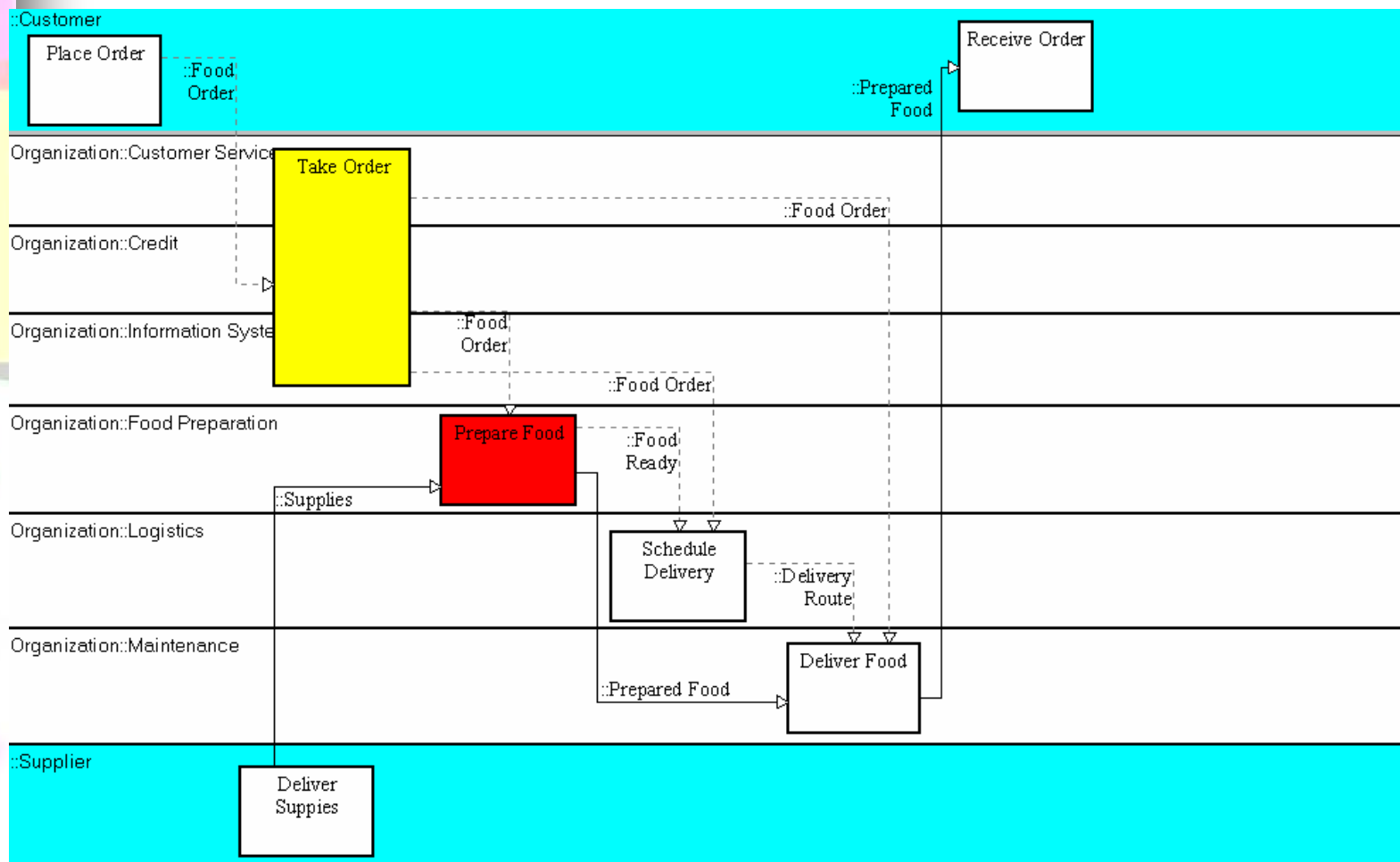

# Why Modeling Standards ???

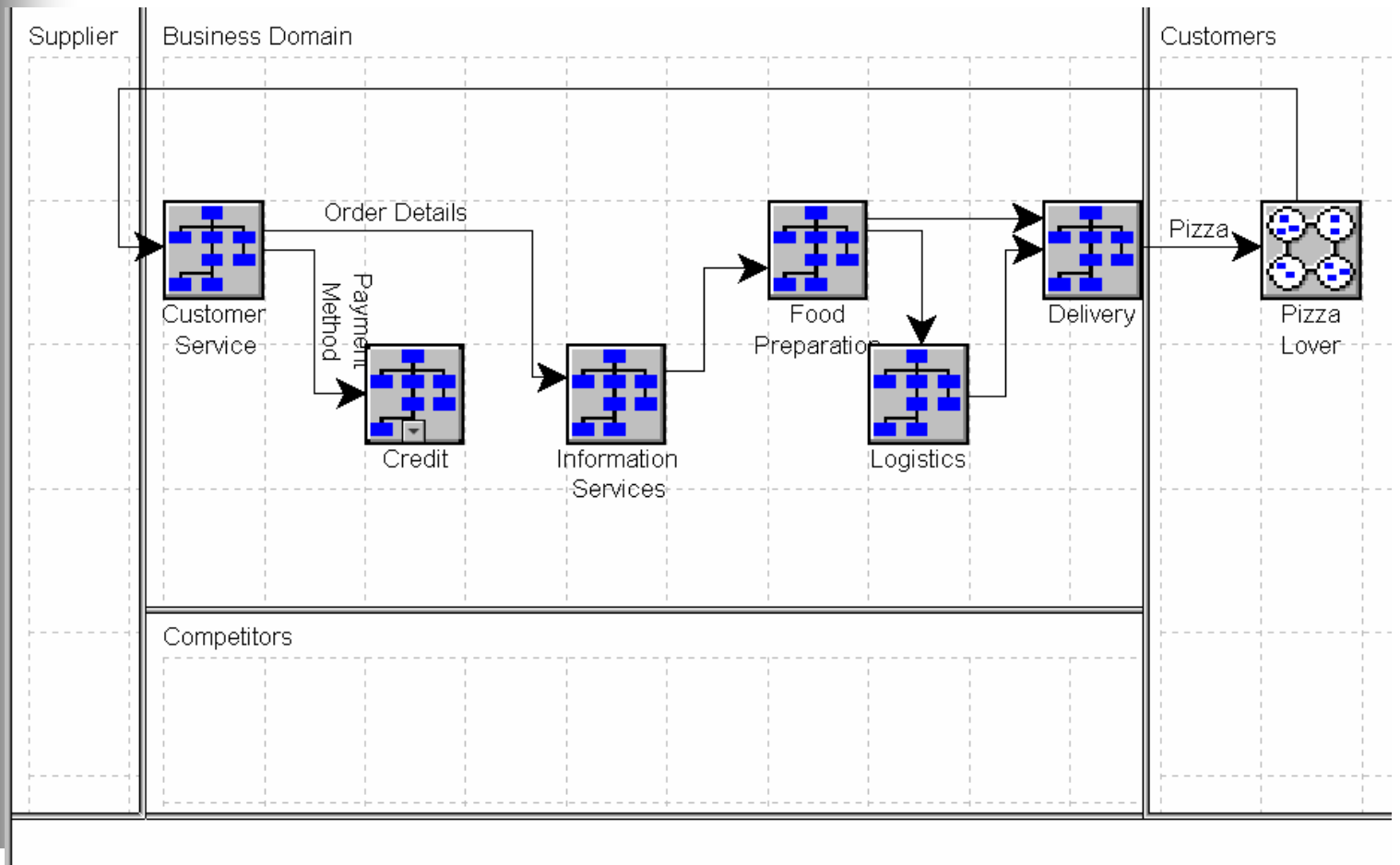

# Why Modeling Standards ???

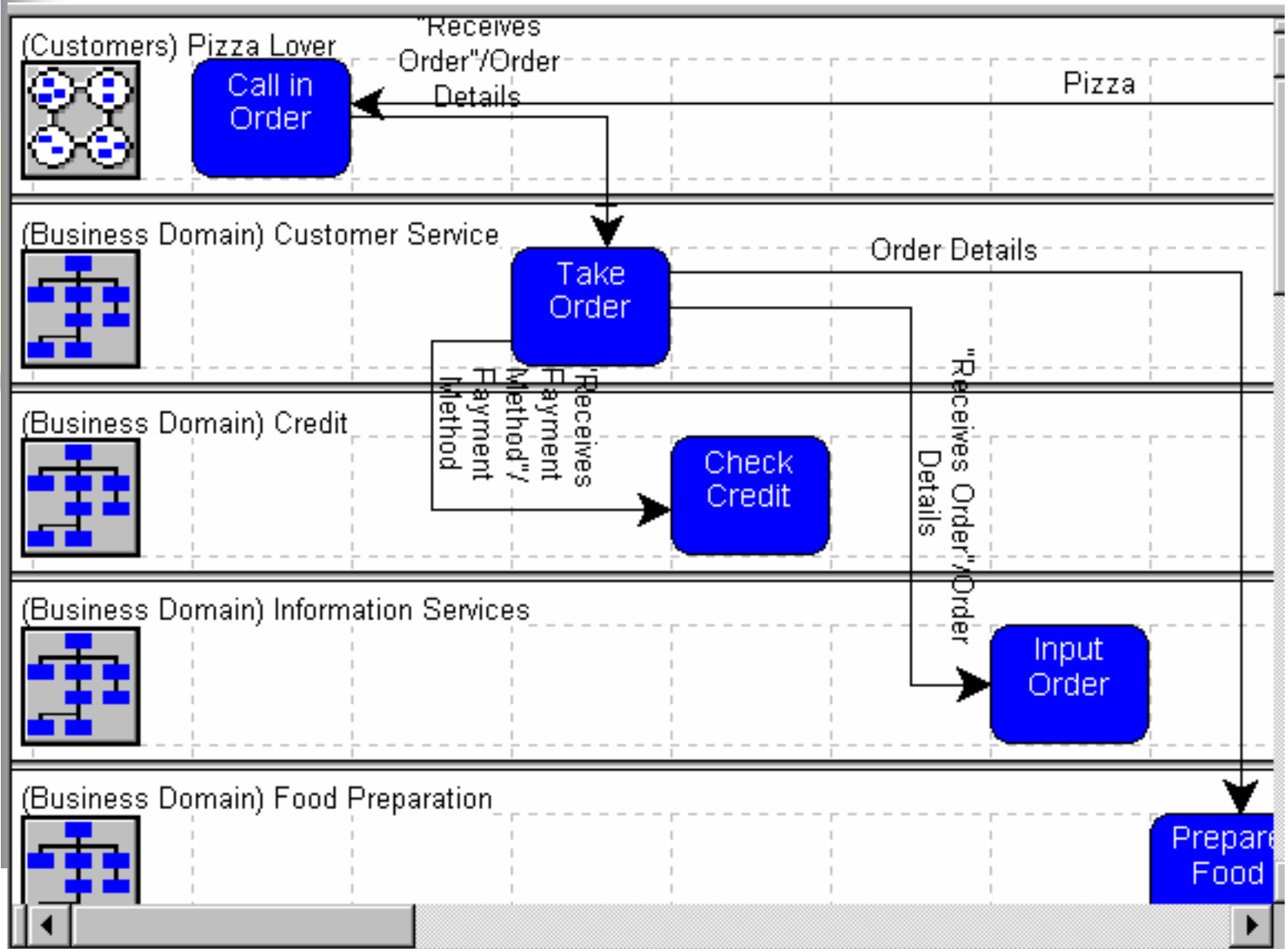

# Why Modeling Standards ???

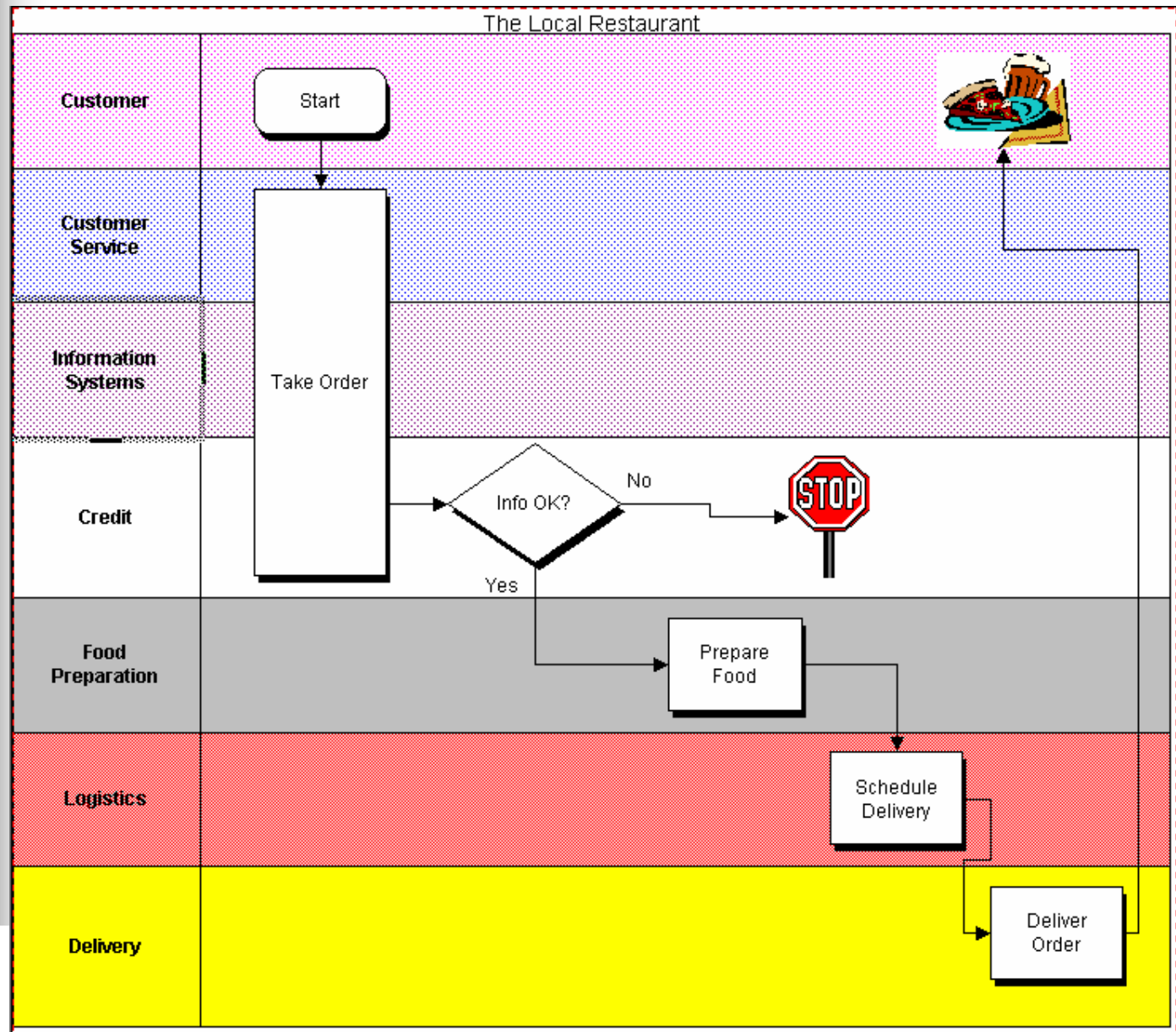

# Why Modeling Standards ???

*The Local Resturant*

*Process Flow*

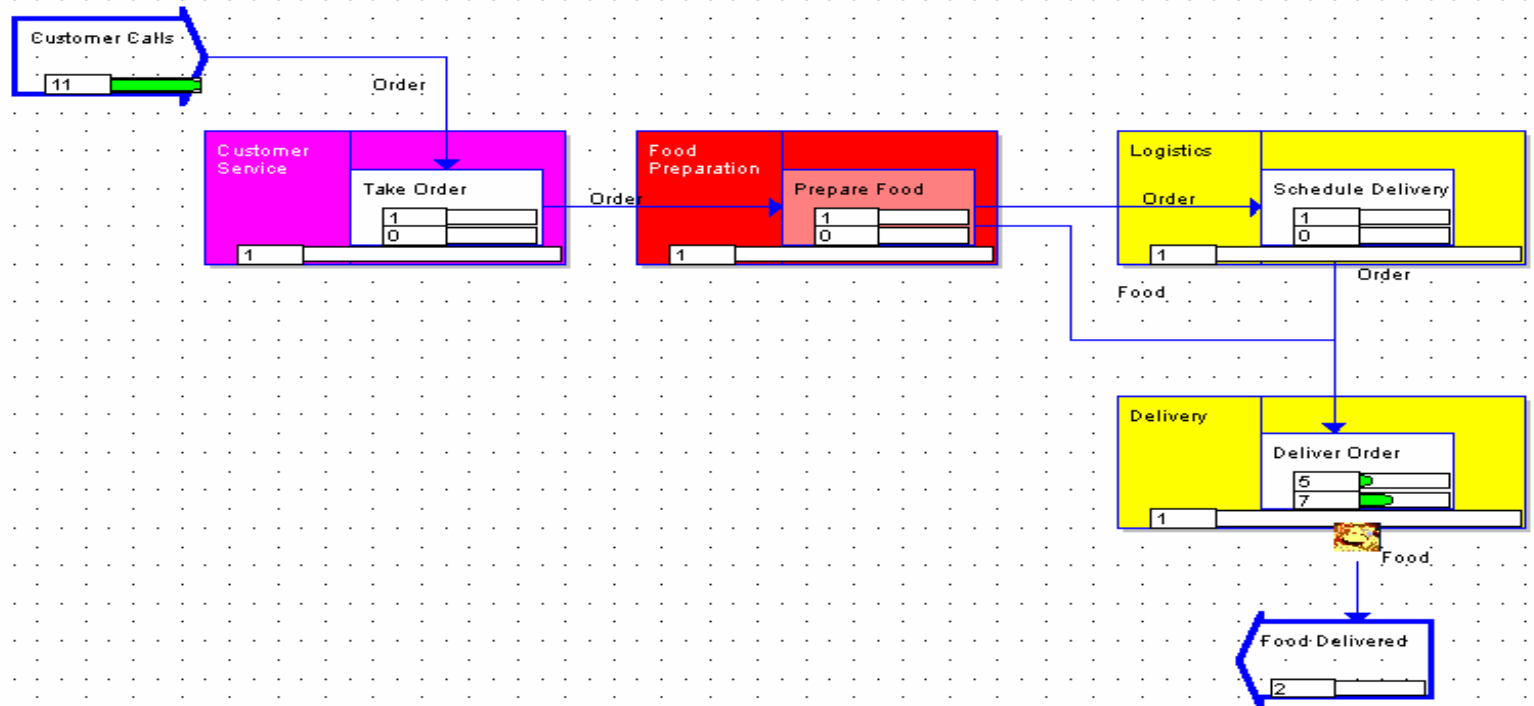

# Why Modeling Standards ???

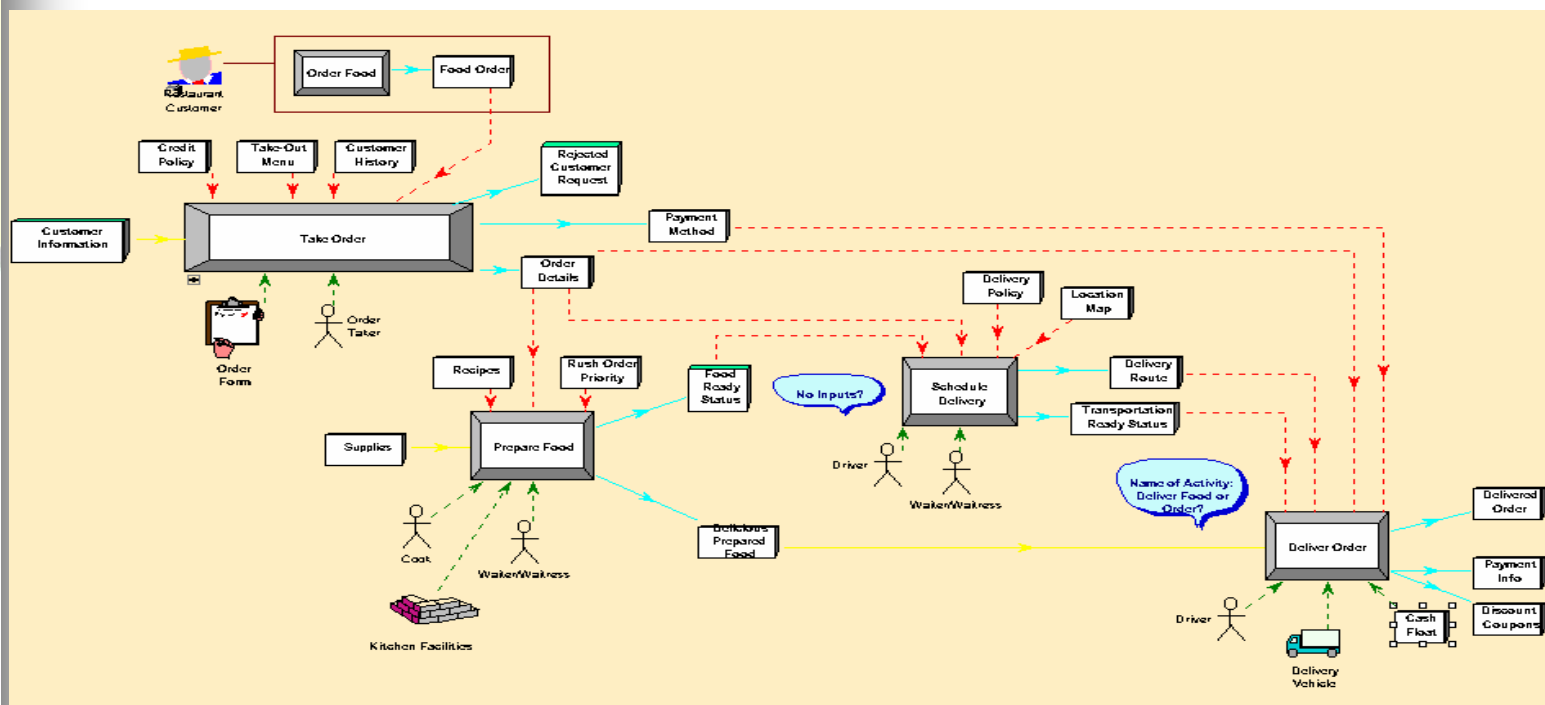

# Where's the GREATEST Opportunity

## Improvement Potential

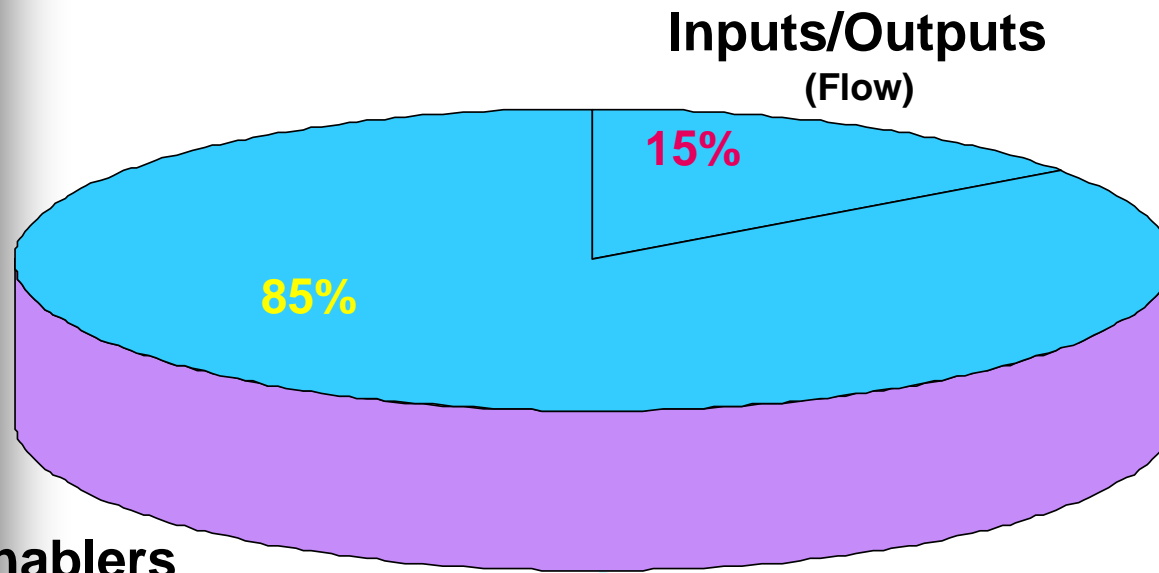

### Guides/Enablers

(Policies, Procedures,  
Bureaucracy, Knowledge,  
Experience)

**Most organization fail to realize their most profitable opportunities because they refuse to change policies & procedures**

# Future of process modeling

BPMI.org

## Core set of diagram elements

Events



Activities

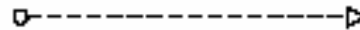

Gateways



You be the Judge

# Future of process modeling

BPMI.org

Compete set of diagram elements, events



You be the Judge

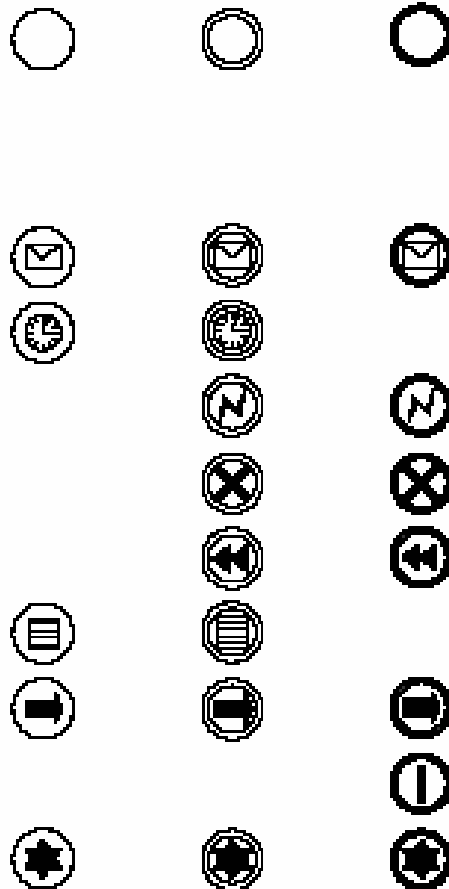

# Future of process modeling

BPMI.org

Compete set of diagram elements, activities



You be the Judge

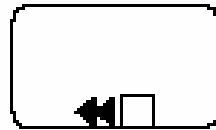
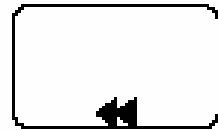
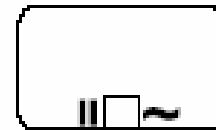
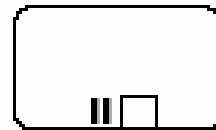
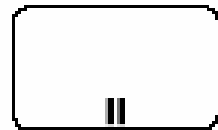
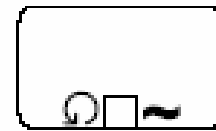
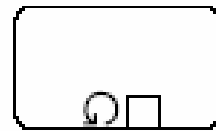
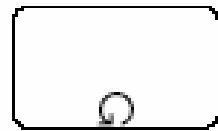
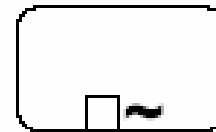
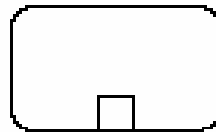

# Future of process modeling

BPMI.org

Complete set of diagram elements, connections

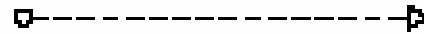

You be the Judge

# Future of process modeling

BPMI.org

Compete set of diagram elements, gateways

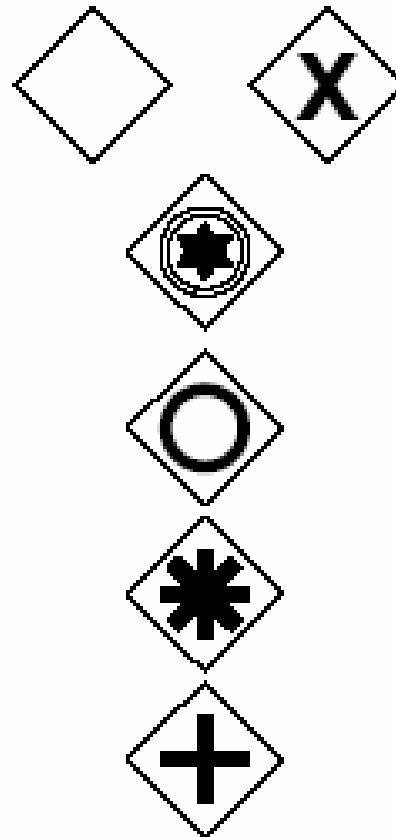

You be the Judge

# Business Process Modeling Notation

BPMI.org

The BPMN will provide businesses with the capability of defining and understanding their internal and external business procedures through a Business Process Diagram, which will give organizations the ability to communicate these procedures in a standard manner. BPMN will also be supported with an internal model that will enable the generation of executable BPEL4WS.



**You be the Judge**

# Excerpts from the BPMI.org Charter

BPMI.org

The BPMN Working Group will ensure that the notation will:

- Be acceptable and usable by the business community.
- Be constrained to support only the concepts of modeling that are applicable to business processes.
- Be useful in illuminating a complex executable process.
- The BPMN notation of a business process must be unambiguous. There should be a mapping from one or more BPMN notation instances to an execution level instance.



**You be the Judge**

# Excerpts from the BPMI.org Charter

BPMI.org

In the course of its work the BPMN Working Group will:

- Seek to minimize the technical constraints placed upon the business user when modeling business processes. This principle is paramount.
- Determine the Business Process modeling concepts that are applicable to the graphical notation.
- Consider issues and opportunities of information sharing and dissemination in areas of common and related interest with other working groups and standards bodies.



**You be the Judge**

# BPMN Notation

BPMI.org

*The planned underlying metamodel is currently implicit. It may coincide with a Business Process Definition metamodel being developed by the OMG*



**You be the Judge**

# Plethora of Proprietary Notations

BPMI.org

Many process modeling tools and services use a variety of homegrown notations to depict and communicate business processes.



**You be the Judge**

# Normal Flow

BPMI.org

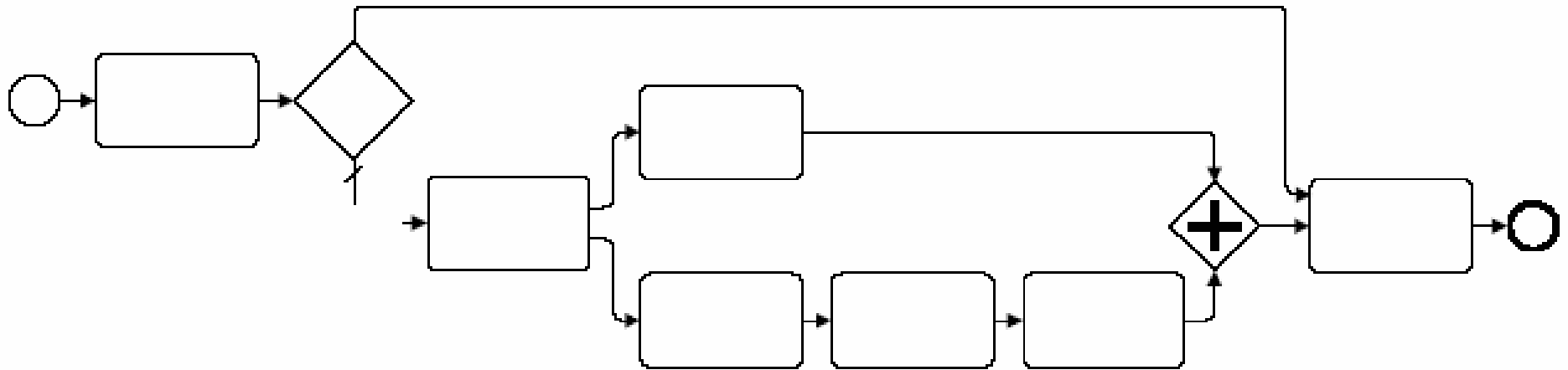

**You be the Judge**

# B2B Modeling

BPMI.org

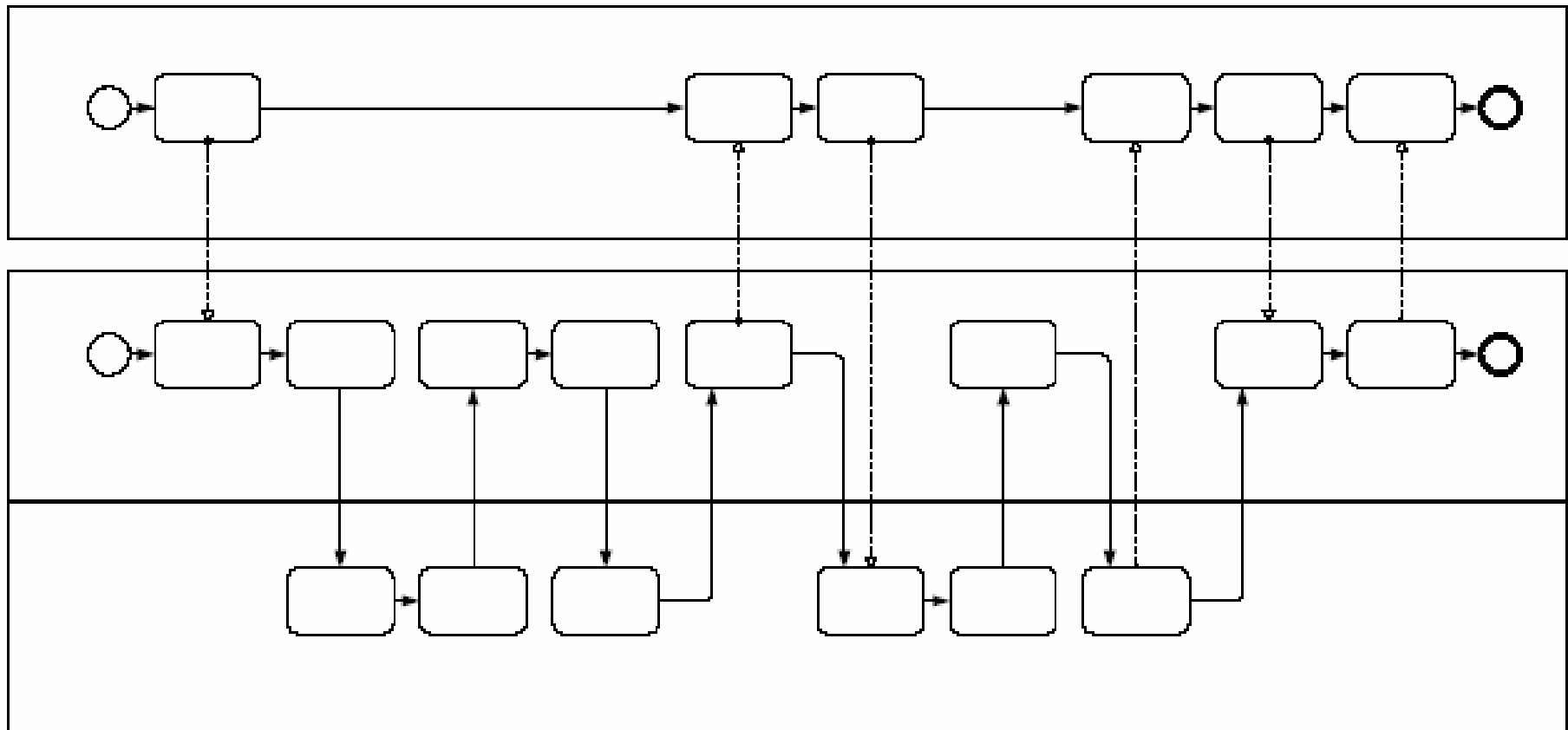

# Exception Handling

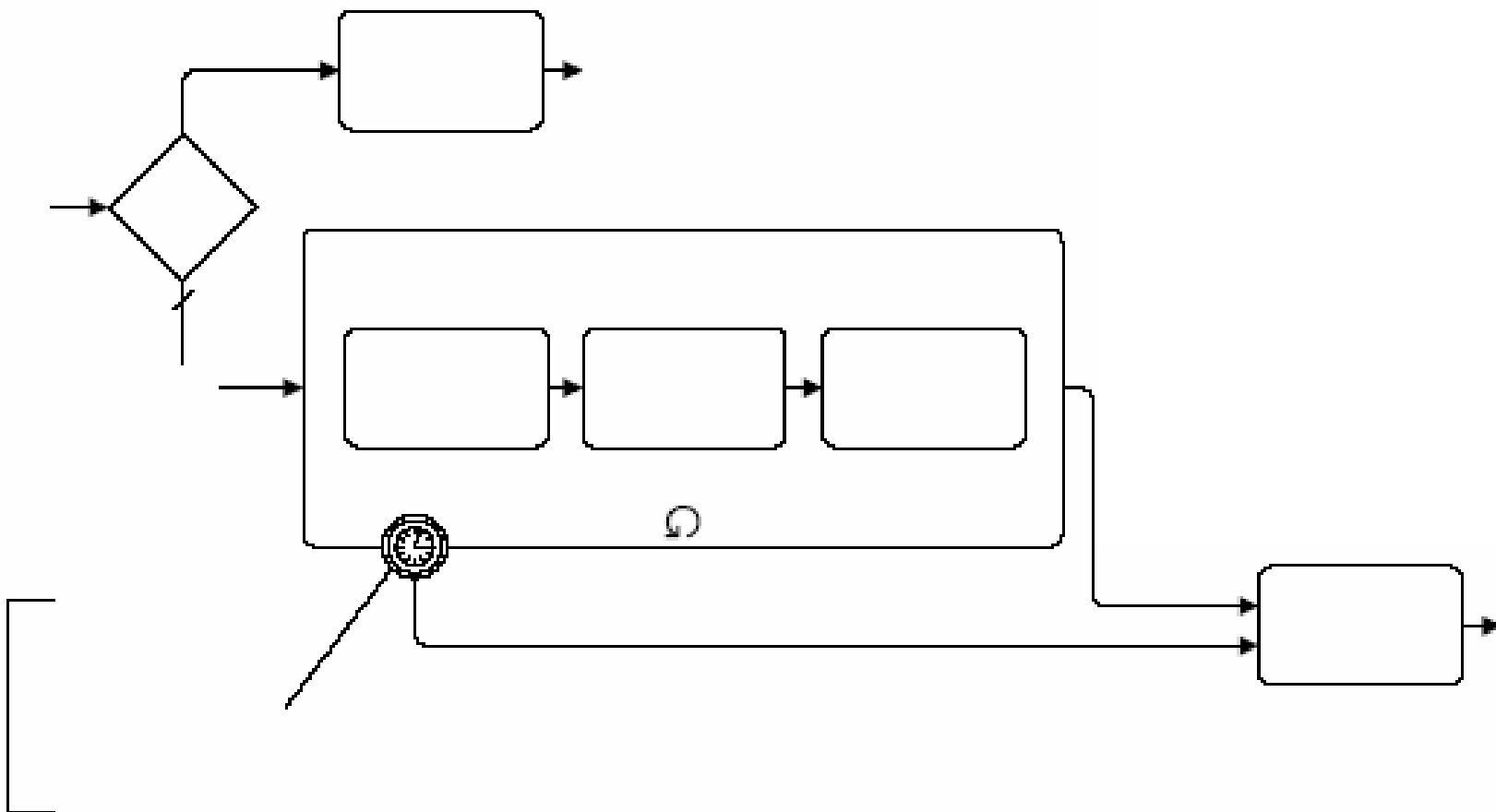

# Compensation Handling & Transactions

BPMI.org

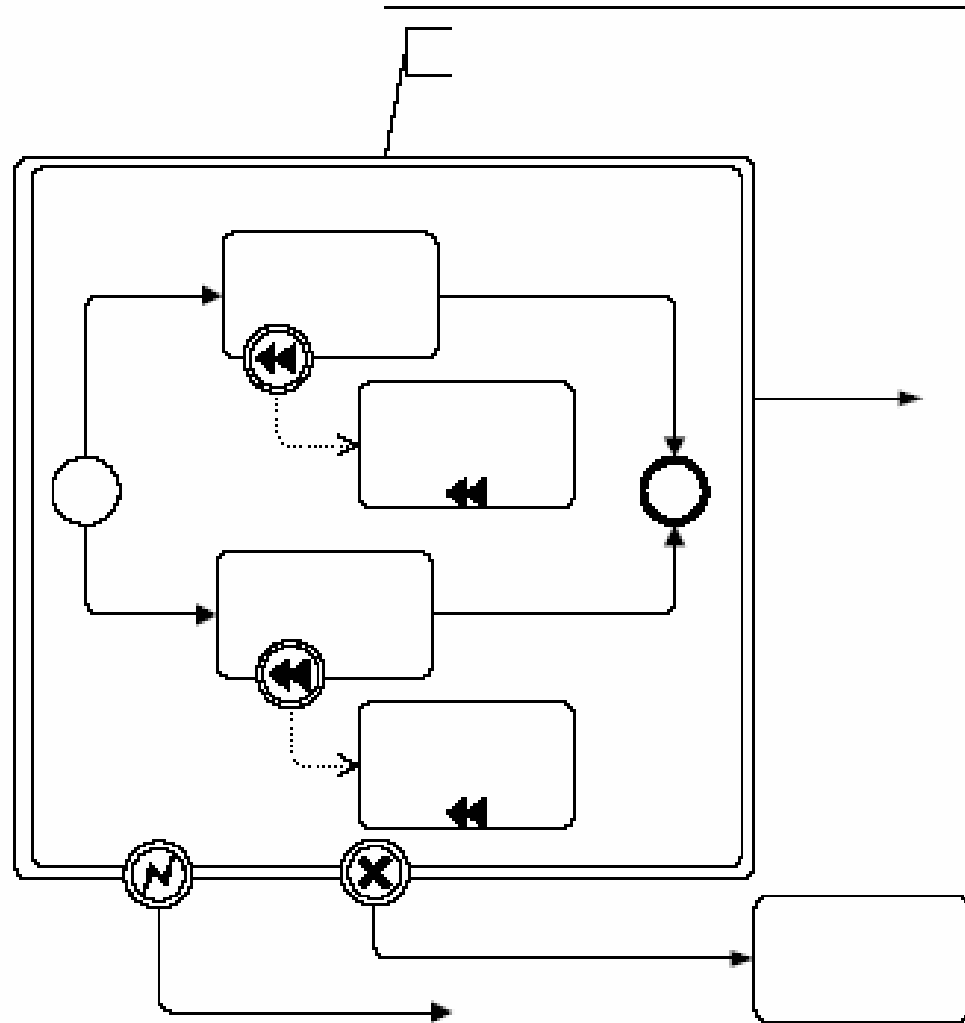

You be the Judge

# A Complex Process

BPMI.org

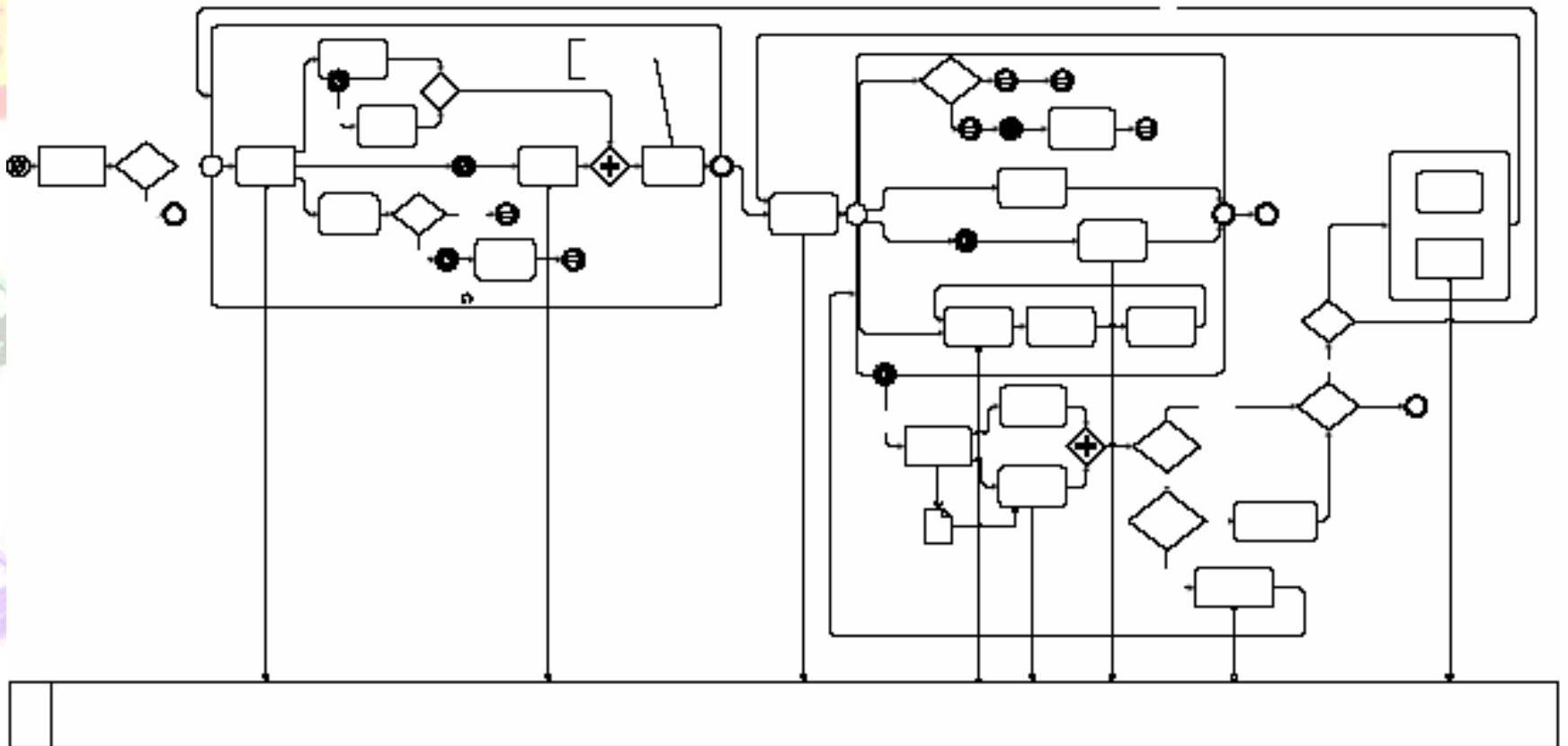

# Relationships with other Standards Organizations

BPMI.org

- **OMG**
  - The OMG has an RFP to develop a new UML business process definition (BDP) metamodel, which should be very close to the implicit metamodel for BPMN.
- **WfMC**
  - The WfMC has not developed a notation for XPD. They have adopted BPMN. WfMC members are working with the BPMI Notation Working Group to build a mapping from BPMN to XPD.
- **OASIS – WSBEL**
  - This TC is developing the next version of BPEL4WS. BPMN will be mapped to this version.
- **OASIS – ebXML**
  - The ebXML BPSS may have a mapping from BPMN.
- **W3C – Choreography**
  - It is planned to have a mapping from BPMN to the output of this
  - working group.



# What do you think?

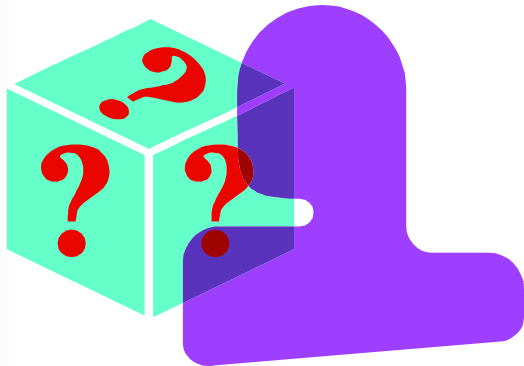

**You be the Judge**