



The Real-time Publish-Subscribe Wire Protocol DDS Interoperability Wire Protocol Specification

Version 2.~~0~~1

OMG Document Number: ~~formal~~ptc/2008-~~04~~06-~~09~~13
Standard document URL: [http://www.omg.org/spec/DDS/2.~~0~~1/PDF](http://www.omg.org/spec/DDS/2.0<u>1</u>/PDF)
Associated files*: [http://www.omg.org/spec/DDS/2007~~8~~06~~04~~15](http://www.omg.org/spec/DDS/20078<u>06</u>04<u>15</u>)

* original files: [ptc/~~07~~08-~~06~~0915](http://www.omg.org/spec/DDS/200708<u>06</u>-09<u>15</u>) (XMI)

Copyright © 1997-2008, Object Management Group.
Copyright © 2006, Real-Time Innovations, Inc.
Copyright © 2006, THALES

USE OF SPECIFICATION - TERMS, CONDITIONS & NOTICES

The material in this document details an Object Management Group specification in accordance with the terms, conditions and notices set forth below. This document does not represent a commitment to implement any portion of this specification in any company's products. The information contained in this document is subject to change without notice.

LICENSES

The companies listed above have granted to the Object Management Group, Inc. (OMG) a nonexclusive, royalty-free, paid up, worldwide license to copy and distribute this document and to modify this document and distribute copies of the modified version. Each of the copyright holders listed above has agreed that no person shall be deemed to have infringed the copyright in the included material of any such copyright holder by reason of having used the specification set forth herein or having conformed any computer software to the specification.

Subject to all of the terms and conditions below, the owners of the copyright in this specification hereby grant you a fully-paid up, non-exclusive, nontransferable, perpetual, worldwide license (without the right to sublicense), to use this specification to create and distribute software and special purpose specifications that are based upon this specification, and to use, copy, and distribute this specification as provided under the Copyright Act; provided that: (1) both the copyright notice identified above and this permission notice appear on any copies of this specification; (2) the use of the specifications is for informational purposes and will not be copied or posted on any network computer or broadcast in any media and will not be otherwise resold or transferred for commercial purposes; and (3) no modifications are made to this specification. This limited permission automatically terminates without notice if you breach any of these terms or conditions. Upon termination, you will destroy immediately any copies of the specifications in your possession or control.

PATENTS

The attention of adopters is directed to the possibility that compliance with or adoption of OMG specifications may require use of an invention covered by patent rights. OMG shall not be responsible for identifying patents for which a license may be required by any OMG specification, or for conducting legal inquiries into the legal validity or scope of those patents that are brought to its attention. OMG specifications are prospective and advisory only. Prospective users are responsible for protecting themselves against liability for infringement of patents.

GENERAL USE RESTRICTIONS

Any unauthorized use of this specification may violate copyright laws, trademark laws, and communications regulations and statutes. This document contains information which is protected by copyright. All Rights Reserved. No part of this work covered by copyright herein may be reproduced or used in any form or by any means--graphic, electronic, or mechanical, including photocopying, recording, taping, or information storage and retrieval systems--without permission of the copyright owner.

DISCLAIMER OF WARRANTY

WHILE THIS PUBLICATION IS BELIEVED TO BE ACCURATE, IT IS PROVIDED "AS IS" AND MAY CONTAIN ERRORS OR MISPRINTS. THE OBJECT MANAGEMENT GROUP AND THE COMPANIES LISTED ABOVE MAKE NO WARRANTY OF ANY KIND, EXPRESS OR IMPLIED, WITH REGARD TO THIS PUBLICATION, INCLUDING BUT NOT LIMITED TO ANY WARRANTY OF TITLE OR OWNERSHIP, IMPLIED WARRANTY OF MERCHANTABILITY OR

WARRANTY OF FITNESS FOR A PARTICULAR PURPOSE OR USE.

IN NO EVENT SHALL THE OBJECT MANAGEMENT GROUP OR ANY OF THE COMPANIES LISTED ABOVE BE LIABLE FOR ERRORS CONTAINED HEREIN OR FOR DIRECT, INDIRECT, INCIDENTAL, SPECIAL, CONSEQUENTIAL, RELIANCE OR COVER DAMAGES, INCLUDING LOSS OF PROFITS, REVENUE, DATA OR USE, INCURRED BY ANY USER OR ANY THIRD PARTY IN CONNECTION WITH THE FURNISHING, PERFORMANCE, OR USE OF THIS MATERIAL, EVEN IF ADVISED OF THE POSSIBILITY OF SUCH DAMAGES.

The entire risk as to the quality and performance of software developed using this specification is borne by you. This disclaimer of warranty constitutes an essential part of the license granted to you to use this specification.

RESTRICTED RIGHTS LEGEND

Use, duplication or disclosure by the U.S. Government is subject to the restrictions set forth in subparagraph (c) (1) (ii) of The Rights in Technical Data and Computer Software Clause at DFARS 252.227-7013 or in subparagraph (c)(1) and (2) of the Commercial Computer Software - Restricted Rights clauses at 48 C.F.R. 52.227-19 or as specified in 48 C.F.R. 227-7202-2 of the DoD F.A.R. Supplement and its successors, or as specified in 48 C.F.R. 12.212 of the Federal Acquisition Regulations and its successors, as applicable. The specification copyright owners are as indicated above and may be contacted through the Object Management Group, 140 Kendrick Street, Needham, MA 02494, U.S.A.

TRADEMARKS

MDA®, Model Driven Architecture®, UML®, UML Cube logo®, OMG Logo®, CORBA® and XMI® are registered trademarks of the Object Management Group, Inc., and Object Management Group™, OMG™, Unified Modeling Language™, Model Driven Architecture Logo™, Model Driven Architecture Diagram™, CORBA logos™, XMI Logo™, CWM™, CWM Logo™, IOP™, MOF™, OMG Interface Definition Language (OMG IDL)™, and OMG Systems Modeling Language (OMG SysML)™ are trademarks of the Object Management Group. All other products or company names mentioned are used for identification purposes only, and may be trademarks of their respective owners.

COMPLIANCE

The copyright holders listed above acknowledge that the Object Management Group (acting itself or through its designees) is and shall at all times be the sole entity that may authorize developers, suppliers and sellers of computer software to use certification marks, trademarks or other special designations to indicate compliance with these materials.

Software developed under the terms of this license may claim compliance or conformance with this specification if and only if the software compliance is of a nature fully matching the applicable compliance points as stated in the specification. Software developed only partially matching the applicable compliance points may claim only that the software was based on this specification, but may not claim compliance or conformance with this specification. In the event that testing suites are implemented or approved by Object Management Group, Inc., software developed using this specification may claim compliance or conformance with the specification only if the software satisfactorily completes the testing suites.

OMG's Issue Reporting Procedure

All OMG specifications are subject to continuous review and improvement. As part of this process we encourage readers to report any ambiguities, inconsistencies, or inaccuracies they may find by completing the Issue Reporting Form listed on the main web page <http://www.omg.org>, under Documents, Report a Bug/Issue (<http://www.omg.org/technology/agreement.htm>).

Contents

1	Scope	1
2	Conformance	1
3	Normative References	1
4	Terms and Definitions	1
5	Symbols	1
6	Additional Information	2
6.1	Changes to Adopted OMG Specifications.....	2
6.2	How to Read this Specification.....	2
6.3	Acknowledgements	2
6.4	Statement of Proof of Concept.....	2
7	Overview	5
7.1	Introduction.....	5
7.2	Requirements for a DDS Wire-protocol.....	5
7.3	The RTPS Wire-protocol	6
7.4	The RTPS Platform Independent Model (PIM).....	7
7.4.1	The Structure Module	7
7.4.2	The Messages Module	9
7.4.3	The Behavior Module	9
7.4.4	The Discovery Module.....	9
7.5	The RTPS Platform Specific Model (PSM).....	10
7.6	The RTPS Transport Model	10
8	Platform Independent Model (PIM)	11
8.1	Introduction.....	11
8.2	Structure Module	11
8.2.1	Overview.....	11
8.2.2	The RTPS HistoryCache	16
8.2.3	The RTPS CacheChange.....	19
8.2.4	The RTPS Entity.....	20
8.2.5	The RTPS Participant.....	21
8.2.6	The RTPS Endpoint.....	22
8.2.7	The RTPS Writer	23

8.2.8	The RTPS Reader	23
8.2.9	Relation to DDS Entities	23
8.3	Messages Module	29
8.3.1	Overview	29
8.3.2	Type Definitions.....	30
8.3.3	The Overall Structure of an RTPS Message	31
8.3.4	The RTPS Message Receiver	35
8.3.5	RTPS SubmessageElements	37
8.3.6	The RTPS Header	43
8.3.7	RTPS Submessages	44
8.4	Behavior Module	67
8.4.1	Overview	67
8.4.2	Behavior Required for Interoperability	71
8.4.3	Implementing the RTPS Protocol	73
8.4.4	The Behavior of a Writer with respect to each matched Reader	74
8.4.5	Notational Conventions	75
8.4.6	Type Definitions.....	75
8.4.7	RTPS Writer Reference Implementations	76
8.4.8	RTPS StatelessWriter Behavior	88
8.4.9	RTPS StatefulWriter Behavior	95
8.4.10	RTPS Reader Reference Implementations	105
8.4.11	RTPS StatelessReader Behavior	113
8.4.12	RTPS StatefulReader Behavior.....	115
8.4.13	Writer Liveliness Protocol	121
8.4.14	Optional Behavior	123
8.4.15	Implementation Guidelines	125
8.5	Discovery Module.....	127
8.5.1	Overview	127
8.5.2	RTPS built-in Discovery Endpoints	128
8.5.3	The Simple Participant Discovery Protocol	128
8.5.4	The Simple Endpoint Discovery Protocol	134
8.5.5	Interaction with the RTPS virtual machine	140
8.5.6	Supporting Alternative Discovery Protocols	142
8.6	Versioning and Extensibility	142
8.6.1	Allowed Extensions within this major Version	142
8.6.2	What cannot change within this major Version	142
8.7	Implementing DDS QoS and advanced DDS features using RTPS	143

8.7.1	Adding in-line Parameters to Data Submessages.....	143
8.7.2	DDS QoS Parameters	144
8.7.3	Content-filtered Topics	146
8.7.4	Changes in the Instance LifecycleState	149
8.7.5	Coherent Sets.....	149
8.7.6	Directed Write.....	150
8.7.7	Property Lists.....	150
8.7.8	Original Writer Info.....	150
8.7.9	Key Hash	151
9	Platform Specific Model (PSM) : UDP/IP	151
9.1	Introduction.....	151
9.2	Notational Conventions	151
9.2.1	Name Space.....	151
9.2.2	IDL Representation of Structures and CDR Wire Representation... ..	151
9.2.3	Representation of Bits and Bytes	151
9.3	Mapping of the RTPS Types	152
9.3.1	The Globally Unique Identifier (GUID).....	152
9.3.2	Mapping of the Types that Appear Within Submessages or Built-in Topic Data.....	155
9.4	Mapping of the RTPS Messages.....	160
9.4.1	Overall Structure.....	160
9.4.2	Mapping of the PIM SubmessageElements	160
9.4.3	Additional SubmessageElements.....	167
9.4.4	Mapping of the RTPS Header	168
9.4.5	Mapping of the RTPS Submessages	168
9.5	RTPS Message Encapsulation.....	182
9.6	Mapping of the RTPS Protocol.....	182
9.6.1	Default Locators	182
9.6.2	Data representation for the built-in Endpoints	184
9.6.3	ParameterId Definitions used to Represent In-line QoS.....	191
9.6.4	ParameterIds Deprecated by Version 2.1 of the Protocol	196
10	Data Encapsulation	195
10.1	Data Encapsulation.....	195
10.1.1	Standard Data Encapsulation Schemes.....	195
10.1.2	Example.....	197

Preface

About the Object Management Group

OMG

Founded in 1989, the Object Management Group, Inc. (OMG) is an open membership, not-for-profit computer industry standards consortium that produces and maintains computer industry specifications for interoperable, portable and reusable enterprise applications in distributed, heterogeneous environments. Membership includes Information Technology vendors, end users, government agencies and academia.

OMG member companies write, adopt, and maintain its specifications following a mature, open process. OMG's specifications implement the Model Driven Architecture® (MDA®), maximizing ROI through a full-lifecycle approach to enterprise integration that covers multiple operating systems, programming languages, middleware and networking infrastructures, and software development environments. OMG's specifications include: UML® (Unified Modeling Language™); CORBA® (Common Object Request Broker Architecture); CWM™ (Common Warehouse Metamodel); and industry-specific standards for dozens of vertical markets.

More information on the OMG is available at <http://www.omg.org/>.

OMG Specifications

As noted, OMG specifications address middleware, modeling and vertical domain frameworks. A catalog of all OMG Specifications is available from the OMG website at:

http://www.omg.org/technology/documents/spec_catalog.htm

Specifications within the Catalog are organized by the following categories:

OMG Modeling Specifications

- UML
- MOF
- XMI
- CWM
- Profile specifications.

OMG Middleware Specifications

- CORBA/IIOP
- IDL/Language Mappings
- Specialized CORBA specifications
- CORBA Component Model (CCM).

Platform Specific Model and Interface Specifications

- CORBA services

- CORBA facilities
- OMG Domain specifications
- OMG Embedded Intelligence specifications
- OMG Security specifications.

All of OMG's formal specifications may be downloaded without charge from our website. (Products implementing OMG specifications are available from individual suppliers.) Copies of specifications, available in PostScript and PDF format, may be obtained from the Specifications Catalog cited above or by contacting the Object Management Group, Inc. (as of January 16, 2006) at:

OMG Headquarters
140 Kendrick Street
Building A, Suite 300
Needham, MA 02494
USA
Tel: +1-781-444-0404
Fax: +1-781-444-0320
Email: pubs@omg.org

Certain OMG specifications are also available as ISO standards. Please consult <http://www.iso.org>

Intended Audience

This specification is intended primarily for DDS vendors and DDS tools developers. End-users may find the specification useful to monitor network traffic in DDS based applications.

Typographical Conventions

The type styles shown below are used in this document to distinguish programming statements from ordinary English. However, these conventions are not used in tables or section headings where no distinction is necessary.

Times/Times New Roman - 10 pt.: Standard body text

Helvetica/Arial - 10 pt. Bold: OMG Interface Definition Language (OMG IDL) and syntax elements.

Courier - 10 pt. Bold: Programming language elements.

Helvetica/Arial - 10 pt: Exceptions

Note – Terms that appear in *italics* are defined in the glossary. Italic text also represents the name of a document, specification, or other publication.

Issues

Readers are encouraged to report any technical or editing issues/problems with this specification by completing the Issue Reporting Form listed on the main web page <http://www.omg.org>, under Documents, Report a Bug/Issue <http://www.omg.org/technology/agreement.htm>.

1 Scope

This specification is a response to the OMG RFP “Data-Distribution Service Interoperability Wire Protocol” (mars/2005-06-13). It defines an interoperability protocol for DDS. Its purpose and scope is to ensure that applications based on different vendors’ implementations of DDS can interoperate.

2 Conformance

Implementations of this specification must comply with the conformance statements listed in Section 8.4.2 of this specification.

3 Normative References

The following normative documents contain provisions which, through reference in this text, constitute provisions of this specification. For dated references, subsequent amendments to, or revisions of, any of these publications do not apply.

- DDS Specification v1.1 (OMG document formal/2005-12-04)

4 Terms and Definitions

For the purposes of this specification, the terms and definitions given in the normative references apply.

5 Symbols

CDR	Common Data Representation
DDS	Data Distribution Service
EDP	Endpoint Discovery Protocol
GUID	Globally Unique Identifier
PDP	Participant Discovery Protocol
PIM	Platform Independent Model
PSM	Platform Specific Model
RTPS	Real-Time Publish-Subscribe
SEDP	Simple Endpoint Discovery Protocol

6 Additional Information

6.1 Changes to Adopted OMG Specifications

This specification does not change any adopted OMG specifications. It forms a supplement to the OMG DDS specification (see <http://www.omg.org/cgi-bin/doc?formal/05-12-04>).

6.2 How to Read this Specification

This specification defines the DDS Interoperability Protocol. Readers not familiar with DDS will benefit from first reading the DDS specification.

For a very high level overview of RTPS (Real-Time Publish-Subscribe) and a brief description of the structure of this document, please refer to the Introduction. Subsequent chapters cover RTPS in much greater detail.

While providing both a PIM (Platform Independent Model) and a PSM (Platform Specific Model) contributed to the size of this document, this approach also enables a selective reader to easily pick sections of interest:

- Readers who are new to RTPS can start by reading the Structure and Messages Modules of the PIM. These Modules provide an overview of the RTPS protocol actors, how they relate to DDS Entities, what RTPS messages exist and how they are structured.
- Readers who would like to explore the RTPS message exchange protocol can read the first part of the Behavior Module. RTPS is a fairly flexible protocol and allows implementations to customize their behavior depending on how much 'state' they wish to keep on remote Endpoints. The first part of the Behavior Module lists the general requirements any compliant implementation of RTPS must satisfy to remain interoperable with other implementations.
- The second part of the Behavior Module defines two reference implementations. One reference implementation maintains full state on remote Endpoints, the other none. This section may be of interest to readers who want a more detailed understanding of the RTPS message exchange protocol, but it could easily be skipped by first-time readers.
- Readers interested in how RTPS handles dynamic discovery of remote Endpoints are referred to the stand-alone Discovery Module.
- For readers planning on implementing RTPS or defining a new PSM, the PSM Chapter contains a detailed discussion on how the RTPS PIM is mapped to the UDP/IP PSM.
- Finally, the chapter on data encapsulation defines various data encapsulation mechanisms for use with RTPS.

6.3 Acknowledgements

The following companies submitted and/or supported parts of this specification:

- Real-Time Innovations, Inc.
- THALES
- PrismTech

6.4 Statement of Proof of Concept

The protocol specified in this proposal has proven its performance and applicability to data-distribution systems. The protocol is the one used by Real-Time Innovation's implementation of DDS which has been deployed in hundreds of applications worldwide over the last 5 years.

The protocol in this document also forms part of the IEC Real-Time Industrial Ethernet Suite IEC-PAS-62030 IEC standard, showing its applicability to the demanding real-time and resource-constrained industrial-control environment.

The protocol has been independently implemented by other middleware providers such as Schneider Electric and the University of Prague, proving the completeness and self-consistency of the specification.

7 Overview

7.1 Introduction

The recently-adopted Data-Distribution Service specification defines an Application Level Interface and behavior of a Data-Distribution Service (DDS) that supports Data-Centric Publish-Subscribe (DCPS) in real-time systems. The DDS specification used a Model-Driven Architecture (MDA) approach to precisely describe the Data-Centric communications model specifically:

- how the application models the data it wishes to send and receive,
- how the application interacts with the DCPS middleware and specifies the data it wishes to send and receive as well as the quality of service (QoS) requirements,
- how data is sent and received (relative to the QoS requirements),
- how the applications access the data, and
- the kinds of feedback the application gets from the state of the middleware.

The DDS specification also includes a platform specific mapping to IDL and therefore an application using DDS is able to switch among DDS implementations with only a re-compile. DDS therefore addresses ‘application portability.’

The DDS specification does not address the protocol used by the implementation to exchange messages over transports such as TCP/UDP/IP, so different implementations of DDS will not interoperate with each other unless vendor-specific “bridges” are provided. The situation is therefore similar to that of other messaging API standards such as JMS.

With the increasing adoption of DDS in large distributed systems, it is desirable to define a standard “wire protocol” that allows DDS implementations from multiple vendors to interoperate. The desired “DDS wire protocol” should be capable of taking advantage of the QoS settings configurable by DDS to optimize its use of the underlying transport capabilities. In particular, the desired wire protocol must be capable of exploiting the multicast, best-effort, and connectionless nature of many of the DDS QoS settings.

7.2 Requirements for a DDS Wire-protocol

In network communications, as in many other fields of engineering, it is a fact that “one size does not fit all.” Engineering design is about making the right set of trade-offs, and these trade-offs must balance conflicting requirements such as generality, ease of use, richness of features, performance, memory size and usage, scalability, determinism, and robustness. These trade-offs must be made in light of the types of information flow (e.g., periodic vs. bursty, state-based vs. event-based, one-to-many vs. request-reply, best-effort vs. reliable, small data-values vs. large files, etc.), and the constraints imposed by the application and execution platforms. Consequently, many successful protocols have emerged such as HTTP, SOAP, FTP, DHCP, DCE, RTP, DCOM, and CORBA. Each of these protocols fills a niche, providing well-tuned functionality for specific purposes or application domains.

The basic communication model of DDS is one of unidirectional data exchange where the applications that publish data “push” the relevant data updates to the local caches of co-located subscribers to the data. This information flow is regulated by QoS contracts implicitly established between the DataWriters and the DataReaders. The DataWriter specifies its QoS contract at the time it declares its intent to publish data and the DataReader does it at the time it declares its intent to subscribe to data. The communication patterns typically include many-to-many style configurations. Of primary

concern to applications deploying DDS technology is that the information is distributed in an efficient manner with minimal overhead. Another important requirement is the need to scale to hundreds or thousands of subscribers in a robust fault-tolerant manner.

The DDS specification prescribes the presence of a built-in discovery service that allows publishers to dynamically discover the existence of subscribers and vice-versa and performs this task continuously without the need to contact any name servers.

The DDS specification also prescribes that the implementations should not introduce any single points of failure. Consequently protocols must not rely on centralized name servers or centralized information brokers.

The large scale, loosely-coupled, dynamic nature of applications deploying DDS and the need to adapt to emerging transports require certain flexibility on the data-definition and protocol such that each can be evolved while preserving backwards compatibility with already deployed systems.

7.3 The RTPS Wire-protocol

The Real-Time Publish Subscribe (RTPS) protocol found its roots in industrial automation and was in fact approved by the IEC as part of the Real-Time Industrial Ethernet Suite IEC-PAS-62030. It is a field proven technology that is currently deployed worldwide in thousands of industrial devices.

RTPS was specifically developed to support the unique requirements of data-distributions systems. As one of the application domains targeted by DDS, the industrial automation community defined requirements for a standard publish-subscribe wire-protocol that closely match those of DDS. As a direct result, a close synergy exists between DDS and the RTPS wire-protocol, both in terms of the underlying behavioral architecture and the features of RTPS.

The RTPS protocol is designed to be able to run over multicast and connectionless best-effort transports such as UDP/IP. The main features of the RTPS protocol include:

- Performance and quality-of-service properties to enable best-effort and reliable publish-subscribe communications for real-time applications over standard IP networks.
- Fault tolerance to allow the creation of networks without single points of failure.
- Extensibility to allow the protocol to be extended and enhanced with new services without breaking backwards compatibility and interoperability.
- Plug-and-play connectivity so that new applications and services are automatically discovered and applications can join and leave the network at any time without the need for reconfiguration.
- Configurability to allow balancing the requirements for reliability and timeliness for each data delivery.
- Modularity to allow simple devices to implement a subset of the protocol and still participate in the network.
- Scalability to enable systems to potentially scale to very large networks.
- Type-safety to prevent application programming errors from compromising the operation of remote nodes.

The above features make RTPS an excellent match for a DDS wire-protocol. Given its publish-subscribe roots, this is not a coincidence, as RTPS was specifically designed for meeting the types of requirements set forth by the DDS application domain.

This specification defines the message formats, interpretation, and usage scenarios that underlie all messages exchanged by applications that use the RTPS protocol.

7.4 The RTPS Platform Independent Model (PIM)

The RTPS protocol is described in terms of a Platform Independent Model (PIM) and a set of PSMs.

The RTPS PIM contains four modules: Structure, Messages, Behavior, and Discovery. The Structure module defines the communication endpoints. The Messages module defines the set of messages that those endpoints can exchange. The Behavior module defines sets of legal interactions (message exchanges) and how they affect the state of the communication endpoints. In other words, the Structure module defines the protocol “actors,” the Messages module the set of “grammatical symbols,” and the Behavior module the legal grammar and semantics of the different conversations. The Discovery module defines how entities are automatically discovered and configured.

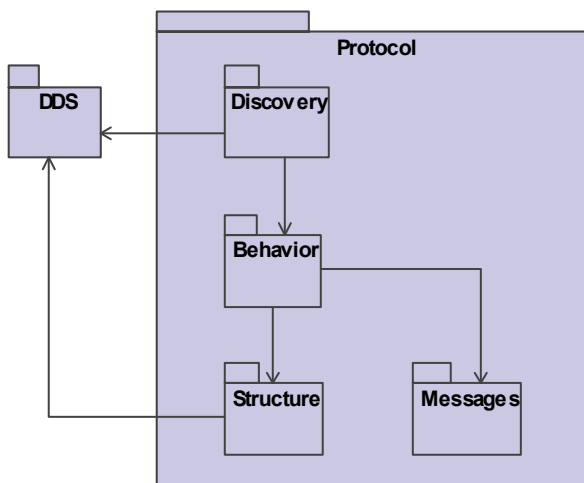

Figure 7.1 - RTPS Modules

In the PIM, the messages are defined in terms of their semantic content. This PIM can then be mapped to various Platform-Specific Models (PSMs) such as plain UDP or CORBA-events.

7.4.1 The Structure Module

Given its publish-subscribe roots, RTPS maps naturally to many DDS concepts. This specification uses many of the same core entities used in the DDS specification. As illustrated in Figure 7.2, all RTPS entities are associated with an RTPS domain, which represents a separate communication plane that contains a set of **Participants**. A Participant contains local **Endpoints**. There are two kinds of endpoints: **Readers** and **Writers**. Readers and Writers are the actors that communicate information by sending RTPS messages. Writers inform of the presence and send locally available data on the **Domain** to the **Readers** which can request and acknowledge the data.

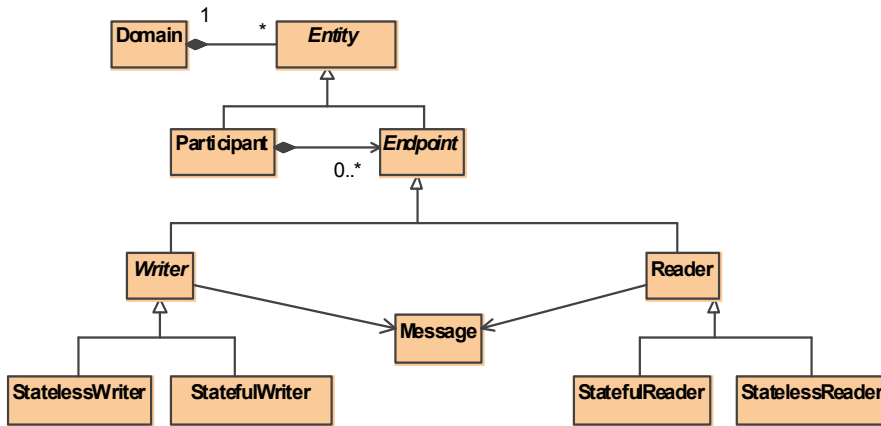

Figure 7.2 - RTPS Structure Module

The Actors in the RTPS Protocol are in one-to-one correspondence with the DDS Entities that are the reason for the communication to occur. This is illustrated in Figure 7.3.

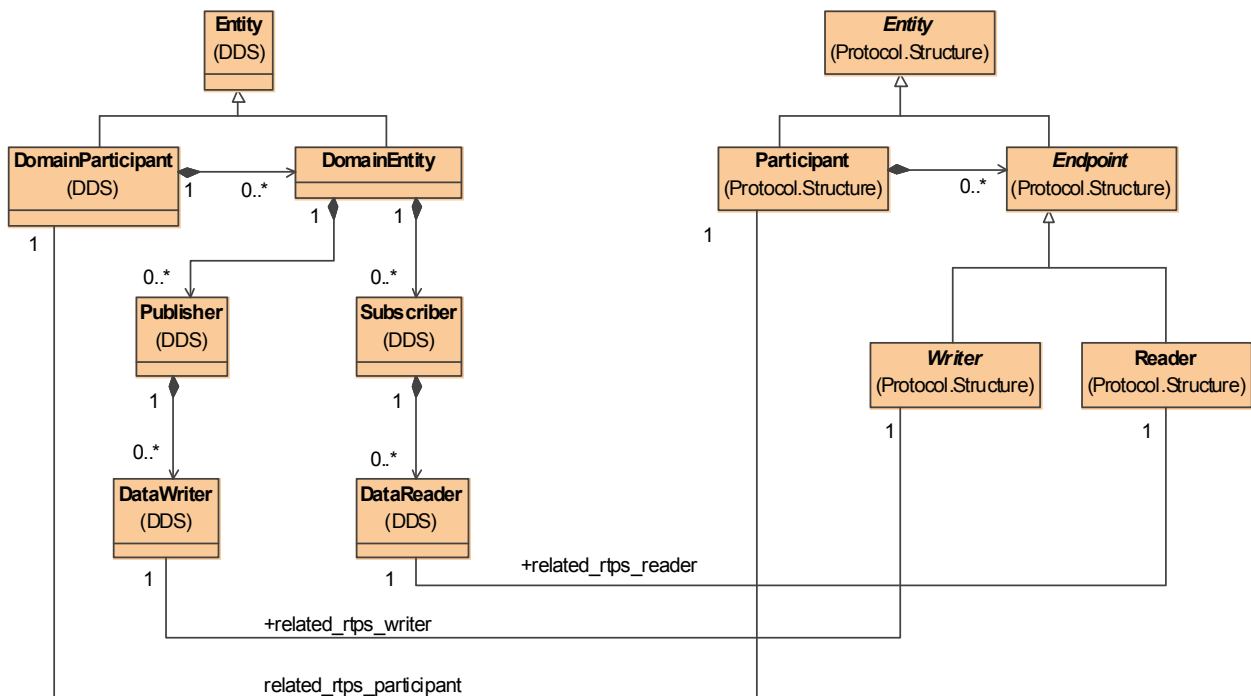

Figure 7.3 - Correspondence between RTPS and DDS Entries

The Structure module is described in Section 8.2.

7.4.2 The Messages Module

The messages module defines the content of the atomic information exchanges between RTPS Writers and Readers. Messages are composed of a header followed by a number of Submessages, as illustrated in Figure 7.4. Each Submessage is built from a series of Submessage elements. This structure is chosen to allow the vocabulary of Submessages and the composition of each Submessage to be extended while maintaining backward compatibility.

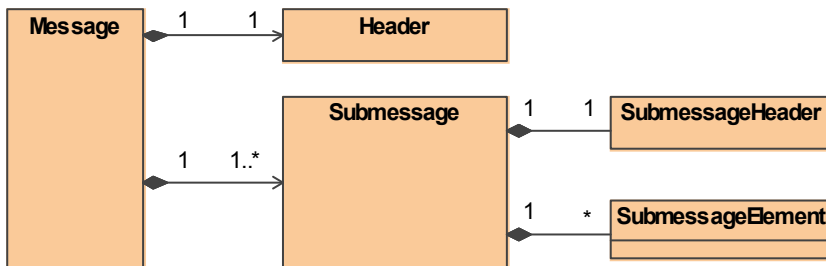

Figure 7.4 - RTPS Messages Module

The Messages module is discussed at length in Section 8.3.

7.4.3 The Behavior Module

The Behavior module describes the allowed sequences of messages that can be exchanged between RTPS Writers and Readers as well as the timings and changes in the state of the Writer and the Reader caused by each message.

The required behavior for interoperability is described in terms of a minimum set of rules that an implementation must follow in order to be interoperable. Actual implementations may exhibit different behavior beyond these minimum requirements, depending on how they wish to trade-off scalability, memory requirements, and bandwidth usage.

To illustrate this concept, the Behavior module defines two reference implementations. One reference implementation is based on **StatefulWriters** and **StatefulReaders**, the other on **StatelessWriters** and **StatelessReaders**, as illustrated in Figure 7.2. Both reference implementations satisfy the minimum requirements for interoperability, and are therefore interoperable, but exhibit slightly different behavior due to the difference in information they store on matching remote entities. The behavior of an actual implementation of the RTPS protocol may be an exact match or a combination of that of the reference implementations.

The Behavior module is described in Section 8.4.

7.4.4 The Discovery Module

The Discovery module describes the protocol that enables **Participants** to obtain information about the existence and attributes of all the other **Participants** and **Endpoints** in the **Domain**. This *metatraffic* enables every **Participant** to obtain a complete picture of all **Participants**, **Readers** and **Writers** in the **Domain** and configure the local Writers to communicate with the remote Readers and the local Readers to communicate with the remote Writers.

Discovery is a separate module. The unique needs of Discovery, namely the transparent plug-and-play dissemination of all the information needed to associate matching Writers and Readers make it unlikely that a single architecture or protocol can fulfill the extremely variable scalability, performance, and embeddability needs of the various heterogeneous networks where DDS will be deployed. Henceforth, it makes sense to introduce several discovery mechanisms ranging from the simple and efficient (but not very scalable), to a more complex hierarchical (but more scalable) mechanism. The Discovery module is described in Section 8.5.

7.5 The RTPS Platform Specific Model (PSM)

A Platform Specific Model maps the RTPS PIM to a specific underlying platform. It defines the precise representation in bits and bytes of all RTPS Types and Messages and any other information specific to the platform.

Multiple PSMs may be supported, but all implementations of DDS must at least implement the PSM on top of UDP/IP, which is presented in Chapter 9.

7.6 The RTPS Transport Model

RTPS supports a wide variety of transports and transport QoS. The protocol is designed to be able to run on multicast and best-effort transports, such as UDP/IP and requires only very simple services from the transport. In fact, it is sufficient that the transport offers a connectionless service capable of sending packets best-effort. That is, the transport need not guarantee each packet will reach its destination or that packets are delivered in-order. Where required, RTPS implements reliability in the transfer of data and state above the transport interface. This does not preclude RTPS from being implemented on top of a reliable transport. It simply makes it possible to support a wider range of transports.

If available, RTPS can also take advantage of the multicast capabilities of the transport mechanism, where one message from a sender can reach multiple receivers. RTPS is designed to promote determinism of the underlying communication mechanism. The protocol provides an open trade-off between determinism and reliability.

The general requirements RTPS poses on the underlying transport can be summarized as follows:

- The transport has a generalized notion of a unicast address (shall fit within 16 bytes).
- The transport has a generalized notion of a port (shall fit within 4 bytes), e.g., could be a UDP port, an offset in a shared memory segment, etc.
- The transport can send a datagram (uninterpreted sequence of octets) to a specific address/port.
- The transport can receive a datagram at a specific address/port.
- The transport will drop messages if incomplete or corrupted during transfer (i.e., RTPS assumes messages are complete and not corrupted).
- The transport provides a means to deduce the size of the received message.

8 Platform Independent Model (PIM)

8.1 Introduction

This chapter defines the Platform Independent Model (PIM) for the RTPS protocol. Subsequent chapters map the PIM to a variety of platforms, the most fundamental one being native UDP packets.

The PIM describes the protocol in terms of a “virtual machine.” The structure of the virtual machine is built from the classes described in Section 8.2, which include Writer and Reader endpoints. These endpoints communicate using the messages described in Section 8.3. Section 8.4 describes the behavior of the virtual machine, i.e., what message exchanges take place between the endpoints. It lists the requirements for interoperability and defines two reference implementations using state-diagrams. Section 8.5 defines the discovery protocol used to configure the virtual machine with the information it needs to communicate with its remote peers. Section 8.6 describes how the protocol can be extended for future needs. Finally, Section 8.7 describes how to implement DDS QoS and some advanced DDS features using RTPS.

The only purpose of introducing the RTPS virtual machine is to describe the protocol in a complete and un-ambiguous manner. This description is not intended to constrain the internal implementation in any way. The only criteria for a compliant implementation is that the externally-observable behavior satisfies the requirements for interoperability. In particular, an implementation could be based on other classes and could use programming constructs other than state-machines to implement the RTPS protocol.

8.2 Structure Module

This section describes the structure of the RTPS entities that are the communication actors. The main classes used by the RTPS protocol are shown in Figure 8.1.

8.2.1 Overview

RTPS entities are the protocol-level endpoints used by the application-visible DDS entities in order to communicate with each other.

Each RTPS *Entity* is in a one-to-one correspondence with a DDS Entity. The *HistoryCache* forms the interface between the DDS Entities and their corresponding RTPS Entities. For example, each write operation on a DDS DataWriter adds a *CacheChange* to the *HistoryCache* of its corresponding RTPS *Writer*. The RTPS *Writer* subsequently transfers the *CacheChange* to the *HistoryCache* of all matching RTPS *Readers*. On the receiving side, the DDS DataReader is notified by the RTPS *Reader* that a new *CacheChange* has arrived in the *HistoryCache*, at which point the DDS DataReader may choose to access it using the DDS read or take API.

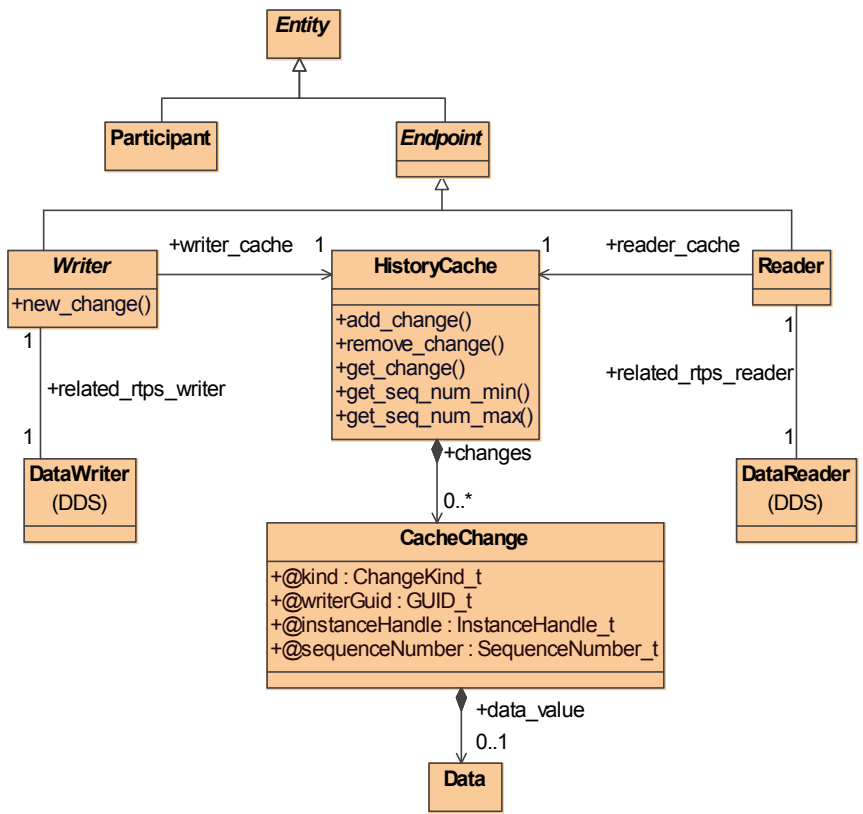

Figure 8.1 - RTPS Structure Module

This section provides an overview of the main classes used by the RTPS virtual machine and the types used to describe their attributes. Subsequent sections describe each class in detail.

8.2.1.1 Summary of the classes used by the RTPS virtual machine

All RTPS entities derive from the RTPS *Entity* class. Table 8.1 lists the classes used by the RTPS virtual machine.

Table 8.1 - Overview of RTPS Entities and Classes

RTPS Entities and Classes	
Class	Purpose
Entity	Base class for all RTPS entities. RTPS <i>Entity</i> represents the class of objects that are visible to other RTPS Entities on the network. As such, RTPS <i>Entity</i> objects have a globally-unique identifier (GUID) and can be referenced inside RTPS messages.
Endpoint	Specialization of RTPS <i>Entity</i> representing the objects that can be communication endpoints. That is, the objects that can be the sources or destinations of RTPS messages.

Table 8.1 - Overview of RTPS Entities and Classes

RTPS Entities and Classes	
Class	Purpose
Participant	Container of all RTPS entities that share common properties and are located in a single address space.
Writer	Specialization of RTPS <i>Endpoint</i> representing the objects that can be the sources of messages communicating <i>CacheChanges</i> .
Reader	Specialization of RTPS <i>Endpoint</i> representing the objects that can be used to receive messages communicating <i>CacheChanges</i> .
HistoryCache	Container class used to temporarily store and manage sets of changes to data-objects. On the Writer side it contains the history of the changes to data-objects made by the Writer. It is not necessary that the full history of all changes ever made is maintained. Rather what is needed is the partial history required to service existing and future matched RTPS <i>Reader</i> endpoints. The partial history needed depends on the DDS QoS and the state of the communications with the matched Reader endpoints. On the Reader side it contains the history of the changes to data-objects made by the matched RTPS <i>Writer</i> endpoints. It is not necessary that the full history of all changes ever received is maintained. Rather what is needed is a partial history containing the superposition of the changes received from the matched writers as needed to satisfy the needs of the corresponding DDS DataReader. The rules for this superposition and the amount of partial history required depend on the DDS QoS and the state of the communication with the matched RTPS Writer endpoints.
CacheChange	Represents an individual change made to a data-object. Includes the creation, modification, and deletion of data-objects.
Data	Represents the data that may be associated with a change made to a data-object.

8.2.1.2 Summary of the types used to describe RTPS Entities and Classes

The Entities and Classes used by the virtual machine each contain a set of attributes. The types of the attributes are summarized in Table 8.2.

Table 8.2 - Types of the attributes that appear in the RTPS Entities and Classes

Types used within the RTPS Entities and Classes	
Attribute type	Purpose
GUID_t	Type used to hold globally-unique RTPS-entity identifiers. These are identifiers used to uniquely refer to each RTPS Entity in the system. Must be possible to represent using 16 octets. The following values are reserved by the protocol: GUID_UNKNOWN

Table 8.2 - Types of the attributes that appear in the RTPS Entities and Classes

Types used within the RTPS Entities and Classes	
Attribute type	Purpose
GuidPrefix_t	Type used to hold the prefix of the globally-unique RTPS-entity identifiers. The GUIDs of entities belonging to the same participant all have the same prefix (see Section 8.2.4.3). Must be possible to represent using 12 octets. The following values are reserved by the protocol: GUIDPREFIX_UNKNOWN
EntityId_t	Type used to hold the suffix part of the globally-unique RTPS-entity identifiers. The EntityId_t uniquely identifies an Entity within a Participant . Must be possible to represent using 4 octets. The following values are reserved by the protocol: ENTITYID_UNKNOWN Additional pre-defined values are defined by the Discovery module in Section 8.5.
SequenceNumber_t	Type used to hold sequence numbers. Must be possible to represent using 64 bits. The following values are reserved by the protocol: SEQUENCENUMBER_UNKNOWN
Locator_t	Type used to represent the addressing information needed to send a message to an RTPS Endpoint using one of the supported transports. Should be able to hold a discriminator identifying the kind of transport, an address, and a port number. It must be possible to represent the discriminator and port number using 4 octets, the address using 16 octets. The following values are reserved by the protocol: LOCATOR_INVALID LOCATOR_KIND_INVALID LOCATOR_KIND_RESERVED LOCATOR_KIND_UDPv4 LOCATOR_KIND_UDPv6 LOCATOR_ADDRESS_INVALID LOCATOR_PORT_INVALID
TopicKind_t	Enumeration used to distinguish whether a Topic has defined some fields within to be used as the ‘key’ that identifies data-instances within the Topic. See the DDS specification for more details on keys. The following values are reserved by the protocol: NO_KEY WITH_KEY
ChangeKind_t	Enumeration used to distinguish the kind of change that was made to a data-object. Includes changes to the data or the lifecycle of the data-object. It can take the values: ALIVE, NOT_ALIVE_DISPOSED, NOT_ALIVE_UNREGISTERED

Table 8.2 - Types of the attributes that appear in the RTPS Entities and Classes

Types used within the RTPS Entities and Classes	
Attribute type	Purpose
ReliabilityKind_t	Enumeration used to indicate the level of the reliability used for communications. It can take the values: BEST_EFFORT, RELIABLE.
InstanceHandle_t	Type used to represent the identity of a data-object whose changes in value are communicated by the RTPS protocol.
ProtocolVersion_t	Type used to represent the version of the RTPS protocol. The version is composed of a major and a minor version number. See also section Section 8.6. The following values are reserved by the protocol: PROTOCOLVERSION PROTOCOLVERSION_1_0 PROTOCOLVERSION_1_1 PROTOCOLVERSION_2_0 PROTOCOLVERSION_2_1 PROTOCOLVERSION is an alias for the most recent version, in this case PROTOCOLVERSION_2_0.
VendorId_t	Type used to represent the vendor of the service implementing the RTPS protocol. The possible values for the <i>vendorId</i> are assigned by the OMG. The following values are reserved by the protocol: VENDORID_UNKNOWN

8.2.1.3 Configuration attributes of the RTPS Entities

RTPS entities are configured by a set of attributes. Some of these attributes map to the QoS policies set on the corresponding DDS entities. Other attributes represent parameters that allow tuning the behavior of the protocol to specific transport and deployment situations. Additional attributes encode the state of the RTPS *Entity* and are not used to configure the behavior.

The attributes used to configure a subset of the RTPS Entities are shown in Figure 8.2. The attributes to configure *Writer* and *Reader* Entities are closely tied to the protocol behavior and will be introduced in Section 8.4.

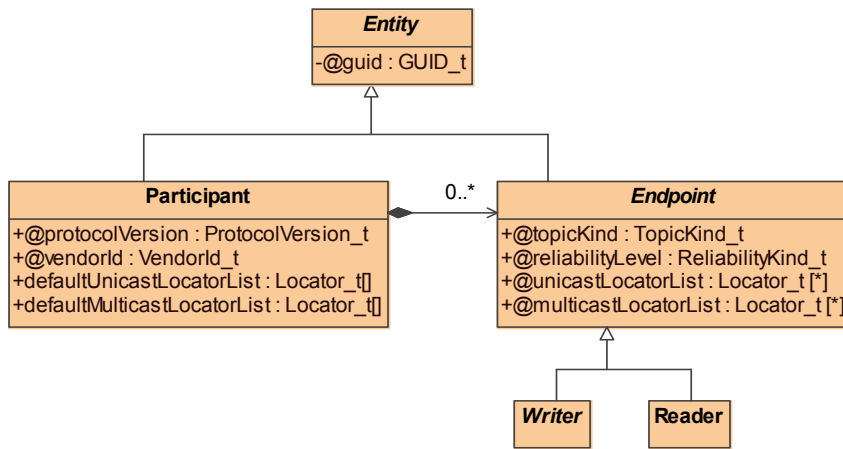

Figure 8.2 - Attributes used to configure the main RTPS Entities

The remainder of this section describes each of the RTPS entities in more detail.

8.2.2 The RTPS HistoryCache

The *HistoryCache* is part of the interface between DDS and RTPS and plays different roles on the reader and the writer side.

On the writer side, the *HistoryCache* contains the partial history of changes to data-objects made by the corresponding DDS *Writer* that are needed to service existing and future matched RTPS *Reader* endpoints. The partial history needed depends on the DDS QoS and the state of the communications with the matched RTPS *Reader* endpoints.

On the reader side, it contains the partial superposition of changes to data-objects made by all the matched RTPS *Writer* endpoints.

The word “partial” is used to indicate that it is not necessary that the full history of all changes ever made is maintained. Rather what is needed is the subset of the history needed to meet the behavioral needs of the RTPS protocol and the QoS needs of the related DDS entities. The rules that define this subset are defined by the RTPS protocol and depend both on the state of the communications protocol and on the QoS of the related DDS entities.

The *HistoryCache* is part of the interface between DDS and RTPS. In other words, both the RTPS entities and their related DDS entities are able to invoke the operations on their associated *HistoryCache*.

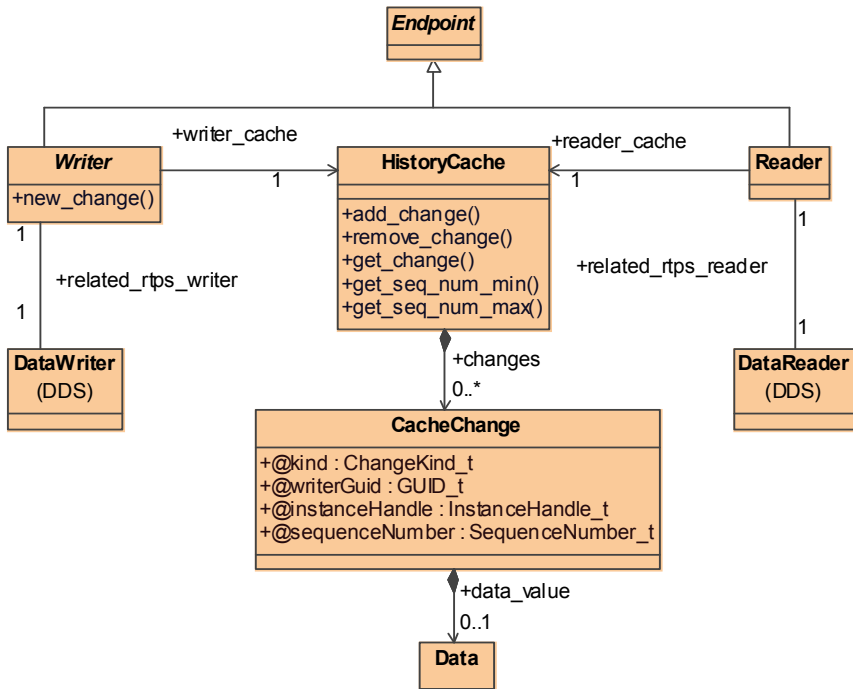

Figure 8.3 - RTPS HistoryCache

The *HistoryCache* attributes are listed in Table 8.3.

Table 8.3 - RTPS HistoryCache Attributes

RTPS HistoryCache			
attribute	type	meaning	relation to DDS
changes	CacheChange[*]	The list of CacheChanges contained in the HistoryCache.	N/A.

The RTPS entities and the related DDS entities interact with the *HistoryCache* using the operations in Table 8.4.

Table 8.4 - RTPS HistoryCache operations

RTPS HistoryCache Operations		
operation name	parameter list	parameter type
new	<return value>	HistoryCache
add_change	<return value>	void
	a_change	CacheChange

Table 8.4 - RTPS HistoryCache operations

RTPS HistoryCache Operations		
<i>operation name</i>	<i>parameter list</i>	<i>parameter type</i>
remove_change	<return value>	void
	a_change	CacheChange
get_seq_num_min	<return value>	SequenceNumber_t
get_seq_num_max	<return value>	SequenceNumber_t

The following sections provide details on the operations.

8.2.2.1 new

This operation creates a new RTPS *HistoryCache*.

The newly-created history cache is initialized with an empty list of changes.

8.2.2.2 add_change

This operation inserts the *CacheChange a_change* into the *HistoryCache*.

This operation will only fail if there are not enough resources to add the change to the *HistoryCache*. It is the responsibility of the DDS service implementation to configure the *HistoryCache* in a manner consistent with the DDS Entity RESOURCE_LIMITS QoS and to propagate any errors to the DDS-user in the manner specified by the DDS specification.

This operation performs the following logical steps:

```
ADD a_change TO this.changes;
```

8.2.2.3 remove_change

This operation indicates that a previously-added *CacheChange* has become irrelevant and the details regarding the *CacheChange* need not be maintained in the *HistoryCache*. The determination of irrelevance is made based on the QoS associated with the related DDS entity and on the acknowledgment status of the *CacheChange*. This is described in Section 8.4.1.

This operation performs the following logical steps:

```
REMOVE a_change FROM this.changes;
```

8.2.2.4 get_seq_num_min

This operation retrieves the smallest value of the CacheChange::sequenceNumber attribute among the *CacheChange* stored in the *HistoryCache*.

This operation performs the following logical steps:

```

min_seq_num := MIN { change.sequenceNumber WHERE (change IN this.changes) }
return min_seq_num;

```

8.2.2.5 get_seq_num_max

This operation retrieves the largest value of the CacheChange::sequenceNumber attribute among the *CacheChange* stored in the *HistoryCache*.

This operation performs the following logical steps:

```

max_seq_num := MAX { change.sequenceNumber WHERE (change IN this.changes) }
return max_seq_num;

```

8.2.3 The RTPS CacheChange

Class used to represent each change added to the *HistoryCache*. The *CacheChange* attributes are listed in Table 8.5.

Table 8.5 - RTPS CacheChange attributes

RTPS CacheChange			
attribute	type	meaning	relation to DDS
kind	ChangeKind_t	Identifies the kind of change. See Table 8.2	DDS instance state kind
writerGuid	GUID_t	The GUID_t that identifies the RTPS Writer that made the change	N/A.
instanceHandle	InstanceHandle_t	Identifies the instance of the data-object to which the change applies.	In DDS, the value of the fields labeled as 'key' within the data uniquely identify each data-object.
sequenceNumber	SequenceNumber_t	Sequence number assigned by the RTPS Writer to uniquely identify the change.	N/A.
data_value	Data	The data value associated with the change. Depending on the <i>kind</i> of CacheChange, there may be no associated data. See Table 8.2.	N/A.

8.2.4 The RTPS Entity

RTPS *Entity* is the base class for all RTPS entities and maps to a DDS Entity. The *Entity* configuration attributes are listed in Table 8.6.

Table 8.6 - RTPS Entity Attributes

RTPS Entity			
attribute	type	meaning	relation to DDS
guid	GUID_t	Globally and uniquely identifies the RTPS <i>Entity</i> within the DDS domain	Maps to the value of the DDS BuiltinTopicKey_t used to describe the corresponding DDS Entity. Refer to the DDS specification for more details.

8.2.4.1 Identifying RTPS entities: The GUID

The GUID (Globally Unique Identifier) is an attribute of all RTPS Entities and uniquely identifies the Entity within a DDS Domain.

The GUID is built as a tuple <prefix, entityId> combining a *GuidPrefix_t* prefix and an *EntityId_t* entityId.

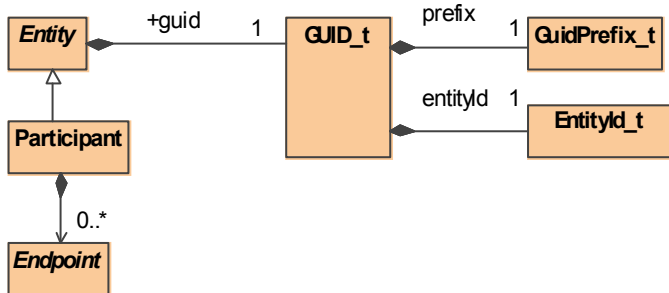

Figure 8.4 - RTPS GUID_t uniquely identifies Entities and is composed of a prefix and a suffix

Table 8.7 - Structure of the GUID_t

field	type	meaning
<i>prefix</i>	GuidPrefix_t	Uniquely identifies the <i>Participant</i> within the Domain.
<i>entityId</i>	EntityId_t	Uniquely identifies the <i>Entity</i> within the <i>Participant</i>

8.2.4.2 The GUIDs of RTPS Participants

Every *Participant* has GUID <prefix, ENTITYID_PARTICIPANT>, where the constant ENTITYID_PARTICIPANT is a special value defined by the RTPS protocol. Its actual value depends on the PSM.

The implementation is free to choose the *prefix*, as long as every *Participant* in the *Domain* has a unique GUID.

8.2.4.3 The GUIDs of the RTPS Endpoints within a Participant

The *Endpoints* contained by a *Participant* with GUID <participantPrefix, ENTITYID_PARTICIPANT> have the GUID <participantPrefix, *entityId*>. The *entityId* is the unique identification of the *Endpoint* relative to the *Participant*. This has several consequences:

- The GUIDs of all the *Endpoints* within a *Participant* have the same *prefix*.
- Once the GUID of an *Endpoint* is known, the GUID of the *Participant* that contains the endpoint is also known.
- The GUID of any endpoint can be deduced from the GUID of the *Participant* to which it belongs and its *entityId*.

The selection of *entityId* for each RTPS *Entity* depends on the PSM.

8.2.5 The RTPS Participant

RTPS *Participant* is the container of RTPS *Endpoint* entities and maps to a DDS DomainParticipant. In addition, the RTPS *Participant* facilitates the fact that the RTPS *Endpoint* entities within a single RTPS *Participant* are likely to share common properties.

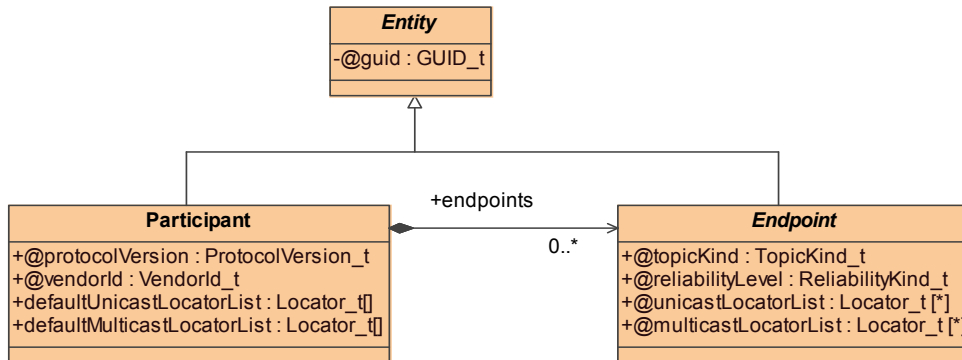

Figure 8.5 - RTPS Participant

RTPS *Participant* contains the attributes shown in Table 8.8.

Table 8.8 - RTPS Participant attributes

RTPS Participant : RTPS Entity			
attribute	type	meaning	relation to DDS
defaultUnicastLocatorList	Locator_t[*]	Default list of unicast locators (transport, address, port combinations) that can be used to send messages to the Endpoints contained in the Participant. These are the unicast locators that will be used in case the Endpoint does not specify its own set of Locators.	N/A. Configured by discovery
defaultMulticastLocatorList	Locator_t[*]	Default list of multicast locators (transport, address, port combinations) that can be used to send messages to the Endpoints contained in the Participant. These are the multicast locators that will be used in case the Endpoint does not specify its own set of Locators.	N/A. Configured by discovery
protocolVersion	ProtocolVersion_t	Identifies the version of the RTPS protocol that the Participant uses to communicate.	N/A. Specified for each version of the protocol.
vendorId	VendorId_t	Identifies the vendor of the RTPS middleware that contains the Participant.	N/A. Configured by each vendor.

8.2.6 The RTPS Endpoint

RTPS *Endpoint* represents the possible communication endpoints from the point of view of the RTPS protocol. There are two kinds of RTPS *Endpoint* entities: *Writer* endpoints and *Reader* endpoints.

RTPS *Writer* endpoints send *CacheChange* messages to RTPS *Reader* endpoints and potentially receive acknowledgments for the changes they send. RTPS *Reader* endpoints receive *CacheChange* and change-availability announcements from *Writer* endpoints and potentially acknowledge the changes and/or request missed changes.

RTPS *Endpoint* contains the attributes shown in Table 8.9.

Table 8.9 - RTPS Endpoint configuration attributes

RTPS Endpoint : RTPS Entity			
attribute	type	meaning	relation to DDS
unicastLocatorList	Locator_t[*]	List of unicast locators (transport, address, port combinations) that can be used to send messages to the <i>Endpoint</i> . The list may be empty.	N/A. Configured by discovery
multicastLocatorList	Locator_t[*]	List of multicast locators (transport, address, port combinations) that can be used to send messages to the <i>Endpoint</i> . The list may be empty.	N/A. Configured by discovery
reliabilityLevel	ReliabilityKind_t	The levels of reliability supported by the <i>Endpoint</i> .	Maps to the RELIABILITY QoS 'kind'.
topicKind	TopicKind_t	Used to indicate whether the <i>Endpoint</i> is associated with a DataType that has defined some fields as containing the DDS key.	Defined by the Data-type that is associated with the DDS Topic related to the RTPS <i>Endpoint</i> .

8.2.7 The RTPS Writer

RTPS *Writer* specializes RTPS *Endpoint* and represents the actor that sends *CacheChange* messages to the matched RTPS *Reader* endpoints. Its role is to transfer all *CacheChange* changes in its *HistoryCache* to the *HistoryCache* of the matching remote RTPS *Readers*.

The attributes to configure an RTPS *Writer* are closely tied to the protocol behavior and will be introduced in the Behavior Module (Section 8.4).

8.2.8 The RTPS Reader

RTPS *Reader* specializes RTPS *Endpoint* and represents the actor that receives *CacheChange* messages from the matched RTPS *Writer* endpoints.

The attributes to configure an RTPS *Reader* are closely tied to the protocol behavior and will be introduced in the Behavior Module (Section 8.4).

8.2.9 Relation to DDS Entities

As mentioned in Section 8.2.2, the *HistoryCache* forms the interface between DDS Entities and their corresponding RTPS Entities. A DDS DataWriter, for example, passes data to its matching RTPS *Writer* through the common *HistoryCache*.

How exactly a DDS Entity interacts with the *HistoryCache* however, is implementation specific and not formally modelled by the RTPS protocol. Instead, the Behavior Module of the RTPS protocol *only* specifies how *CacheChange* changes are transferred from the *HistoryCache* of the RTPS *Writer* to the *HistoryCache* of each matching RTPS *Reader*.

Despite the fact that it is not part of the RTPS protocol, it is important to know how a DDS Entity may interact with the *HistoryCache* to obtain a complete understanding of the protocol. This topic forms the subject of this section.

The interactions are described using UML state diagrams. The abbreviations used to refer to DDS and RTPS Entities are listed in Table 8.10 below.

Table 8.10 - Abbreviations used in the sequence charts and state diagrams

Acronym	Meaning	Example usage
DW	DDS DataWriter	DW::write
DR	DDS DataReader	DR::read
W	RTPS Writer	W::heartbeatPeriod
R	RTPS Reader	R::heartbeatResponseDelay
WHC	HistoryCache of RTPS Writer	WHC::changes
RHC	HistoryCache of RTPS Reader	RHC::changes

8.2.9.1 The DDS DataWriter

The write operation on a DDS DataWriter adds *CacheChange* changes to the *HistoryCache* of its associated RTPS Writer. As such, the *HistoryCache* contains a history of the most recently written changes. The number of changes is determined by QoS settings on the DDS DataWriter such as the HISTORY and RESOURCE_LIMITS QoS.

By default, all changes in the *HistoryCache* are considered relevant for each matching remote RTPS *Reader*. That is, the *Writer* should attempt to send all changes in the *HistoryCache* to the matching remote *Readers*. How to do this is the subject of the Behavior Module of the RTPS protocol.

Changes may not be sent to a remote *Reader* for two reasons:

- they have been removed from the *HistoryCache* by the DDS DataWriter and are no longer available.
- they are considered irrelevant for this *Reader*.

The DDS DataWriter may decide to remove changes from the *HistoryCache* for several reasons. For example, only a limited number of changes may need to be stored based on the HISTORY QoS settings. Alternatively, a sample may have expired due to the LIFESPAN QoS. When using strict reliable communication, a change can only be removed when it has been acknowledged by all readers the change was sent to and which are still active and alive.

Not all changes may be relevant for each matching remote *Reader*, as determined by for example the TIME_BASED_FILTER QoS or through the use of DDS content-filtered topics. Note that whether a change is relevant must be determined on a per *Reader* basis in this case. Implementations may be able to optimize bandwidth and/or CPU usage by filtering on the *Writer* side when possible. Whether this is possible depends on whether an implementation keeps track of each individual remote *Reader* and the QoS and filters that apply to this *Reader*. The *Reader* itself will always filter.

QoS or content based filtering is represented in this document using **DDS_FILTER(reader, change)**, a notation which reflects that filtering is reader dependent. Depending on what reader specific information is stored by the writer, DDS_FILTER may be a noop. For content based filtering, the RTPS specification enables sending information with each change that lists what filters have been applied to the change and which filters it passed. If available, this information can then be used by the **Reader** to filter a change without having to call DDS_FILTER. This approach saves CPU cycles by filtering the sample once on the **Writer** side, as opposed to filtering on each **Reader**.

The following state-diagram illustrates how the DDS Data Writer adds a change to the **HistoryCache**.

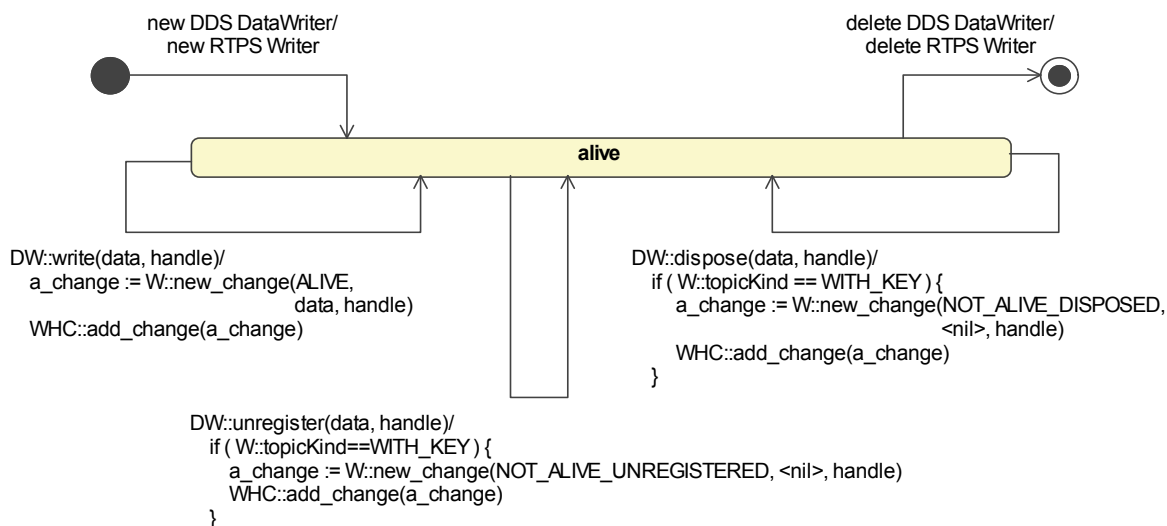

Figure 8.6 - DDS DataWriter additions to the HistoryCache

Table 8.11 - Transitions for DDS DataWriter additions to the HistoryCache

Transition	state	event	next state
T1	initial	new DDS DataWriter	alive
T2	alive	DataWriter::write	alive
T3	alive	DataWriter::dispose	alive
T4	alive	DataWriter::unregister	alive
T5	alive	delete DDS DataWriter	final

8.2.9.1.1 Transition T1

This transition is triggered by the creation of a DDS DataWriter ‘the_dds_writer.’ The transition performs the following logical actions in the virtual machine:

```

the_rtps_writer = new RTPS::Writer;
the_dds_writer.related_rtps_writer := the_rtps_writer;
  
```

8.2.9.1.2 Transition T2

This transition is triggered by the act of writing data using a DDS DataWriter ‘the_dds_writer’. The DataWriter::write() operation takes as arguments the ‘data’ and the InstanceHandle_t ‘handle’ used to differentiate among different data-objects.

The transition performs the following logical actions in the virtual machine:

```
the_rtps_writer := the_dds_writer.related_rtps_writer;
a_change := the_rtps_writer.new_change(ALIVE, data, handle);
the_rtps_writer.writer_cache.add_change(a_change);
```

After the transition the following post-conditions hold:

```
the_rtps_writer.writer_cache.get_seq_num_max() == a_change.sequenceNumber
```

8.2.9.1.3 Transition T3

This transition is triggered by the act of disposing a data-object previously written with the DDS DataWriter ‘the_dds_writer.’ The DataWriter::dispose() operation takes as parameter the InstanceHandle_t ‘handle’ used to differentiate among different data-objects.

This operation has no effect if the topicKind==NO_KEY.

The transition performs the following logical actions in the virtual machine:

```
the_rtps_writer := the_dds_writer.related_rtps_writer;
if (the_rtps_writer.topicKind == WITH_KEY) {
    a_change := the_rtps_writer.new_change(NOT_ALIVE_DISPOSED, <nil>, handle);
    the_rtps_writer.writer_cache.add_change(a_change);
}
```

After the transition the following post-conditions hold:

```
if (the_rtps_writer.topicKind == WITH_KEY) then
    the_rtps_writer.writer_cache.get_seq_num_max() == a_change.sequenceNumber
```

8.2.9.1.4 Transition T4

This transition is triggered by the act of unregistering a data-object previously written with the DDS DataWriter ‘the_dds_writer.’ The DataWriter::unregister() operation takes as arguments the InstanceHandle_t ‘handle’ used to differentiate among different data-objects.

This operation has no effect if the topicKind==NO_KEY.

The transition performs the following logical actions in the virtual machine:

```
the_rtps_writer := the_dds_writer.related_rtps_writer;
if (the_rtps_writer.topicKind == WITH_KEY) {
    a_change := the_rtps_writer.new_change(NOT_ALIVE_UNREGISTERED, <nil>, handle);
    the_rtps_writer.writer_cache.add_change(a_change);
}
```

After the transition the following post-conditions hold:

```
if (the_rtps_writer.topicKind == WITH_KEY) then
    the_rtps_writer.writer_cache.get_seq_num_max() == a_change.sequenceNumber
```

8.2.9.1.5 Transition T5

This transition is triggered by the destruction of a DDS DataWriter ‘the_dds_writer.’

The transition performs the following logical actions in the virtual machine:

```
delete the_dds_writer.related_rtps_writer;
```

8.2.9.2 The DDS DataReader

The DDS DataReader gets its data from the *HistoryCache* of the corresponding RTPS *Reader*. The number of changes stored in the *HistoryCache* is determined by QoS settings such as the HISTORY and RESOURCE_LIMITS QoS.

Each matching *Writer* will attempt to transfer all relevant samples from its *HistoryCache* to the *HistoryCache* of the *Reader*. The implementation of the read or take call on the DDS DataReader accesses the *HistoryCache*. The changes returned to the user are those in the *HistoryCache* that pass all *Reader* specific filters, if any.

A *Reader* filter is equally represented by `DDS_FILTER(reader, change)`. As mentioned above, implementations may be able to perform most of the filtering on the *Writer* side. In that case, samples are either never sent (and therefore not present in the *HistoryCache* of the *Reader*) or contain information on what filters were applied and the corresponding outcome (for content based filtering).

A DDS DataReader may also decide to remove changes from the *HistoryCache* in order to satisfy such QoS as TIME_BASED_FILTER. This exact behavior is again implementation specific and is not modeled by the RTPS protocol.

The following state-diagram illustrates how the DDS Data Reader accesses changes in the *HistoryCache*.

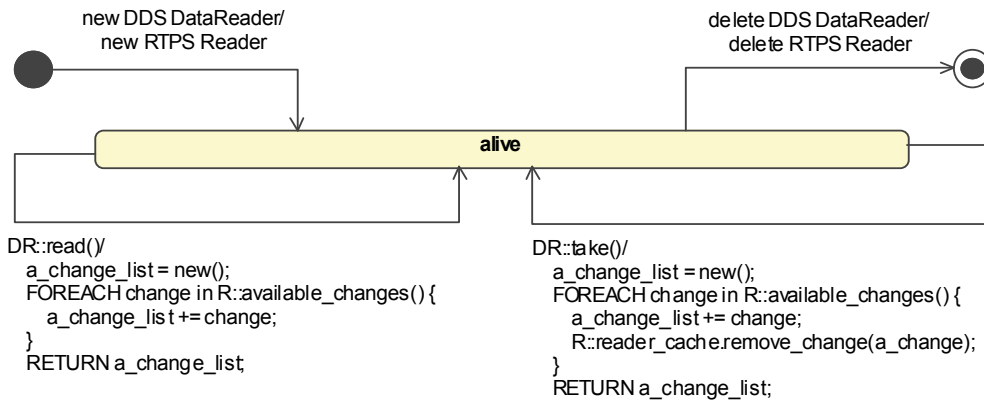

Figure 8.7 - DDS DataReader access to the HistoryCache

Table 8.12 - Transitions for DDS DataReader access to the HistoryCache

Transition	state	event	next state
T1	initial	new DDS DataReader	alive

Table 8.12 - Transitions for DDS DataReader access to the HistoryCache

Transition	state	event	next state
T2	alive	DDS DataReader::read	alive
T3	alive	DDS DataReader::take	alive
T4	alive	delete DDS DataReader	final

8.2.9.2.1 Transition T1

This transition is triggered by the creation of a DDS DataReader ‘the_dds_reader.’

The transition performs the following logical actions in the virtual machine:

```
the_rtps_reader = new RTPS::Reader;
the_dds_reader.related_rtps_reader := the_rtps_reader;
```

8.2.9.2.2 Transition T2

This transition is triggered by the act of reading data from the DDS DataReader ‘the_dds_reader’ by means of the ‘read’ operation. Changes returned to the application remain in the RTPS *Reader’s HistoryCache* such that subsequent read or take operations can find them again.

The transition performs the following logical actions in the virtual machine:

```
the_rtps_reader := the_dds_reader.related_rtps_reader;
a_change_list := new();
FOREACH change IN the_rtps_reader.reader_cache.changes {
    if DDS_FILTER(the_rtps_reader, change) ADD change TO a_change_list;
}
RETURN a_change_list;
```

The DDS_FILTER() operation reflects the capabilities of the DDS DataReader API to select a subset of changes based on *CacheChange::kind*, QoS, content-filters and other mechanisms. Note that the logical actions above only reflect the behavior and not necessarily the actual implementation of the protocol.

8.2.9.2.3 Transition T3

This transition is triggered by the act of reading data from the DDS DataReader ‘the_dds_reader’ by means of the ‘take’ operation. Changes returned to the application are removed from the RTPS *Reader’s HistoryCache* such that subsequent read or take operations do not find the same change.

The transition performs the following logical actions in the virtual machine:

```
the_rtps_reader := the_dds_reader.related_rtps_reader;
a_change_list := new();
FOREACH change IN the_rtps_reader.reader_cache.changes {
    if DDS_FILTER(the_rtps_reader, change) {
        ADD change TO a_change_list;
    }
    the_rtps_reader.reader_cache.remove_change(a_change);
}
RETURN a_change_list;
```

The `DDS_FILTER()` operation reflects the capabilities of the DDS DataReader API to select a subset of changes based on *CacheChange::kind*, QoS, content-filters and other mechanisms. Note that the logical actions above only reflect the behavior and not necessarily the actual implementation of the protocol.

After the transition the following post-conditions hold:

```
FOREACH change IN a_change_list
    change BELONGS_TO the_rtps_reader.reader_cache.changes == FALSE
```

8.2.9.2.4 Transition T4

This transition is triggered by the destruction of a DDS DataReader ‘the_dds_reader.’

The transition performs the following logical actions in the virtual machine:

```
delete the_dds_reader.related_rtps_reader;
```

8.3 Messages Module

The Messages module describes the overall structure and logical contents of the messages that are exchanged between the RTPS *Writer* endpoints and RTPS *Reader* endpoints. RTPS Messages are modular by design and can be easily extended to support both standard protocol feature additions as well as vendor-specific extensions.

8.3.1 Overview

The Messages module is organized as follows:

- Section 8.3.2 introduces any additional types needed for defining RTPS messages in the subsequent sections.
- Section 8.3.3 describes the common structure used for all RTPS Messages. All RTPS Messages consist of a Header followed by a series of Submessages. The number of Submessages that can be sent in a single RTPS Message is only limited by the maximum message size the underlying transport can support.
- Certain Submessages may affect how subsequent Submessages within the same RTPS Message must be interpreted. The context for interpreting Submessages is maintained by the RTPS Message Receiver and is described in Section 8.3.4.
- Section 8.3.5 lists the elementary building blocks for creating Submessages, also referred to as SubmessageElements. This includes sequence number sets, timestamp, identifiers, etc.
- Section 8.3.6 describes the structure of the RTPS Header. The fixed size RTPS Header is used to identify an RTPS Message.
- Finally, Section 8.3.7 introduces all available Submessages in detail. For each Submessage, the specification defines its contents, when it is considered valid and how it affects the state of the RTPS Message Receiver. The PSM will define the actual mapping of each of these Submessage to bits and bytes on the wire in Section 9.4.5.

8.3.2 Type Definitions

In addition to the types defined in Section 8.2.1.2, the Messages module makes use of the types listed in Table 8.13.

Table 8.13 - Types used to define RTPS messages

Types used to define RTPS messages	
Type	Purpose
ProtocolId_t	Enumeration used to identify the protocol. The following values are reserved by the protocol: PROTOCOL_RTPS
SubmessageFlag	Type used to specify a Submessage flag. A Submessage flag takes a boolean value and affects the parsing of the Submessage by the receiver.
SubmessageKind	Enumeration used to identify the kind of Submessage. The following values are reserved by this version 2.0 of the protocol: NOKEY_DATA , DATA, GAP, HEARTBEAT, ACKNACK, PAD, INFO_TS, INFO_REPLY, INFO_DST, INFO_SRC, DATA_FRAG, NOKEY_DATA_FRAG , NACK_FRAG, HEARTBEAT_FRAG
Time_t	Type used to hold a timestamp. Should have at least nano-second resolution. The following values are reserved by the protocol: TIME_ZERO TIME_INVALID TIME_INFINITE
Count_t	Type used to encapsulate a count that is incremented monotonically, used to identify message duplicates.
KeyHashPrefix_t	Type used to (optionally) specify part of the instance identifier for a particular instance of a keyed topic. If not specified, defaults to the <i>GuidPrefix_t</i> of the <i>Participant</i> whose <i>Writer</i> wrote the instance. This approach minimizes the information that must be sent to the <i>Reader</i> to identify an instance. Must be possible to represent using 12 octets.
KeyHashSuffix_t	Type used to specify part of the instance identifier for a particular instance of a keyed topic. Must be possible to represent using 4 octets.
ParameterId_t	Type used to uniquely identify a parameter in a parameter list. Used extensively by the Discovery Module mainly to define QoS Parameters. A range of values is reserved for protocol-defined parameters, while another range can be used for vendor-defined parameters, see Section 8.3.5.9.
FragmentNumber_t	Type used to hold fragment numbers. Must be possible to represent using 32 bits.

8.3.3 The Overall Structure of an RTPS Message

The overall structure of an RTPS **Message** consists of a fixed-size leading RTPS **Header** followed by a variable number of RTPS **Submessage** parts. Each **Submessage** in turn consists of a **SubmessageHeader** and a variable number of **SubmessageElements**. This is illustrated in Figure 8.8.

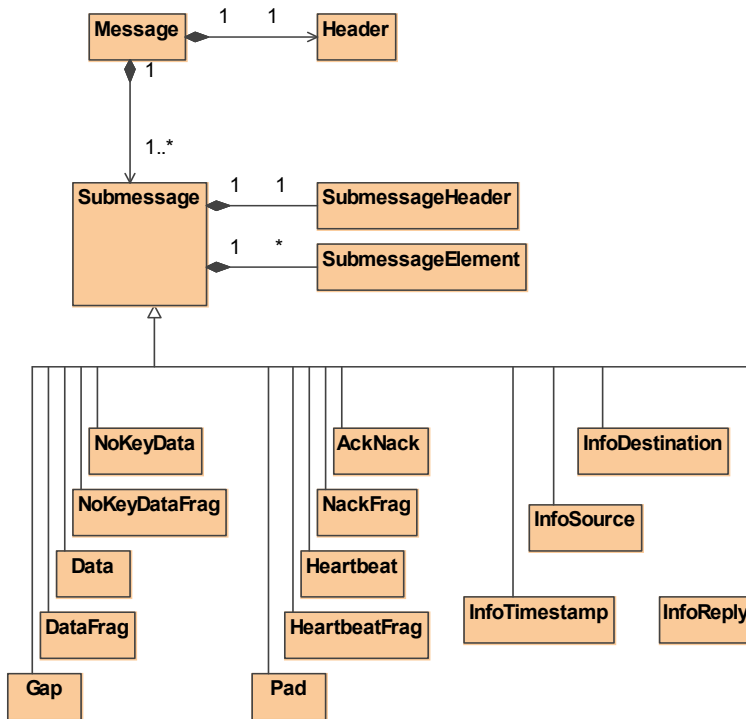

Figure 8.8 - Structure of RTPS Messages

Each message sent by the RTPS protocol has a finite length. This length is not sent explicitly by the RTPS protocol but is part of the underlying transport with which RTPS messages are sent. In the case of a packet-oriented transport (like UDP/IP), the length of the message is already provided by the transport encapsulation. A stream-oriented transport (like TCP) would need to insert the length ahead of the message in order to identify the boundary of the RTPS message.

8.3.3.1 Header structure

The RTPS **Header** must appear at the beginning of every message.

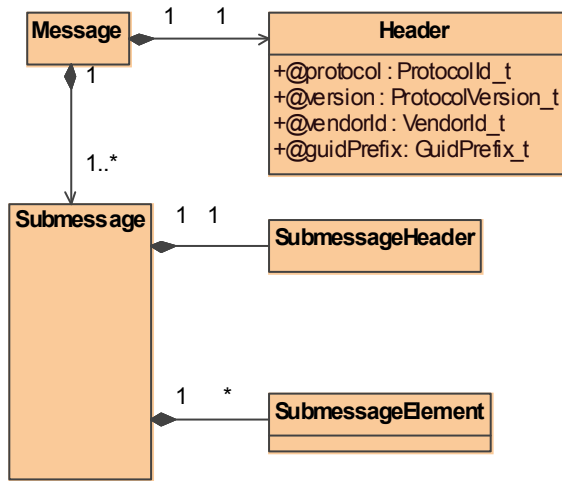

Figure 8.9 - Structure of the RTPS Message Header

The **Header** identifies the message as belonging to the RTPS protocol. The **Header** identifies the version of the protocol and the vendor that sent the message. The **Header** contains the fields listed in Table 8.14.

Table 8.14 - Structure of the Header

field	type	meaning
<i>protocol</i>	ProtocolId_t	Identifies the message as an RTPS message.
<i>version</i>	ProtocolVersion_t	Identifies the version of the RTPS protocol.
<i>vendorId</i>	VendorId_t	Indicates the vendor that provides the implementation of the RTPS protocol.
<i>guidPrefix</i>	GuidPrefix_t	Defines a default prefix to use for all GUIDs that appear in the message.

The structure of the RTPS **Header** cannot be changed in this major version (2) of the protocol.

8.3.3.1.1 protocol

The *protocol* identifies the message as an RTPS message. This value is set to PROTOCOL_RTPS.

8.3.3.1.2 version

The *version* identifies the version of the RTPS protocol. Implementations following this version of the document implement protocol version 2.1 (major = 2, minor = 0₁) and have this field set to PROTOCOLVERSION_2_1-2_0.

8.3.3.1.3 vendorId

The *vendorId* identifies the vendor of the middleware that implemented the RTPS protocol and allows this vendor to add specific extensions to the protocol. The *vendorId* does not refer to the vendor of the device or product that contains RTPS middleware. The possible values for the *vendorId* are assigned by the OMG.

The protocol reserves the following value:

VENDORID_UNKNOWN

8.3.3.1.4 guidPrefix

The *guidPrefix* defines a default prefix that can be used to reconstruct the Globally Unique Identifiers (GUIDs) that appear within the Submessages contained in the message. The *guidPrefix* allows Submessages to contain only the EntityId part of the GUID and therefore saves from having to repeat the common prefix on every GUID (See Section 8.2.4.1).

8.3.3.2 Submessage structure

Each RTPS **Message** consists of a variable number of RTPS **Submessage** parts. All RTPS Submessages feature the same identical structure shown in Figure 8.10.

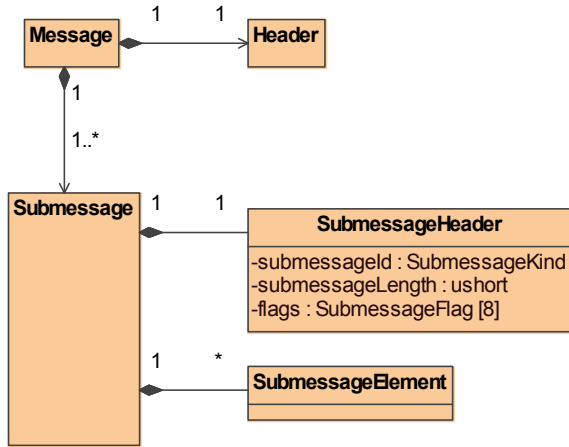

Figure 8.10 - Structure of the RTPS Submessages

All Submessages start with a **SubmessageHeader** part followed by a concatenation of **SubmessageElement** parts. The **SubmessageHeader** identifies the kind of Submessage and the optional elements within that Submessage. The **SubmessageHeader** contains the fields listed in Table 8.15.

Table 8.15 - Structure of the SubmessageHeader

field	type	meaning
<i>submessageId</i>	SubmessageKind	Identifies the kind of Submessage. The possible Submessages are described in Section 8.3.7.

Table 8.15 - Structure of the SubmessageHeader

field	type	meaning
<i>flags</i>	SubmessageFlag[8]	Identifies the endianness used to encapsulate the Submessage, the presence of optional elements within the Submessage, and possibly modifies the interpretation of the Submessage. There are 8 possible flags. The first flag (index 0) identifies the endianness used to encapsulate the Submessage. The remaining flags are interpreted differently depending on the kind of Submessage and are described separately for each Submessage.
<i>submessageLength</i>	ushort	Indicates the length of the Submessage. Given an RTPS Message consists of a concatenation of Submessages, the Submessage length can be used to skip to the next Submessage.

The structure of the RTPS **Submessage** cannot be changed in this major version (2) of the protocol.

8.3.3.2.1 SubmessageId

The *submessageId* identifies the kind of **Submessage**. The valid ID's are enumerated by the possible values of SubmessageKind (see Table 8.13).

The meaning of the Submessage IDs cannot be modified in this major version (2). Additional Submessages can be added in higher minor versions. In order to maintain inter-operability with future versions, Platform Specific Mappings should reserve a range of values intended for protocol extensions and a range of values that are reserved for vendor-specific Submessages that will never be used by future versions of the RTPS protocol.

8.3.3.2.2 flags

The *flags* in the Submessage header contain 8 boolean values. The first flag, the *EndiannessFlag*, is present and located in the same position in all Submessages and represents the endianness used to encode the information in the **Submessage**. The literal 'E' is often used to refer to the *EndiannessFlag*.

If the *EndiannessFlag* is set to FALSE, the **Submessage** is encoded in big-endian format, *EndiannessFlag* set to TRUE means little-endian.

Other flags have interpretations that depend on the type of **Submessage**.

8.3.3.2.3 submessageLength

Indicates the length of the Submessage (not including the Submessage header).

In case *submessageLength* > 0, it is either

- The length from the start of the contents of the Submessage until the start of the header of the next **Submessage** (in case the **Submessage** is not the last **Submessage** in the **Message**).
- Or else it is the remaining **Message** length (in case the **Submessage** is the last **Submessage** in the **Message**). An interpreter of the **Message** can distinguish between these two cases as it knows the total length of the **Message**.

In case *submessageLength*==0, the **Submessage** is the last **Submessage** in the **Message** and extends up to the end of the **Message**. This makes it possible to send Submessages larger than 64k (the maximum length that can be stored in the *submessageLength* field), provided they are the last **Submessage** in the **Message**.

8.3.4 The RTPS Message Receiver

The interpretation and meaning of a **Submessage** within a **Message** may depend on the previous **Submessages** contained within that same **Message**. Therefore, the receiver of a **Message** must maintain state from previously deserialized **Submessages** in the same **Message**. This state is modeled as the state of an RTPS **Receiver** that is reset each time a new message is processed and provides context for the interpretation of each Submessage. The RTPS Receiver is shown in Figure 8.11. Table 8.16 lists the attributes used to represent the state of the RTPS Receiver.

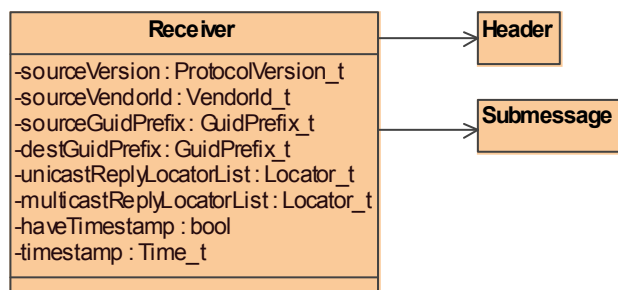

Figure 8.11 - RTPS Receiver

For each new **Message**, the state of the Receiver is reset and initialized as listed below.

Table 8.16 - Initial State of the Receiver

name	initial value
<i>sourceVersion</i>	PROTOCOLVERSION_2_0 PROTOCOLVERSION
<i>sourceVendorId</i>	VENDORID_UNKNOWN
<i>sourceGuidPrefix</i>	GUIDPREFIX_UNKNOWN
<i>destGuidPrefix</i>	GUID prefix of the participant receiving the message
<i>UnicastReplyLocatorList</i>	The list is initialized to contain a single Locator_t with the LocatorKind, Address and Port fields specified below: The LocatorKind is set to the kind that identifies the transport that received the message (e.g., LOCATOR_KIND_UDPv4). The Address is set to the Address of the source of the message, assuming the Transport used supports this (e.g., for UDP the source address is part of the UDP header). Otherwise it is set to LOCATOR_ADDRESS_INVALID. The port is set to LOCATOR_PORT_INVALID.

Table 8.16 - Initial State of the Receiver

name	initial value
<i>multicastReplyLocatorList</i>	The list is initialized to contain a single Locator_t with the LocatorKind, an Address and Port fields specified below: The LocatorKind is set to the kind that identifies the transport that received the message (e.g., LOCATOR_KIND_UDPv4). The address is set to LOCATOR_ADDRESS_INVALID. The port is set to LOCATOR_PORT_INVALID.
<i>haveTimestamp</i>	FALSE
<i>timestamp</i>	TIME_INVALID

8.3.4.1 Rules Followed by the Message Receiver

The following algorithm outlines the rules that a receiver of any **Message** must follow:

1. If the full **Submessage** header cannot be read, the rest of the **Message** is considered invalid.
2. The *submessageLength* field defines where the next **Submessage** starts or indicates that the **Submessage** extends to the end of the **Message**, as explained in Section 8.3.3.2.3, “submessageLength,” on page 34. If this field is invalid, the rest of the **Message** is invalid.
3. A **Submessage** with an unknown SubmessageId must be ignored and parsing must continue with the next **Submessage**. Concretely: an implementation of RTPS 2.1 must ignore any **Submessages** with IDs that are outside of the **SubmessageKind** set defined in version 2.1. SubmessageIds in the vendor-specific range coming from a *vendorId* that is unknown must also be ignored and parsing must continue with the next **Submessage**.
4. **Submessage** flags. The receiver of a Submessage should ignore unknown flags. An implementation of RTPS 2.1 should skip all flags that are marked as “X” (unused) in the protocol.
5. A valid *submessageLength* field must *always* be used to find the next **Submessage**, even for **Submessages** with known IDs.
6. A known but invalid **Submessage** invalidates the rest of the **Message**. Section 8.3.7 describes each known **Submessage** and when it should be considered invalid.

Reception of a valid header and/or Submessage has two effects:

- It can change the state of the Receiver; this state influences how the following **Submessages** in the **Message** are interpreted. Section 8.3.7 discusses how the state changes for each **Submessage**. In this version of the protocol, only the **Header** and the **Submessages InfoSource, InfoReply, InfoDestination, and InfoTimestamp** change the state of the Receiver.
- It can affect the behavior of the Endpoint to which the message is destined. This applies to the basic RTPS messages: **NoKeyData, Data, NoKeyDataFrag, DataFrag, HeartBeat, AckNack, Gap, HeartbeatFrag, NackFrag**.

Section 8.3.7 describes the detailed interpretation of the **Header** and every **Submessage**.

8.3.5 RTPS SubmessageElements

Each RTPS message contains a variable number of RTPS Submessages. Each RTPS Submessage in turn is built from a set of predefined atomic building blocks called **SubmessageElements**. RTPS 2.1 defines the following Submessage elements: **GuidPrefix**, **EntityId**, ~~**KeyHashPrefix**~~, ~~**KeyHashSuffix**~~, **SequenceNumber**, **SequenceNumberSet**, **FragmentNumber**, **FragmentNumberSet**, **VendorId**, **ProtocolVersion**, **LocatorList**, **Timestamp**, **Count**, ~~**StatusInfo**~~, **SerializedData**, and **ParameterList**.

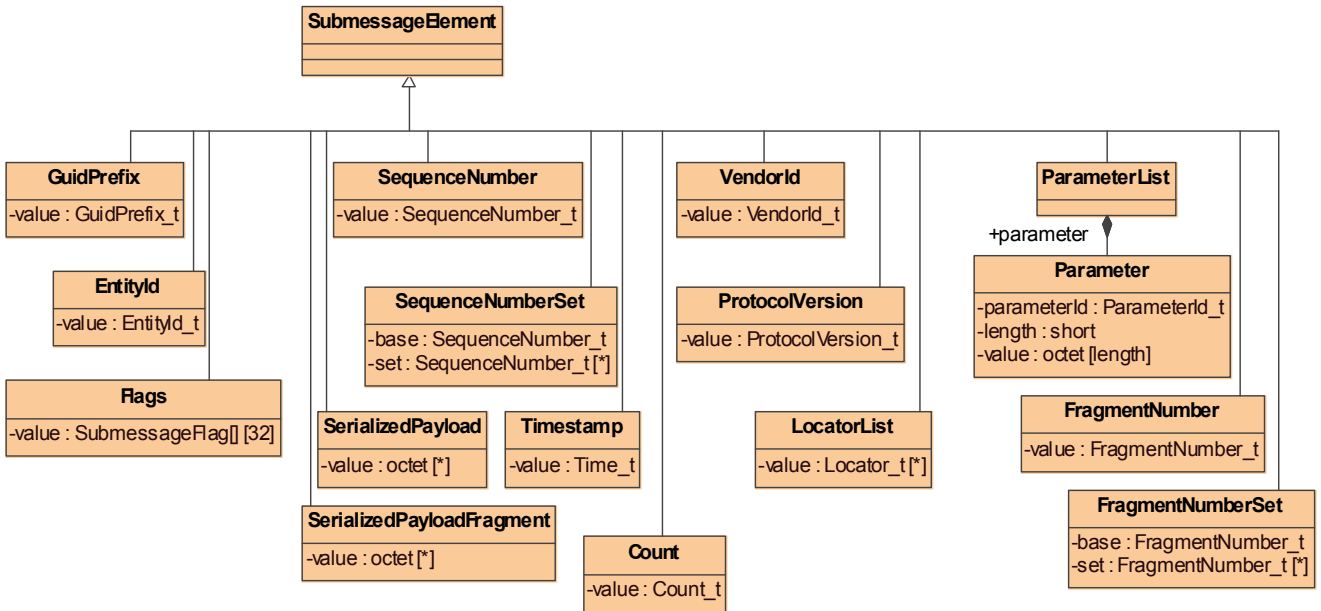

Figure 8.12 - RTPS SubmessageElements

8.3.5.1 The GuidPrefix, and EntityId

These SubmessageElements are used to encapsulate the **GuidPrefix_t** and **EntityId_t** parts of a **GUID_t** (defined in Section 8.2.4.1) within Submessages.

Table 8.17 - Structure of the GuidPrefix SubmessageElement

field	type	meaning
<i>value</i>	GuidPrefix_t	Identifies the GuidPrefix_t part of the GUID_t of the Entity that is the source or target of the message.

Table 8.18 - Structure of the EntityId SubmessageElement

field	type	meaning
<i>value</i>	EntityId_t	Identifies the EntityId_t part of the GUID_t of the Entity that is the source or target of the message.

8.3.5.2 VendorId

The VendorId identifies the vendor of the middleware implementing the RTPS protocol and allows this vendor to add specific extensions to the protocol. The vendor ID does not refer to the vendor of the device or product that contains DDS middleware.

Table 8.19 - Structure of the VendorId SubmessageElement

field	type	meaning
<i>value</i>	VendorId_t	Identifies the vendor of the middleware that implements the protocol.

The following values are reserved by the protocol:

VENDORID_UNKNOWN

Other values must be assigned by the OMG.

8.3.5.3 ProtocolVersion

The ProtocolVersion defines the version of the RTPS protocol.

Table 8.20 - Structure of the ProtocolVersion SubmessageElement

field	type	meaning
<i>value</i>	ProtocolVersion_t	Identifies the major and minor version of the RTPS protocol.

The RTPS protocol version 2.1 defines the following special values:

PROTOCOLVERSION_1_0
PROTOCOLVERSION_1_1
PROTOCOLVERSION_2_0
[PROTOCOLVERSION_2_1](#)
PROTOCOLVERSION

8.3.5.4 SequenceNumber

A sequence number is a 64-bit signed integer, that can take values in the range: $-2^{63} \leq N \leq 2^{63}-1$. The selection of 64 bits as the representation of a sequence number ensures the sequence numbers never¹ wrap. Sequence numbers begin at 1.

Table 8.21 - Structure of the SequenceNumber SubmessageElement

field	type	meaning
<i>value</i>	SequenceNumber_t	Provides the value of the 64-bit sequence number.

The protocol reserves the following value:

SEQUENCENUMBER_UNKNOWN

8.3.5.5 SequenceNumberSet

SequenceNumberSet SubmessageElements are used as parts of several messages to provide binary information about individual sequence numbers within a range. The sequence numbers represented in the **SequenceNumberSet** are limited to belong to an interval with a range no bigger than 256. In other words, a valid **SequenceNumberSet** must verify that:

```
maximum(SequenceNumberSet) - minimum(SequenceNumberSet) < 256  
minimum(SequenceNumberSet) >= 1
```

The above restriction allows **SequenceNumberSet** to be represented in an efficient and compact way using bitmaps.

SequenceNumberSet SubmessageElements are used for example to selectively request re-sending of a set of sequence numbers.

Table 8.22 - Structure of the SequenceNumberSet SubmessageElement

field	type	meaning
<i>base</i>	SequenceNumber_t	Identifies the first sequence number in the set.
<i>set</i>	SequenceNumber_t[*]	A set of sequence numbers, each verifying that: base <= element(set) <= base+255

1. Even assuming an extremely fast rate of message generation for a single RTPS Writer such as 100 messages per microsecond, the 64-bit integer would not roll over for approximately 3000 years of uninterrupted operation.

8.3.5.6 FragmentNumber

A fragment number is a 32-bit unsigned integer and is used by Submessages to identify a particular fragment in fragmented serialized data. Fragment numbers start at 1.

Table 8.23 - Structure of the FragmentNumber SubmessageElement

field	type	meaning
<i>value</i>	FragmentNumber_t	Provides the value of the 32-bit fragment number.

8.3.5.7 FragmentNumberSet

FragmentNumberSet SubmessageElements are used to provide binary information about individual fragment numbers within a range. The fragment numbers represented in the **FragmentNumberSet** are limited to belong to an interval with a range no bigger than 256. In other words, a valid **FragmentNumberSet** must verify that:

```
maximum(FragmentNumberSet) - minimum(FragmentNumberSet) < 256  
minimum(FragmentNumberSet) >= 1
```

The above restriction allows **FragmentNumberSet** to be represented in an efficient and compact way using bitmaps.

FragmentNumberSet SubmessageElements are used for example to selectively request re-sending of a set of fragments.

Table 8.24 - Structure of the FragmentNumberSet SubmessageElement

field	type	meaning
<i>base</i>	FragmentNumber_t	Identifies the first fragment number in the set.
<i>set</i>	FragmentNumber_t[*]	A set of fragment numbers, each verifying that: base <= element(set) <= base+255

8.3.5.8 Timestamp

Timestamp is used to represent time. The representation should be capable of having a resolution of nano-seconds or better.

Table 8.25 - Structure of the Timestamp SubmessageElement

field	type	meaning
<i>value</i>	Time_t	Provides the value of the timestamp

There are three special values used by the protocol:

```
TIME_ZERO  
TIME_INVALID  
TIME_INFINITE
```

8.3.5.9 ParameterList

ParameterList is used as part of several messages to encapsulate QoS parameters that may affect the interpretation of the message. The encapsulation of the parameters follows a mechanism that allows extensions to the QoS without breaking backwards compatibility.

Table 8.26 - Structure of the ParameterList SubmessageElement

field	type	meaning
<i>parameter</i>	Parameter[*]	List of parameters

Table 8.27 - Structure of each Parameter in a ParameterList SubmessageElement

field	type	meaning
<i>parameterId</i>	ParameterId_t	Uniquely identifies a parameter
<i>length</i>	short	Length of the parameter value
<i>value</i>	octet[length]	Parameter value

The actual representation of the ParameterList is defined for each PSM. However, in order to support inter-operability or bridging between PSMs and allow for extensions that preserve backwards compatibility, the representation used by all PSMs must comply with the following rules:

- There shall be no more than 2^{16} possible values of the ParameterId_t *parameterId*.
- A range of 2^{15} values is reserved for protocol-defined parameters. All the parameter_id values defined by the 2.1 version of the protocol and all future revisions of the same major version must use values in this range.
- A range of 2^{15} values is reserved for vendor-defined parameters. The 2.1 version of the protocol and any future revisions of the protocol that correspond to the same major version are not allowed to use values in this range.
- The maximum length of any parameter is limited to 2^{16} octets.

Subject to the above constraints, different PSMs might choose different representations for the ParameterId_t. For example a PSM could represent *parameterId* using short integers while another PSM may use strings.

8.3.5.10 KeyHashPrefix

~~KeyHashPrefix may be used (optional) by Data-Submessages to identify a particular data instance.~~

~~Table 8.28 - Structure of the KeyHashPrefix SubmessageElement~~

field	type	meaning
<i>value</i>	KeyHashPrefix_t	Prefix of instance identifier.

8.3.5.11 KeyHashSuffix

~~KeyHashSuffix is used by Data Submessages to identify a particular data instance.~~

~~Table 8.29 – Structure of the KeyHashSuffix SubmessageElement~~

field	type	meaning
value	KeyHashSuffix_t	Suffix of instance identifier.

8.3.5.12 Count

Count is used by several Submessages and enables a receiver to detect duplicates of the same Submessage.

Table 8.30 - Structure of the Count SubmessageElement

field	type	meaning
value	Count_t	Count value

8.3.5.13 LocatorList

LocatorList is used to specify a list of locators.

Table 8.31 - Structure of the LocatorList SubmessageElement

field	type	meaning
value	Locator_t[*]	List of locators

8.3.5.14 SerializedData

SerializedData contains the serialized representation of the value of a data-object. The RTPS protocol does not interpret the serialized data-stream. Therefore, it is represented as opaque data. For additional information on data encapsulation, see Chapter 10.

Table 8.32 - Structure of the SerializedData SubmessageElement

field	type	meaning
value	octet[*]	Serialized data-stream

8.3.5.15 SerializedDataFragment

SerializedDataFragment contains the serialized representation of a data-object that has been fragmented. Like for unfragmented SerializedData, the RTPS protocol does not interpret the fragmented serialized data-stream. Therefore, it is represented as opaque data. For additional information on data encapsulation, see Chapter 10.

Table 0.1

field	type	meaning
<i>value</i>	octet[*]	Serialized data-stream fragment

8.3.5.16 StatusInfo

~~StatusInfo contains a collection of flags. The interpretation of each flag depends on the Submessage and is described as part of the Submessage definition.~~

Table 8.33 ~~Structure of the StatusInfo SubmessageElement~~

field	type	meaning
<i>value</i>	SubmessageFlag[32]	A collection of flags. The interpretation of each flag depends on the Submessage.

8.3.6 The RTPS Header

As described in Section 8.3.3, every RTPS Message must start with a **Header**.

8.3.6.1 Purpose

The Header is used to identify the message as belonging to the RTPS protocol, to identify the version of the RTPS protocol used, and to provide context information that applies to the Submessages contained within the message.

8.3.6.2 Content

The elements that form the structure of the Header were described in Section 8.3.3.1. The structure of the Header can only be changed if the major version of the protocol is also changed.

8.3.6.3 Validity

A **Header** is invalid when any of the following are true:

- The Message has less than the required number of octets to contain a full **Header**. The number required is defined by the PSM.
- Its *protocol* value does not match the value of `PROTOCOL_RTPS`².
- The major protocol version is larger than the major protocol version supported by the implementation.

2. The actual value of the `PROTOCOL_RTPS` constant is provided by the PSM.

8.3.6.4 Change in state of Receiver

The initial state of the Receiver is described in Section 8.3.4. This section describes how the Header of a new Message affects the state of the Receiver.

```
Receiver.sourceGuidPrefix = Header.guidPrefix
Receiver.sourceVersion    = Header.version
Receiver.sourceVendorId  = Header.vendorId
Receiver.haveTimestamp    = false
```

8.3.6.5 Logical Interpretation

None

8.3.7 RTPS Submessages

The RTPS protocol version 2.1 defines several kinds of Submessages. They are categorized into two groups: Entity-Submessages and Interpreter-Submessages. Entity Submessages target an RTPS *Entity*. Interpreter Submessages modify the RTPS *Receiver* state and provide context that helps process subsequent Entity Submessages.

The Entity Submessages are:

- **Data**: Contains information regarding the value of an application Data-object. **Data** Submessages are sent by **Writers** (**NO_KEY Writer** or **WITH_KEY Writer**) to **Readers** (**NO_KEY Reader** or **WITH_KEY Reader**).
- **DataFrag**: Equivalent to **Data**, but only contains a part of the new value (one or more fragments). Allows data to be transmitted as multiple fragments to overcome transport message size limitations.
- ~~**NoKeyData**: Contains information regarding the value of an application Data-object. **NoKeyData** Submessages are sent by a **NO_KEY Writer** to **NO_KEY Reader** endpoints.~~
- ~~**Data**: Contains information regarding the value of an application Data-object. **Data** Submessages are sent by **WITH_KEY Writers** to **WITH_KEY Readers**.~~
- ~~**NoKeyDataFrag**: Equivalent to **NoKeyData**, but only contains a part of the new value (one or more fragments). Allows data to be transmitted as multiple fragments to overcome transport message size limitations.~~
- ~~**DataFrag**: Equivalent to **Data**, but only contains a part of the new value (one or more fragments). Allows data to be transmitted as multiple fragments to overcome transport message size limitations.~~
- **Heartbeat**: Describes the information that is available in a **Writer**. **Heartbeat** messages are sent by a **Writer** (**NO_KEY Writer** or **WITH_KEY Writer**) to one or more **Readers** (**NO_KEY Reader** or **WITH_KEY Reader**).
- **HeartbeatFrag**: For fragmented data, describes what fragments are available in a **Writer**. **HeartbeatFrag** messages are sent by a **Writer** (**NO_KEY Writer** or **WITH_KEY Writer**) to one or more **Readers** (**NO_KEY Reader** or **WITH_KEY Reader**).
- **Gap**: Describes the information that is no longer relevant to **Readers**. **Gap** messages are sent by a **Writer** to one or more **Readers**.
- **AckNack**: Provides information on the state of a **Reader** to a **Writer**. **AckNack** messages are sent by a **Reader** to one or more **Writers**.
- **NackFrag**: Provides information on the state of a **Reader** to a **Writer**, more specifically what fragments the **Reader** is still missing. **NackFrag** messages are sent by a **Reader** to one or more **Writers**.

The Interpreter Submessages are:

- **InfoSource**. Provides information about the source from which subsequent Entity Submessages originated. This Submessage is primarily used for relaying RTPS Submessages. This is not discussed in the current specification.
- **InfoDestination** Provides information about the final destination of subsequent Entity Submessages. This Submessage is primarily used for relaying RTPS Submessages. This is not discussed in the current specification.
- **InfoReply** Provides information about where to reply to the entities that appear in subsequent Submessages.
- **InfoTimestamp**. Provides a source timestamp for subsequent Entity Submessages.
- **Pad**. Used to add padding to a Message if needed for memory alignment.

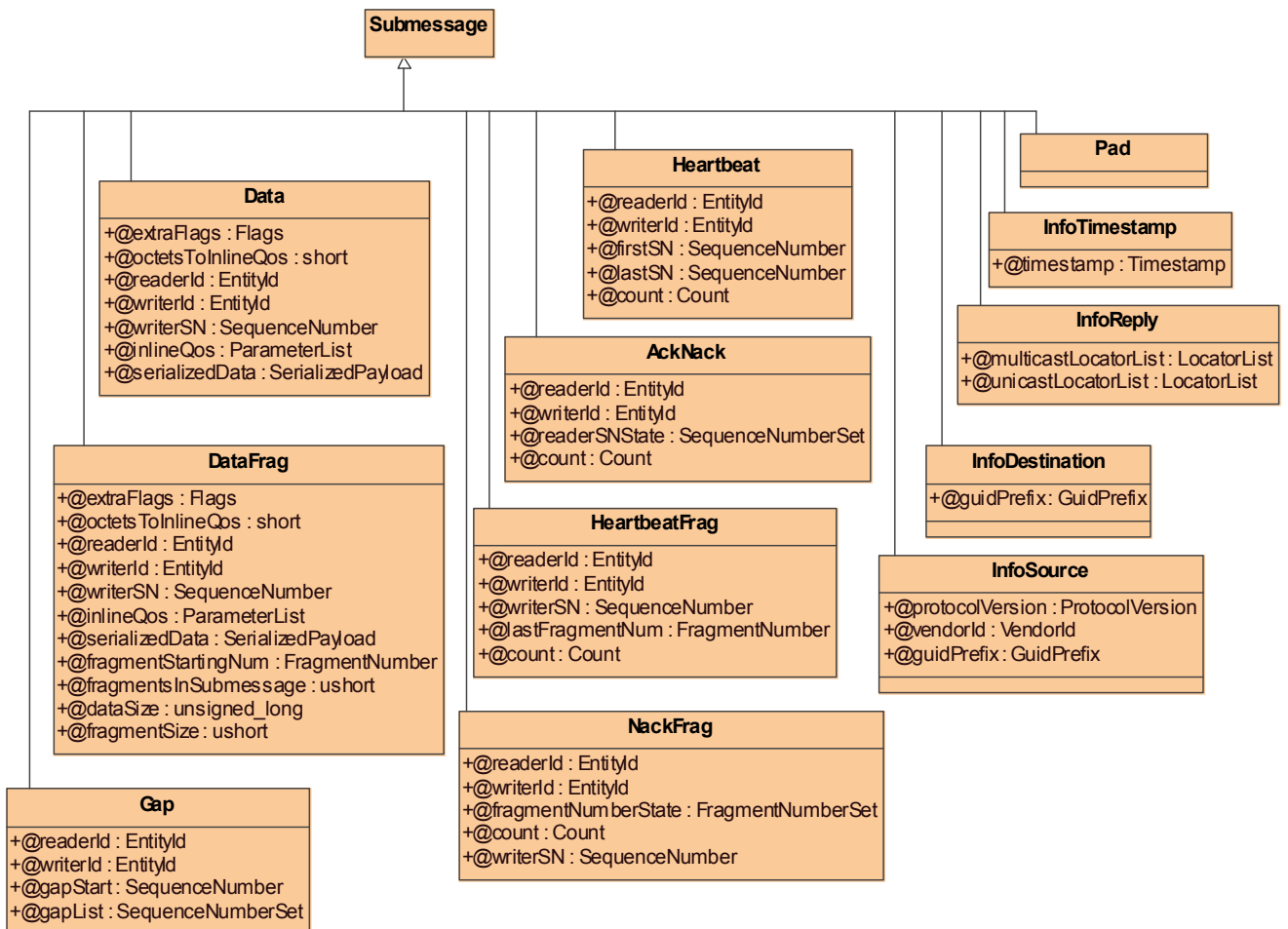

Figure 8.13 - RTPS Submessages

This section describes each of the Submessages and their interpretation. Each Submessage is described in the same manner under the headings described in Table 8.31.

Table 8.34 - Scheme used to describe each Submessage

heading	meaning
Purpose	High-level description of the main purpose of the Submessage
Content	Description of the SubmessageHeader (<i>SubmessageId</i> and <i>flags</i>). Description of the SubmessageElements that can appear in the Submessage .
Validity	Constraints that must be met by the Submessage in order for it to be valid.
Change in State of the Receiver	The interpretation and meaning of a Submessage within a Message may depend on the previous Submessages within that same Message . As described in Section 8.3.4 this context is modeled as the state of a Receiver object.
Logical interpretation	Description of how the Submessage should be interpreted

8.3.7.1 AckNack

8.3.7.1.1 Purpose

This Submessage is used to communicate the state of a **Reader** to a **Writer**. The Submessage allows the Reader to inform the Writer about the sequence numbers it has received and which ones it is still missing. This Submessage can be used to do both positive and negative acknowledgments.

8.3.7.1.2 Content

The elements that form the structure of the **AckNack** message are described in the table below.

Table 8.35 - Structure of the AckNack Submessage

element	type	meaning
<i>EndiannessFlag</i>	SubmessageFlag	Appears in the Submessage header flags. Indicates endianness.
<i>FinalFlag</i>	SubmessageFlag	Appears in the Submessage header flags. Indicates to the Writer whether a response is mandatory.
<i>readerId</i>	EntityId	Identifies the Reader entity that acknowledges receipt of certain sequence numbers and/or requests to receive certain sequence numbers.
<i>writerId</i>	EntityId	Identifies the Writer entity that is the target of the AckNack message. This is the Writer Entity that is being asked to re-send some sequence numbers or is being informed of the reception of certain sequence numbers.

Table 8.35 - Structure of the AckNack Submessage

element	type	meaning
<i>readerSNState</i>	SequenceNumberSet	Communicates the state of the reader to the writer. All sequence numbers up to the one prior to <i>readerSNState.base</i> are confirmed as received by the reader. The sequence numbers that appear in the set indicate missing sequence numbers on the reader side. The ones that do not appear in the set are undetermined (could be received or not).
<i>count</i>	Count	A counter that is incremented each time a new AckNack message is sent. Provides the means for a Writer to detect duplicate AckNack messages that can result from the presence of redundant communication paths.

8.3.7.1.3 Validity

This Submessage is *invalid* when any of the following is true:

- *submessageLength* in the Submessage header is too small.
- *readerSNState* is invalid (as defined in Section 8.3.5.5).

8.3.7.1.4 Change in state of Receiver

None

8.3.7.1.5 Logical Interpretation

The **Reader** sends the **AckNack** message to the **Writer** to communicate its state with respect to the sequence numbers used by the **Writer**.

The Writer is uniquely identified by its GUID. The Writer GUID is obtained using the state of the Receiver:

```
writerGUID = { Receiver.destGuidPrefix, AckNack.writerId }
```

The Reader is uniquely identified by its GUID. The Reader GUID is obtained using the state of the Receiver:

```
readerGUID = { Receiver.sourceGuidPrefix, AckNack.readerId }
```

The message serves two purposes simultaneously:

- The Submessage *acknowledges* all sequence numbers up to and including the one just before the lowest sequence number in the SequenceNumberSet (that is *readerSNState.base - 1*).
- The Submessage *negatively-acknowledges* (requests) the sequence numbers that appear explicitly in the set.

The mechanism to explicitly represent sequence numbers depends on the PSM. Typically, a compact representation (such as a bitmap) is used.

The *FinalFlag* indicates whether a response by the **Writer** is expected by the **Reader** or if the decision is left to the **Writer**. The use of this flag is described in Section 8.4.

8.3.7.2 Data

This Submessage is sent from an RTPS *Writer* with ~~topic_kind~~=(NO_KEY or WITH_KEY) to an RTPS *Reader* with ~~topic_kind~~=(NO_KEY or WITH_KEY).

8.3.7.2.1 Purpose

The Submessage notifies the RTPS *Reader* of a change to a data-object belonging to the RTPS *Writer*. The possible changes include both changes in value as well as changes to the lifecycle of the data-object.

8.3.7.2.2 Contents

The elements that form the structure of the **Data** message are described in the table below.

Table 8.36 - Structure of the Data Submessage

element	type	meaning
<i>EndiannessFlag</i>	SubmessageFlag	Appears in the Submessage header flags. Indicates endianness.
<i>InlineQosFlag</i>	SubmessageFlag	Appears in the Submessage header flags. Indicates to the Reader the presence of a ParameterList containing QoS parameters that should be used to interpret the message.
<i>StatusInfoFlag</i>	SubmessageFlag	Appears in the Submessage header flags. Indicates to the Reader the presence of a StatusInfo-SubmessageElement. The status info provides information on the status of the data-object, such a change in its life-cycle-state.
<i>DataFlag</i>	SubmessageFlag	Appears in the Submessage header flags. Indicates to the Reader the presence of serialized data that updates the value of the data-object. <u>Appears in the Submessage header flags.</u> <u>Indicates to the Reader that the dataPayload submessage element contains the serialized value of the data-object.</u>
<u><i>KeyFlag</i></u>	<u>SubmessageFlag</u>	<u>Appears in the Submessage header flags.</u> <u>Indicates to the Reader that the dataPayload submessage element contains the serialized value of the key of the data-object.</u>
<i>KeyHashFlag</i>	SubmessageFlag	Appears in the Submessage header flags. Indicates to the Reader the presence of a keyHashPrefix-Submessage element.
<i>readerId</i>	EntityId	Identifies the RTPS <i>Reader</i> entity that is being informed of the change to the data-object.

Table 8.36 - Structure of the Data Submessage

element	type	meaning
<i>writerId</i>	EntityId	Identifies the RTPS <i>Writer</i> entity that made the change to the data-object.
<i>keyHashPrefix</i>	KeyHashPrefix	Provide a hint for the key that uniquely identifies the data-object that is being changed within the set of objects that have been registered by the RTPS <i>Writer</i>.
<i>keyHashSuffix</i>	KeyHashSuffix	
<i>writerSN</i>	SequenceNumber	Uniquely identifies the change and the relative order for all changes made by the RTPS <i>Writer</i> identified by the writerGuid. Each change gets a consecutive sequence number. Each RTPS <i>Writer</i> maintains its own sequence number.
<i>statusInfo</i>	StatusInfo	Present only if the StatusInfoFlag is set in the header. The StatusInfo SubmessageElement contains status information on the Data Object to which the message applies, such as its LifecycleState. It contains the following flags: <i>DisposedFlag</i> and <i>UnregisteredFlag</i>. The <i>DisposedFlag</i> indicates to the Reader whether the data-object has been disposed by the Writer (i.e. the Writer indicates it no longer exists). The <i>UnregisteredFlag</i> indicates to the Reader whether the data-object has been unregistered by the Writer (i.e. the Writer will not provide any further updates on the data-object).
<i>inlineQos</i>	ParameterList	Present only if the InlineQosFlag is set in the header. Contains QoS that may affect the interpretation of the message.
<i>serializedDataPayload</i>	SerializedDataPayload	Present only if DataFlag is set in the header. Encapsulation of the new value of the data-object after the change. <u>Present only if either the DataFlag or the KeyFlag are set in the header.</u> <u>If the DataFlag is set, then it contains the encapsulation of the new value of the data-object after the change.</u> <u>If the KeyFlag is set, then it contains the encapsulation of the key of the data-object the message refers to.</u>

8.3.7.2.3 Validity

This Submessage is *invalid* when any of the following is true:

- *submessageLength* in the Submessage header is too small.
- *writerSN.value* is not strictly positive (1, 2, ...) or is **SEQUENCENUMBER_UNKNOWN**.
- *inlineQos* is invalid.

8.3.7.2.4 Change in state of Receiver

None

8.3.7.2.5 Logical Interpretation

The RTPS *Writer* sends the **Data** Submessage to the RTPS *Reader* to communicate changes to the data-objects within the writer. Changes include both changes in value as well as changes to the lifecycle of the data-object.

~~Changes to the lifecycle are communicated using the StatusInfo SubmessageElement, which contains the *DisposedFlag* and the *UnregisteredFlag*. The settings of the *DisposedFlag* and *UnregisteredFlag* indicate whether the corresponding data-object has been disposed or unregistered (or both) by the writer.~~

Changes to the value are communicated by the presence of the *serializedPayload*. When present, the *serializedPayload* is interpreted either as the value of the data-object or as the key that uniquely identifies the data-object from the set of registered objects:

- If the *DataFlag* is set and the *KeyFlag* is not set, the *serializedPayload* element is interpreted as the value of the data-object.
- If the *KeyFlag* is set and the *DataFlag* is not set, the *serializedPayload* element is interpreted as the value of the key that identifies the registered instance of the data-object.

~~Changes to the value are communicated by the presence of the *serializedData*. This element is only present if the *DataFlag* is set.~~

If the *InlineQosFlag* is set, the *inlineQos* element contains QoS values that override those of the RTPS *Writer* and should be used to process the update. For a complete list of possible in-line QoS parameters, see Table 8.79.

~~If the *KeyHashFlag* is set, the *keyHashPrefix* element contains a valid prefix. In that case, the instance is uniquely identified using:~~

~~instanceGUID = { Data.keyHashPrefix, Data.keyHashSuffix }~~

~~If no *keyHashPrefix* element is sent with the data, the prefix is obtained using the state of the Receiver:~~

~~instanceGUID = { Receiver.sourceGuidPrefix, Data.keyHashSuffix }~~

The Writer is uniquely identified by its GUID. The Writer GUID is obtained using the state of the Receiver:

writerGUID = { Receiver.sourceGuidPrefix, Data.writerId }

The Reader is uniquely identified by its GUID. The Reader GUID is obtained using the state of the Receiver:

readerGUID = { Receiver.destGuidPrefix, Data.readerId }

The Data.readerId can be ENTITYID_UNKNOWN, in which case the **Data** applies to all *Readers* of that *writerGUID* within the *Participant* identified by the *GuidPrefix_t* Receiver.destGuidPrefix.

8.3.7.3 DataFrag

This Submessage is sent from an RTPS *Writer* ~~with *topic_kind*==**WITH_KEY**(**NO_KEY** or **WITH_KEY**)~~ to an RTPS *Reader* ~~with *topic_kind*==**WITH_KEY**(**NO_KEY** or **WITH_KEY**)~~.

8.3.7.3.1 Purpose

The **DataFrag** Submessage extends the **Data** Submessage by enabling the *serializedData* to be fragmented and sent as multiple **DataFrag** Submessages. The fragments contained in the **DataFrag** Submessages are then re-assembled by the RTPS **Reader**.

Defining a separate **DataFrag** Submessage in addition to the **Data** Submessage, offers the following advantages:

- It keeps variations in contents and structure of each Submessage to a minimum. This enables more efficient implementations of the protocol as the parsing of network packets is simplified.
- It avoids having to add fragmentation information as in-line QoS parameters in the **Data** Submessage. This may not only slow down performance, it also makes on-the-wire debugging more difficult, as it is no longer obvious whether data is fragmented or not and which message contains what fragment(s).

8.3.7.3.2 Contents

The elements that form the structure of the **DataFrag** Submessage are described in the table below.

Table 8.37 - Structure of the DataFrag Submessage

element	type	meaning
<i>EndiannessFlag</i>	SubmessageFlag	Appears in the Submessage header flags. Indicates endianness.
<i>InlineQosFlag</i>	SubmessageFlag	Appears in the Submessage header flags. Indicates to the Reader the presence of a ParameterList containing QoS parameters that should be used to interpret the message.
<i>KeyHashFlag</i>	SubmessageFlag	Appears in the Submessage header flags. Indicates to the Reader the presence of a keyHashPrefix-Submessage element.
<i>readerId</i>	EntityId	Identifies the RTPS Reader entity that is being informed of the change to the data-object.
<i>writerId</i>	EntityId	Identifies the RTPS Writer entity that made the change to the data-object.
<i>keyHashPrefix</i>	KeyHashPrefix	Provide a hint for the key that uniquely identifies the data-object that is being changed within the set of objects that have been registered by the RTPS Writer.
<i>keyHashSuffix</i>	KeyHashSuffix	
<i>writerSN</i>	SequenceNumber	Uniquely identifies the change and the relative order for all changes made by the RTPS Writer identified by the writerGuid. Each change gets a consecutive sequence number. Each RTPS Writer maintains its own sequence number.
<i>fragmentStartingNum</i>	FragmentNumber	Indicates the starting fragment for the series of fragments in <i>serializedData</i> . Fragment numbering starts with number 1.

Table 8.37 - Structure of the DataFrag Submessage

element	type	meaning
<i>fragmentsInSubmessage</i>	ushort	The number of consecutive fragments contained in this Submessage, starting at <i>fragmentStartingNum</i> .
<i>dataSize</i>	ulong	The total size in bytes of the original data before fragmentation.
<i>fragmentSize</i>	ushort	The size of an individual fragment in bytes. The maximum fragment size equals 64K.
<i>inlineQos</i>	ParameterList	Present only if the InlineQosFlag is set in the header. Contains QoS that may affect the interpretation of the message.
<i>serializedPayloadData</i>	SerializedDataPayload	<p>Present only if DataFlag is set in the header. Encapsulation of a consecutive series of fragments, starting at <i>fragmentStartingNum</i> for a total of <i>fragmentsInSubmessage</i>. Represents part of the new value of the data-object after the change.</p> <p><u>Present only if either the DataFlag or the KeyFlag are set in the header.</u></p> <ul style="list-style-type: none"> <u>If the DataFlag is set, then it contains a consecutive set of fragments of the encapsulation of the new value of the data-object after the change.</u> <u>If the KeyFlag is set, then it contains a consecutive set of fragments of the encapsulation of the key of the data-object the message refers to.</u> <p><u>In either case the consecutive set of fragments contains <i>fragmentsInSubmessage</i> fragments and starts with the fragment identified by <i>fragmentStartingNum</i>.</u></p>

8.3.7.3.3 Validity

This Submessage is *invalid* when any of the following is true:

- *submessageLength* in the Submessage header is too small.
- *writerSN.value* is not strictly positive (1, 2, ...) or is **SEQUENCENUMBER_UNKNOWN**.
- *fragmentStartingNum.value* is not strictly positive (1, 2, ...) or exceeds the total number of fragments (see below).
- *fragmentSize* exceeds *dataSize*.
- The size of *serializedData* exceeds *fragmentsInSubmessage* * *fragmentSize*.
- *inlineQos* is invalid.

8.3.7.3.4 Change in state of Receiver

None

8.3.7.3.5 Logical Interpretation

The **DataFrag** Submessage extends the **Data** Submessage by enabling the *serializedData* to be fragmented and sent as multiple **DataFrag** Submessages. Once the *serializedData* is re-assembled by the RTPS **Reader**, the interpretation of the **DataFrag** Submessages is identical to that of the **Data** Submessage.

How to re-assemble *serializedData* using the information in the **DataFrag** Submessage is described below.

The total size of the data to be re-assembled is given by *dataSize*. Each **DataFrag** Submessage contains a contiguous segment of this data in its *serializedData* element. The size of the segment is determined by the size of the *serializedData* element. During re-assembly, the offset of each segment is determined by:

$$(\text{fragmentStartingNum} - 1) * \text{fragmentSize}$$

The data is fully re-assembled when all fragments have been received. The total number of fragments to expect equals:

$$\text{dataSize} / \text{fragmentSize} + (\text{dataSize} \% \text{fragmentSize}) ? 1 : 0$$

Note that each **DataFrag** Submessage may contain multiple fragments. An RTPS **Writer** will select *fragmentSize* based on the smallest message size supported across all underlying transports. If some RTPS **Readers** can be reached across a transport that supports larger messages, the RTPS **Writer** can pack multiple fragments into a single **DataFrag** Submessage or may even send a regular **Data** Submessage if fragmentation is no longer required. For more details, see Section 8.4.14.1.

8.3.7.4 Gap

8.3.7.4.1 Purpose

This Submessage is sent from an RTPS **Writer** to an RTPS **Reader** and indicates to the RTPS **Reader** that a range of sequence numbers is no longer relevant. The set may be a contiguous range of sequence numbers or a specific set of sequence numbers.

8.3.7.4.2 Content

The elements that form the structure of the **Gap** message are described in the table below.

Table 8.38 - Structure of the Gap Submessage

element	type	meaning
<i>EndiannessFlag</i>	SubmessageFlag	Appears in the Submessage header flags. Indicates endianness.
<i>readerId</i>	EntityId	Identifies the Reader Entity that is being informed of the irrelevance of a set of sequence numbers.
<i>writerId</i>	EntityId	Identifies the Writer Entity to which the range of sequence numbers applies.
<i>gapStart</i>	SequenceNumber	Identifies the first sequence number in the interval of irrelevant sequence numbers.

Table 8.38 - Structure of the Gap Submessage

element	type	meaning
<i>gapList</i>	SequenceNumberSet	Serves two purposes: (1) Identifies the last sequence number in the interval of irrelevant sequence numbers. (2) Identifies an additional list of sequence numbers that are irrelevant.

8.3.7.4.3 Validity

This Submessage is *invalid* when any of the following is true:

- *submessageLength* in the Submessage header is too small.
- *gapStart* is zero or negative.
- *gapList* is invalid (as defined in Section 8.3.5.5).

8.3.7.4.4 Change in state of Receiver

None

8.3.7.4.5 Logical Interpretation

The RTPS *Writer* sends the **Gap** message to the RTPS *Reader* to communicate that certain sequence numbers are no longer relevant. This is typically caused by Writer-side filtering of the sample (content-filtered topics, time-based filtering). In this scenario, new data-values may replace the old values of the data-objects that were represented by the sequence numbers that appear as irrelevant in the **Gap**.

The irrelevant sequence numbers communicated by the **Gap** message are composed of two groups:

- All sequence numbers in the range $gapStart \leq sequence_number \leq gapList.base - 1$
- All the sequence numbers that appear explicitly listed in the *gapList*.

This set will be referred to as the **Gap::irrelevant_sequence_number_list**.

The Writer is uniquely identified by its GUID. The Writer GUID is obtained using the state of the Receiver:

```
writerGUID = { Receiver.sourceGuidPrefix, Gap.writerId }
```

The Reader is uniquely identified by its GUID. The Reader GUID is obtained using the state of the Receiver:

```
readerGUID = { Receiver.destGuidPrefix, Gap.readerId }
```

8.3.7.5 Heartbeat

8.3.7.5.1 Purpose

This message is sent from an RTPS *Writer* to an RTPS *Reader* to communicate the sequence numbers of changes that the **Writer** has available.

8.3.7.5.2 Content

The elements that form the structure of the **Heartbeat** message are described in the table below.

Table 8.39 - Structure of the Heartbeat Submessage

element	type	meaning
<i>EndiannessFlag</i>	SubmessageFlag	Appears in the Submessage header flags. Indicates endianness.
<i>FinalFlag</i>	SubmessageFlag	Appears in the Submessage header flags. Indicates whether the Reader is required to respond to the Heartbeat or if it is just an advisory heartbeat.
<i>LivelinessFlag</i>	SubmessageFlag	Appears in the Submessage header flags. Indicates that the DDS DataWriter associated with the RTPS Writer of the message has manually asserted its LIVENESS.
<i>readerId</i>	EntityId	Identifies the Reader Entity that is being informed of the availability of a set of sequence numbers. Can be set to ENTITYID_UNKNOWN to indicate all readers for the writer that sent the message.
<i>writerId</i>	EntityId	Identifies the Writer Entity to which the range of sequence numbers applies.
<i>firstSN</i>	SequenceNumber	Identifies the first (lowest) sequence number that is available in the Writer.
<i>lastSN</i>	SequenceNumber	Identifies the last (highest) sequence number that is available in the Writer.
<i>count</i>	Count	A counter that is incremented each time a new Heartbeat message is sent. Provides the means for a Reader to detect duplicate Heartbeat messages that can result from the presence of redundant communication paths.

8.3.7.5.3 Validity

This Submessage is *invalid* when any of the following is true:

- *submessageLength* in the Submessage header is too small
- *firstSN.value* is zero or negative
- *lastSN.value* is zero or negative
- *lastSN.value* < *firstSN.value*

8.3.7.5.4 Change in state of Receiver

None

8.3.7.5.5 Logical Interpretation

The **Heartbeat** message serves two purposes:

- It informs the **Reader** of the sequence numbers that are available in the writer's **HistoryCache** so that the **Reader** may request (using an **AckNack**) any that it has missed.
- It requests the **Reader** to send an acknowledgement for the **CacheChange** changes that have been entered into the reader's **HistoryCache** such that the **Writer** knows the state of the reader.

All **Heartbeat** messages serve the first purpose. That is, the Reader will always find out the state of the writer's **HistoryCache** and may request what it has missed. Normally, the RTPS **Reader** would only send an **AckNack** message if it is missing a **CacheChange**.

The **Writer** uses the **FinalFlag** to request the **Reader** to send an acknowledgment for the sequence numbers it has received. If the **Heartbeat** has the **FinalFlag** set, then the **Reader** is **not** required to send an **AckNack** message back. However, if the **FinalFlag** is not set, then the **Reader must** send an **AckNack** message indicating which **CacheChange** changes it has received, even if the **AckNack** indicates it has received all **CacheChange** changes in the writer's **HistoryCache**.

The **Writer** sets the **LivelinessFlag** to indicate that the DDS DataWriter associated with the RTPS **Writer** of the message has manually asserted its liveliness using the appropriate DDS operation (see the DDS Specification). The RTPS **Reader** should therefore renew the manual liveliness lease of the corresponding remote DDS DataWriter.

The **Writer** is uniquely identified by its GUID. The Writer GUID is obtained using the state of the Receiver:

```
writerGUID = { Receiver.sourceGuidPrefix, Heartbeat.writerId }
```

The **Reader** is uniquely identified by its GUID. The Reader GUID is obtained using the state of the Receiver:

```
readerGUID = { Receiver.destGuidPrefix, Heartbeat.readerId }
```

The `Heartbeat.readerId` can be `ENTITYID_UNKNOWN`, in which case the **Heartbeat** applies to all **Readers** of that `writerGUID` within the **Participant**.

8.3.7.6 HeartbeatFrag

8.3.7.6.1 Purpose

When fragmenting data and until all fragments are available, the **HeartbeatFrag** Submessage is sent from an RTPS **Writer** to an RTPS **Reader** to communicate which fragments the **Writer** has available. This enables reliable communication at the fragment level.

Once all fragments are available, a regular **Heartbeat** message is used.

8.3.7.6.2 Content

The elements that form the structure of the **HeartbeatFrag** message are described in the table below.

Table 8.40 - Structure of the HeartbeatFrag Submessage

element	type	meaning
<i>EndiannessFlag</i>	SubmessageFlag	Appears in the Submessage header flags. Indicates endianness.
<i>readerId</i>	EntityId	Identifies the Reader Entity that is being informed of the availability of fragments. Can be set to ENTITYID_UNKNOWN to indicate all readers for the writer that sent the message.
<i>writerId</i>	EntityId	Identifies the Writer Entity that sent the Submessage.
<i>writerSN</i>	SequenceNumber	Identifies the sequence number of the data change for which fragments are available.
<i>lastFragmentNum</i>	FragmentNumber	All fragments up to and including this last (highest) fragment are available on the Writer for the change identified by <i>writerSN</i> .
<i>count</i>	Count	A counter that is incremented each time a new HeartbeatFrag message is sent. Provides the means for a Reader to detect duplicate HeartbeatFrag messages that can result from the presence of redundant communication paths.

8.3.7.6.3 Validity

This Submessage is *invalid* when any of the following is true:

- *submessageLength* in the Submessage header is too small
- *writerSN.value* is zero or negative
- *lastFragmentNum.value* is zero or negative

8.3.7.6.4 Change in state of Receiver

None

8.3.7.6.5 Logical Interpretation

The **HeartbeatFrag** message serves the same purpose as a regular **Heartbeat** message, but instead of indicating the availability of a range of sequence numbers, it indicates the availability of a range of fragments for the data change with sequence number *WriterSN*.

The RTPS **Reader** will respond by sending a **NackFrag** message, but only if it is missing any of the available fragments.

The **Writer** is uniquely identified by its GUID. The Writer GUID is obtained using the state of the Receiver:

```
writerGUID = { Receiver.sourceGuidPrefix, Heartbeat.writerId }
```

The **Reader** is uniquely identified by its GUID. The Reader GUID is obtained using the state of the Receiver:

```
readerGUID = { Receiver.destGuidPrefix, Heartbeat.readerId }
```

The HeartbeatFrag.readerId can be ENTITYID_UNKNOWN, in which case the **HeartbeatFrag** applies to all **Readers** of that Writer GUID within the **Participant**.

8.3.7.7 InfoDestination

8.3.7.7.1 Purpose

This message is sent from an RTPS **Writer** to an RTPS **Reader** to modify the GuidPrefix used to interpret the **Reader** entityIds appearing in the Submessages that follow it.

8.3.7.7.2 Content

The elements that form the structure of the **InfoDestination** message are described in the table below.

Table 8.41 - Structure of the InfoDestination Submessage

element	type	meaning
<i>EndiannessFlag</i>	SubmessageFlag	Appears in the Submessage header flags. Indicates endianness.
<i>guidPrefix</i>	GuidPrefix	Provides the GuidPrefix that should be used to reconstruct the GUIDs of all the RTPS Reader entities whose EntityIds appears in the Submessages that follow.

8.3.7.7.3 Validity

This Submessage is *invalid* when any of the following is true:

- *submessageLength* in the Submessage header is too small.

8.3.7.7.4 Change in state of Receiver

```
if (InfoDestination.guidPrefix != GUIDPREFIX_UNKNOWN) {
    Receiver.destGuidPrefix = InfoDestination.guidPrefix
} else {
    Receiver.destGuidPrefix = <GuidPrefix_t of the Participant receiving the message>
}
```

8.3.7.7.5 Logical Interpretation

None

8.3.7.8 InfoReply

8.3.7.8.1 Purpose

This message is sent from an RTPS **Reader** to an RTPS **Writer**. It contains explicit information on where to send a reply to the Submessages that follow it within the same message.

8.3.7.8.2 Content

The elements that form the structure of the **InfoReply** message are described in the table below.

Table 8.42 - Structure of the InfoReply Submessage

element	type	meaning
<i>EndiannessFlag</i>	SubmessageFlag	Appears in the Submessage header flags. Indicates endianness.
<i>MulticastFlag</i>	SubmessageFlag	Appears in the Submessage header flags. Indicates whether the Submessage also contains a multicast address.
<i>unicastLocatorList</i>	LocatorList	Indicates an alternative set of unicast addresses that the Writer should use to reach the Readers when replying to the Submessages that follow.
<i>multicastLocatorList</i>	LocatorList	Indicates an alternative set of multicast addresses that the Writer should use to reach the Readers when replying to the Submessages that follow. Only present when the <i>MulticastFlag</i> is set.

8.3.7.8.3 Validity

This Submessage is *invalid* when any of the following is true:

- *submessageLength* in the Submessage header is too small.

8.3.7.8.4 Change in state of Receiver

```
Receiver.unicastReplyLocatorList = InfoReply.unicastLocatorList

if ( MulticastFlag ) {
    Receiver.multicastReplyLocatorList = InfoReply.multicastLocatorList
} else {
    Receiver.multicastReplyLocatorList = <empty>
}
```

8.3.7.8.5 Logical Interpretation

None

8.3.7.9 InfoSource

8.3.7.9.1 Purpose

This message modifies the logical source of the Submessages that follow.

8.3.7.9.2 Content

The elements that form the structure of the **InfoSource** message are described in the table below.

Table 8.43 - Structure of the InfoSource Submessage

element	type	meaning
<i>EndiannessFlag</i>	SubmessageFlag	Appears in the Submessage header flags. Indicates endianness.
<i>protocolVersion</i>	ProtocolVersion	Indicates the protocol used to encapsulate subsequent Submessages.
<i>vendorId</i>	VendorId	Indicates the VendorId of the vendor that encapsulated subsequent Submessages.
<i>guidPrefix</i>	GuidPrefix	Identifies the Participant that is the container of the RTPS Writer entities that are the source of the Submessages that follow.

8.3.7.9.3 Validity

This Submessage is *invalid* when any of the following is true:

- *submessageLength* in the Submessage header is too small.

8.3.7.9.4 Change in state of Receiver

```
Receiver.sourceGuidPrefix = InfoSource.guidPrefix
Receiver.sourceVersion = InfoSource.protocolVersion
Receiver.sourceVendorId = InfoSource.vendorId
Receiver.unicastReplyLocatorList = { LOCATOR_INVALID }
Receiver.multicastReplyLocatorList = { LOCATOR_INVALID }
haveTimestamp = false
```

8.3.7.9.5 Logical Interpretation

None

8.3.7.9.6 InfoTimestamp

8.3.7.9.7 Purpose

This Submessage is used to send a timestamp which applies to the Submessages that follow within the same message.

8.3.7.9.8 Content

The elements that form the structure of the **InfoTimestamp** message are described in the table below.

Table 8.44 - Structure of the InfoTimestamp Submessage

element	type	meaning
<i>EndiannessFlag</i>	SubmessageFlag	Appears in the Submessage header flags. Indicates endianness.
<i>InvalidateFlag</i>	SubmessageFlag	Indicates whether subsequent Submessages should be considered as having a timestamp or not
<i>timestamp</i>	Timestamp	Present only if the InvalidateFlag is not set in the header. Contains the timestamp that should be used to interpret the subsequent Submessages.

8.3.7.9.9 Validity

This Submessage is *invalid* when any of the following is true:

- *submessageLength* in the Submessage header is too small.

8.3.7.9.10 Change in state of Receiver

```
if ( !InfoTimestamp.InvalidateFlag ) {
    Receiver.haveTimestamp = true
    Receiver.timestamp     = InfoTimestamp.timestamp
} else {
    Receiver.haveTimestamp = false
}
```

8.3.7.9.11 Logical Interpretation

None

8.3.7.10 NackFrag

8.3.7.10.1 Purpose

The **NackFrag** Submessage is used to communicate the state of a **Reader** to a **Writer**. When a data change is sent as a series of fragments, the **NackFrag** Submessage allows the Reader to inform the Writer about specific fragment numbers it is still missing.

This Submessage can only contain negative acknowledgements. Note this differs from an **AckNack** Submessage, which includes both positive and negative acknowledgements. The advantages of this approach include:

- It removes the windowing limitation introduced by the **AckNack** Submessage.
Given the size of a *SequenceNumberSet* is limited to 256, an **AckNack** Submessage is limited to NACKing only those samples whose sequence number does not exceed that of the first missing sample by more than 256. Any samples below the first missing samples are acknowledged.
NackFrag Submessages on the other hand can be used to NACK any fragment numbers, even fragments more than 256 apart from those NACKed in an earlier **AckNack** Submessage. This becomes important when handling samples

containing a large number of fragments.

- Fragments can be negatively acknowledged in any order.

8.3.7.10.2 Content

The elements that form the structure of the **NackFrag** message are described in the table below.

Table 8.45 - Structure of the NackFrag SubMessage

element	type	meaning
<i>EndiannessFlag</i>	SubmessageFlag	Appears in the Submessage header flags. Indicates endianness.
<i>readerId</i>	EntityId	Identifies the Reader entity that requests to receive certain fragments.
<i>writerId</i>	EntityId	Identifies the Writer entity that is the target of the NackFrag message. This is the Writer Entity that is being asked to re-send some fragments.
<i>writerSN</i>	SequenceNumber	The sequence number for which some fragments are missing.
<i>fragmentNumberState</i>	FragmentNumberSet	Communicates the state of the reader to the writer. The fragment numbers that appear in the set indicate missing fragments on the reader side. The ones that do not appear in the set are undetermined (could have been received or not).
<i>count</i>	Count	A counter that is incremented each time a new NackFrag message is sent. Provides the means for a Writer to detect duplicate NackFrag messages that can result from the presence of redundant communication paths.

8.3.7.10.3 Validity

This Submessage is *invalid* when any of the following is true:

- *submessageLength* in the Submessage header is too small.
- *writerSN.value* is zero or negative.
- *fragmentNumberState* is invalid (as defined in Section 8.3.5.7).

8.3.7.10.4 Change in state of Receiver

None

8.3.7.10.5 Logical Interpretation

The **Reader** sends the **NackFrag** message to the **Writer** to request fragments from the **Writer**.

The Writer is uniquely identified by its GUID. The Writer GUID is obtained using the state of the Receiver:

```
writerGUID = { Receiver.destGuidPrefix, NackFrag.writerId }
```

The Reader is uniquely identified by its GUID. The Reader GUID is obtained using the state of the Receiver:

```
readerGUID = { Receiver.sourceGuidPrefix, NackFrag.readerId }
```

The sequence number from which fragments are requested is given by *writerSN*. The mechanism to explicitly represent fragment numbers depends on the PSM. Typically, a compact representation (such as a bitmap) is used.

8.3.7.11 Pad

8.3.7.11.1 Purpose

The purpose of this Submessage is to allow the introduction of any padding necessary to meet any desired memory-alignment requirements. Its has no other meaning.

8.3.7.11.2 Content

This Submessage has no contents. It accomplishes its purposes with only the Submessage header part. The amount of padding is determined by the value of *submessageLength*.

8.3.7.11.3 Validity

This Submessage is always valid.

8.3.7.11.4 Change in state of Receiver

None

8.3.7.11.5 Logical Interpretation

None

~~NoKeyData~~

~~This Submessage is sent from an RTPS *Writer* with *topic_kind*==**NO_KEY** to an RTPS *Reader* with *topic_kind*==**NO_KEY**.~~

~~Purpose~~

~~The Submessage notifies the RTPS *Reader* of a change to the value of the single data-object belonging to the RTPS *Writer*.~~

~~This Submessage can be considered an optimization of the *Data* message usable in the simpler case where the writer is writing a *Topic* that has no key.~~

~~Contents~~

The elements that form the structure of the **NoKeyData** message are described in the table below:

Table 8.46 ~~Structure of the NoKeyData Submessage~~

element	type	meaning
<i>EndiannessFlag</i>	SubmessageFlag	Appears in the Submessage header flags. Indicates endianness.
<i>InlineQosFlag</i>	SubmessageFlag	Appears in the Submessage header flags. Indicates to the Reader the presence of a ParameterList containing QoS parameters that should be used to interpret the message.
<i>DataFlag</i>	SubmessageFlag	Appears in the Submessage header flags. Indicates to the Reader this Submessage contains valid serialized data.
<i>readerId</i>	EntityId	Identifies the Reader Entity that is being informed of the change to the data object.
<i>writerId</i>	EntityId	Identifies the Writer Entity that made the change to the data object.
<i>writerSN</i>	SequenceNumber	Uniquely identifies the change and the relative order for all changes made by the Writer identified by the writerGuid. Each change gets a consecutive sequence number. Each writer maintains its own sequence number.
<i>inlineQos</i>	ParameterList	Present only if the <i>InlineQosFlag</i> is set in the header. Contains QoS that may affect the interpretation of the message.
<i>serializedData</i>	SerializedData	Present only if the <i>DataFlag</i> is set in the header. Encapsulation of the new value of the data object after the change.

Validity

This Submessage is *invalid* when any of the following is true:

submessageLength in the Submessage header is too small.

writerSN.value is not strictly positive (1, 2, ...) or is **SEQUENCENUMBER_UNKNOWN**.

inlineQos is invalid.

Change in state of Receiver

None

Logical Interpretation

The RTPS **Writer** sends the **NoKeyData** Submessage to the RTPS **Reader** to communicate changes in the value of its data object.

~~There are no implied changes to the lifecycle because the value refers to a Topic with *topic_kind*==NO_KEY.~~

~~The new value is encapsulated in the *serializedData*, unless the *DataFlag* is not set. In that case, the Submessage may indicate an event with no associated data, such as the end of a coherent set of changes.~~

~~If the *InlineQosFlag* is set, the *inlineQos* contains QoS values that override those of the RTPS *Writer* and should be used to process the update. For a complete list of possible in-line QoS parameters, see Table 9.14.~~

~~The Writer is uniquely identified by its GUID. The Writer GUID is obtained using the state of the Receiver:~~

~~writerGUID = { Receiver.sourceGuidPrefix, NoKeyData.writerId }~~

~~The Reader is uniquely identified by its GUID. The Reader GUID is obtained using the state of the Receiver:~~

~~readerGUID = { Receiver.destGuidPrefix, NoKeyData.readerId }~~

~~The *readerId.value* can be ENTITYID_UNKNOWN, in which case the *NoKeyData* applies to all *Readers* of that *writerGUID* within the *Participant* identified by the *GuidPrefix_t* Receiver.destGuidPrefix.~~

~~NoKeyDataFrag~~

~~This Submessage is sent from an RTPS *Writer* with *topic_kind*==NO_KEY to an RTPS *Reader* with *topic_kind*==NO_KEY.~~

~~Purpose~~

~~The *NoKeyDataFrag* Submessage enables serialized data to be fragmented and sent as multiple *NoKeyDataFrag* Submessages. The fragments contained in the *NoKeyDataFrag* Submessages are then re-assembled by the RTPS *Reader*.~~

~~This Submessage can be considered an optimization of the *DataFrag* Submessage usable in the simpler case where the writer is writing a Topic that has no key.~~

~~Contents~~

~~The elements that form the structure of the *NoKeyDataFrag* Submessage are described in the table below.~~

Table 8.47 – Structure of the NoKeyDataFrag Submessage

element	type	meaning
<i>EndiannessFlag</i>	SubmessageFlag	Appears in the Submessage header flags. Indicates endianness.
<i>InlineQosFlag</i>	SubmessageFlag	Appears in the Submessage header flags. Indicates to the Reader the presence of a ParameterList containing QoS parameters that should be used to interpret the message.
<i>readerId</i>	EntityId	Identifies the RTPS <i>Reader</i> entity that is being informed of the change to the data object.
<i>writerId</i>	EntityId	Identifies the RTPS <i>Writer</i> entity that made the change to the data object.

Table 8.47 – Structure of the NoKeyDataFrag Submessage

element	type	meaning
<i>writerSN</i>	SequenceNumber	Uniquely identifies the change and the relative order for all changes made by the RTPS <i>Writer</i> identified by the <i>writerGuid</i> . Each change gets a consecutive sequence number. Each RTPS <i>Writer</i> maintains its own sequence number.
<i>fragmentStartingNum</i>	FragmentNumber	Indicates the starting fragment for the series of fragments in <i>serializedData</i> . Fragment numbering starts with number 1.
<i>fragmentsInSubmessage</i>	ushort	The number of consecutive fragments contained in this Submessage, starting at <i>fragmentStartingNum</i> .
<i>dataSize</i>	ulong	The total size in bytes of the original data before fragmentation.
<i>fragmentSize</i>	ushort	The size of an individual fragment in bytes. The maximum fragment size equals 64K.
<i>inlineQos</i>	ParameterList	Present only if the <i>InlineQosFlag</i> is set in the header. Contains QoS that may affect the interpretation of the message.
<i>serializedData</i>	SerializedData	Encapsulation of a consecutive series of fragments, starting at <i>fragmentStartingNum</i> for a total of <i>fragmentsInSubmessage</i> . Represents part of the new value of the data object after the change.

Validity

This Submessage is *invalid* when any of the following is true:

submessageLength in the Submessage header is too small

writerSN.value is not strictly positive (1, 2, ...) or is **SEQUENCENUMBER_UNKNOWN**

fragmentStartingNum.value is not strictly positive (1, 2, ...) or exceeds the total number of fragments (see below)

fragmentSize exceeds *dataSize*

The size of *serializedData* exceeds *fragmentsInSubmessage* * *fragmentSize*

inlineQos is invalid

Change in state of Receiver

None

Logical Interpretation

~~The **NoKeyDataFrag** Submessage extends the **NoKeyData** Submessage by enabling the *serializedData* to be fragmented and sent as multiple **NoKeyDataFrag** Submessages. Once the *serializedData* is re-assembled by the RTPS **Reader**, the interpretation of the **NoKeyDataFrag** Submessages is identical to that of the **NoKeyData** Submessage.~~

~~How to re-assemble *serializedData* using the information in the **NoKeyDataFrag** Submessage is described below.~~

~~The total size of the data to be re-assembled is given by *dataSize*. Each **NoKeyDataFrag** Submessage contains a contiguous segment of this data in its *serializedData* element. The size of the segment is determined by the size of the *serializedData* element. During re-assembly, the offset of each segment is determined by:~~

~~$(\text{fragmentStartingNum} - 1) * \text{fragmentSize}$~~

~~The data is fully re-assembled when all fragments have been received. The total number of fragments to expect equals:~~

~~$\text{dataSize} / \text{fragmentSize} + (\text{dataSize} \% \text{fragmentSize}) ? 1 : 0$~~

~~Note that each **NoKeyDataFrag** Submessage may contain multiple fragments. An RTPS **Writer** will select *fragmentSize* based on the smallest message size supported across all underlying transports. If some RTPS **Readers** can be reached across a transport that supports larger messages, the RTPS **Writer** can pack multiple fragments in a single **NoKeyDataFrag** Submessage or may even send a regular **Data** Submessage if fragmentation is no longer required. For more details, see Section 8.4.14.1.~~

8.4 Behavior Module

This module describes the dynamic behavior of the RTPS entities. It describes the valid sequences of message exchanges between RTPS **Writer** endpoints and RTPS **Reader** endpoints and the timing constraints of those messages.

8.4.1 Overview

Once an RTPS **Writer** has been matched with an RTPS **Reader**, they are both responsible for ensuring that **CacheChange** changes that exist in the **Writer**'s **HistoryCache** are propagated to the **Reader**'s **HistoryCache**.

The Behavior Module describes how the matching RTPS **Writer** and **Reader** pair must behave in order to propagate **CacheChange** changes. The behavior is defined in terms of message exchanges using the RTPS Messages defined in Section 8.3.

The Behavior Module is organized as follows:

- Section 8.4.2 lists what requirements all implementations of the RTPS protocol must satisfy in terms of behavior. An implementation which satisfies these requirements is considered compliant and will be interoperable with other compliant implementations.
- As implied above, it is possible for multiple implementations to satisfy the minimum requirements, where each implementation may choose a different trade-off between memory requirements, bandwidth usage, scalability, and efficiency. The RTPS specification does not mandate a single implementation with corresponding behavior. Instead, it defines the minimum requirements for interoperability and then provides two Reference Implementations, the Stateless and Stateful Reference Implementations, described in Section 8.4.3.
- The protocol behavior depends on such settings as the RELIABILITY QoS and whether keyed topics are used or not. Section 8.4.4 discusses the possible combinations.
- Section 8.4.5 and Section 8.4.6 define notational conventions and define any new types used in this module.

- Section 8.4.7 through Section 8.4.12 model the two Reference Implementations.
- Section 8.4.14 discusses some optional behavior, including support for fragmented data.
- Finally, Section 8.4.15 provides guidelines for actual implementations.

Note that, as discussed earlier in Section 8.2.9, the Behavior Module does not model the interactions between DDS Entities and their corresponding RTPS entities. For example, it simply assumes a DDS DataWriter adds and removes *CacheChange* changes to and from its RTPS *Writer's HistoryCache*. Changes are added by the DDS DataWriter as part of its write operation and removed when no longer needed. It is important to realize the DDS DataWriter may remove a *CacheChange* before it has been propagated to one or more of the matched RTPS *Reader* endpoints. The RTPS *Writer* is not in control of when a *CacheChange* is removed from the *Writer's HistoryCache*. It is the responsibility of the DDS DataWriter to only remove those *CacheChange* changes that can be removed based on the communication status and the DDS DataWriter's QoS. For example, the HISTORY QoS setting of KEEP_LAST with a depth of 1 allows a DataWriter to remove a *CacheChange* if a more recent change replaces the value of the same data-object.

8.4.1.1 Example Behavior

The contents of this Section are not part of the formal specification of the protocol. The purpose of this section is to provide an intuitive understanding of the protocol.

A typical sequence illustrating the exchanges between an RTPS *Writer* and a matched RTPS *Reader* is shown in Figure 8.14. The example sequence in this case uses the Stateful Reference Implementation.

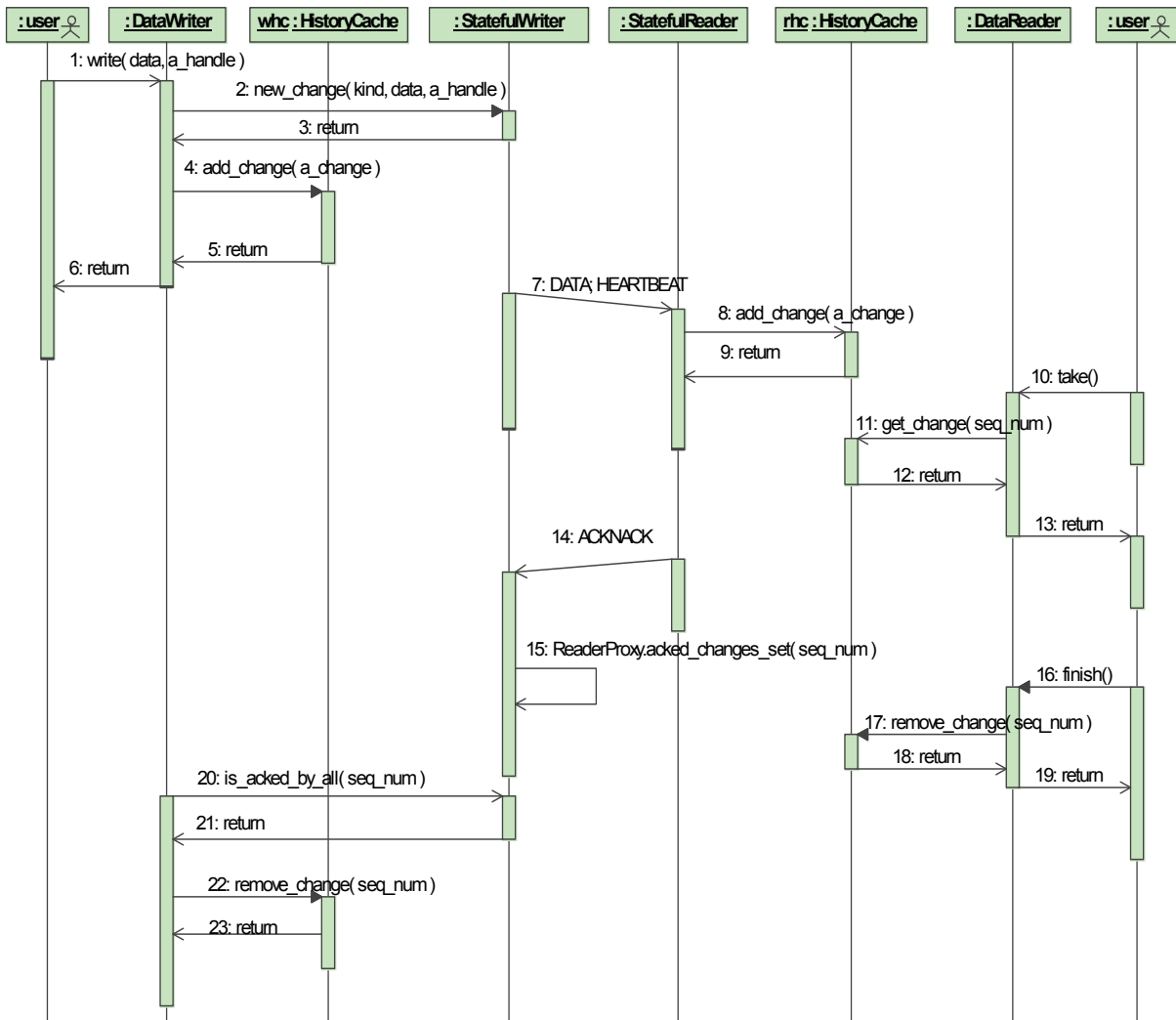

Figure 8.14 - Example Behavior

The individual interactions are described below:

1. The DDS user writes data by invoking the **write** operation on the DDS DataWriter.
2. The DDS DataWriter invokes the **new_change** operation on the RTPS Writer to create a new *CacheChange*. Each *CacheChange* is uniquely identified by a *SequenceNumber*.
3. The **new_change** operation returns.
4. The DDS DataWriter uses the **add_change** operation to store the CacheChange into the RTPS Writer's *HistoryCache*.
5. The **add_change** operation returns.
6. The **write** operation returns, the user has completed the action of writing Data.

7. The RTPS Writer sends the contents of the *CacheChange* changes to the RTPS *Reader* using the **Data** ~~(or the NoKeyData)~~ Submessage and requests an acknowledgment by also sending a **Heartbeat** Submessage.
8. The RTPS *Reader* receives the **Data** message and, assuming that the resource limits allow that, places the *CacheChange* into the reader's *HistoryCache* using the **add_change** operation.
9. The **add_change** operation returns. The *CacheChange* is visible to the DDS DataReader and the DDS user. The conditions for this depend on the *reliabilityLevel* attribute of the RTPS *Reader*.
 - a. For a RELIABLE DDS DataReader, changes in its RTPS Reader's *HistoryCache* are made visible to the user application only when all previous changes (i.e. changes with smaller sequence numbers) are also visible.
 - b. For a BEST_EFFORT DDS DataReader, changes in its RTPS Reader's *HistoryCache* are made visible to the user only if no future changes have already been made visible (i.e. if there are no changes in the RTPS Receiver's *HistoryCache* with a higher sequence number).
10. The DDS user is notified by one of the mechanisms described in the DDS Specification (e.g. by means of a listener or a WaitSet) and initiates reading of the data by calling the **take** operation on the DDS DataReader.
11. The DDS DataReader accesses the change using the **get_change** operation on the *HistoryCache*.
12. The **get_change** operation returns the *CacheChange* to the DataReader.
13. The **take** operation returns the data to the DDS user.
14. The RTPS *Reader* sends an **AckNack** message indicating that the *CacheChange* was placed into the Reader's *HistoryCache*. The **AckNack** message contains the *GUID* of the RTPS *Reader* and the *SequenceNumber* of the change. This action is independent from the notification to the DDS user and the reading of the data by the DDS user. It could have occurred before or concurrently with that.
15. The *StatefulWriter* records that the RTPS *Reader* has received the *CacheChange* and adds it to the set of *acked_changes* maintained by the *ReaderProxy* using the **acked_changes_set** operation.
16. The DDS user invokes the **finish** operation on the DataReader to indicate that it is no longer using the data it retrieved by means of the previous **take** operation. This action is independent from the actions on the writer side as it is initiated by the DDS user.
17. The DDS DataReader uses the **remove_change** operation to remove the data from the HistoryCache.
18. The **remove_change** operation returns
19. The **finish** operation returns
20. The DDS DataWriter uses the operation **is_acked_by_all** to determine which *CacheChanges* have been received by all the RTPS *Reader* endpoints matched with the *StatefulWriter*.
21. The **is_acked_by_all** returns and indicates that the change with the specified 'seq_num' *SequenceNumber* has been acknowledged by all RTPS *Reader* endpoints.
22. The DDS DataWriter uses the operation **remove_change** to remove the change associated with 'seq_num' from the RTPS Writer's *HistoryCache*. In doing this, the DDS DataWriter also takes into account other DDS QoS such as DURABILITY.
23. The operation **remove_change** returns.

The description above did not model some of the interactions between the DDS DataReader and the RTPS *Reader*; for example the mechanism used by the RTPS Reader to alert to the DataReader that it should call read or take to check whether new changes have been received (i.e., what causes step 10 to be taken).

Also unmodeled are some interactions between the DDS DataWriter and the RTPS *Writer*; such as the mechanism used by the RTPS *Writer* to alert to the DataWriter that it should check whether a particular change has been fully acknowledged such that it can be removed from the *HistoryCache* (i.e., what causes step 20 above to be initiated).

The aforementioned interactions are not modeled because they are internal to the implementation of the middleware and have no effect on the RTPS protocol.

8.4.2 Behavior Required for Interoperability

This section describes the requirements all implementations of the RTPS protocol must satisfy in order to be:

- compliant with the protocol specification
- interoperable with other implementations

The scope of these requirements is limited to message exchanges between RTPS implementations by different vendors. For message exchanges between implementations by the same vendor, vendors may opt for a non-compliant implementation or may use a proprietary protocol instead.

8.4.2.1 General Requirements

The following requirements apply to all RTPS Entities.

8.4.2.1.1 All communications must take place using RTPS Messages

No other messages can be used than the RTPS **Messages** defined in Section 8.3. The required contents, validity and interpretation of each Message is defined by the RTPS specification.

Vendors may extend Messages for vendor specific needs using the extension mechanisms provided by the protocol (see Section 8.6). This does not affect interoperability.

8.4.2.1.2 All implementations must implement the RTPS Message Receiver

Implementations must implement the rules followed by the RTPS **Message Receiver**, as introduced in Section 8.3.4, to interpret **Submessages** within the RTPS **Message** and maintain the state of the **Message Receiver**.

This requirement also includes proper Message formatting by preceding **Entity Submessages** with **Interpreter Submessages** when required for proper interpretation of the former, as defined in Section 8.3.7.

8.4.2.1.3 The timing characteristics of all implementations must be tunable

Depending on the application requirements, deployment configuration and underlying transports, the end-user may want to tune the timing characteristics of the RTPS protocol.

Therefore, where the requirements on the protocol behavior allow delayed responses or specify periodic events, implementations must allow the end-user to tune those timing characteristics.

8.4.2.1.4 Implementations must implement the Simple Participant and Endpoint Discovery Protocols

Implementations must implement the Simple Participant and Endpoint Discovery Protocols to enable the discovery of remote Endpoints (see Section 8.5).

RTPS allows the use of different Participant and Endpoint Discovery Protocols, depending on the deployment needs of the application. For the purpose of interoperability, implementations must implement at least the Simple Participant Discovery Protocol and Simple Endpoint Discovery Protocol (see Section 8.5.1).

8.4.2.2 Required RTPS Writer Behavior

The following requirements apply to RTPS *Writers* only. Unless indicated, the requirements apply to both reliable and best-effort *Writers*.

8.4.2.2.1 Writers must not send data out-of-order

A *Writer* must send out data samples in the order they were added to its *HistoryCache*.

8.4.2.2.2 Writers must include in-line QoS values if requested by a Reader

A *Writer* must honor a *Reader's* request to receive data messages with in-line QoS.

8.4.2.2.3 Writers must send periodic HEARTBEAT Messages (reliable only)

A *Writer* must periodically inform each matching reliable *Reader* of the availability of a data sample by sending a periodic HEARTBEAT Message that includes the sequence number of the available sample. If no samples are available, no HEARTBEAT Message needs to be sent.

For strict reliable communication, the *Writer* must continue to send HEARTBEAT Messages to a *Reader* until the *Reader* has either acknowledged receiving all available samples or has disappeared. In all other cases, the number of HEARTBEAT Messages sent can be implementation specific and may be finite.

8.4.2.2.4 Writers must eventually respond to a negative acknowledgment (reliable only)

When receiving an ACKNACK Message indicating a *Reader* is missing some data samples, the *Writer* must respond by either sending the missing data samples, sending a GAP message when the sample is not relevant, or sending a HEARTBEAT message when the sample is no longer available.

The *Writer* may respond immediately or choose to schedule the response for a certain time in the future. It can also coalesce related responses so there need not be a one-to-one correspondence between an ACKNACK Message and the *Writer's* response. These decisions and the timing characteristics are implementation specific.

8.4.2.3 Required RTPS Reader Behavior

A best-effort *Reader* is completely passive as it only receives data and does not send messages itself. Therefore, the requirements below only apply to reliable *Readers*.

8.4.2.3.1 Readers must respond eventually after receiving a HEARTBEAT with final flag not set

Upon receiving a HEARTBEAT Message with final flag not set, the *Reader* must respond with an ACKNACK Message. The ACKNACK Message may acknowledge having received all the data samples or may indicate that some data samples are missing.

The response may be delayed to avoid message storms.

8.4.2.3.2 Readers must respond eventually after receiving a HEARTBEAT that indicates a sample is missing

Upon receiving a HEARTBEAT Message, a *Reader* that is missing some data samples must respond with an ACKNACK Message indicating which data samples are missing. This requirement only applies if the *Reader* can accommodate these missing samples in its cache and is independent of the setting of the final flag in the HEARTBEAT Message.

The response may be delayed to avoid message storms.

The response is not required when a liveliness HEARTBEAT has both liveliness and final flags set to indicate it is a liveliness-only message.

8.4.2.3.3 Once acknowledged, always acknowledged

Once a *Reader* has positively acknowledged receiving a sample using an ACKNACK Message, it can no longer negatively acknowledge that same sample at a later point.

Once a *Writer* has received positive acknowledgement from all *Readers*, the *Writer* can reclaim any associated resources. However, if a *Writer* receives a negative acknowledgement to a previously positively acknowledged sample, and the *Writer* can still service the request, the *Writer* should send the sample.

8.4.2.3.4 Readers can only send an ACKNACK Message in response to a HEARTBEAT Message

In steady state, an ACKNACK Message can only be sent as a response to a HEARTBEAT Message from a *Writer*. ACKNACK Messages can be sent from a *Reader* when it first discovers a *Writer* as an optimization. *Writers* are not required to respond to these preemptive ACKNACK Messages.

8.4.3 Implementing the RTPS Protocol

The RTPS specification states that a compliant implementation of the protocol need only satisfy the requirements presented in Section 8.4.2. Therefore, the behavior of actual implementations may differ as a function of the design trade-offs made by each implementation.

The Behavior Module of the RTPS specification defines two reference implementations:

- **Stateless Reference Implementation:**
The Stateless Reference Implementation is optimized for scalability. It keeps virtually no state on remote entities and therefore scales very well with large systems. This involves a trade-off, as improved scalability and reduced memory usage may require additional bandwidth usage. The Stateless Reference Implementation is ideally suited for best-effort communication over multicast.
- **Stateful Reference Implementation:**
The Stateful Reference Implementation maintains full state on remote entities. This approach minimizes bandwidth usage, but requires more memory and may imply reduced scalability. In contrast to the Stateless Reference Implementation, it can guarantee strict reliable communication and is able to apply QoS-based or content-based filtering on the *Writer* side.

Both reference implementations are described in detail in the sections that follow.

Actual implementations need not necessarily follow the reference implementations. Depending on how much state is maintained, implementations may be a combination of the reference implementations.

For example, the Stateless Reference Implementation maintains minimal info and state on remote Entities. As such, it is not able to perform time-based filtering on the *Writer* side as this requires keeping track of each remote *Reader* and its properties. It is also not able to drop out-of-order samples on the *Reader* side as this requires keeping track of the largest sequence number received from each remote *Writer*. Some implementations may mimic the Stateless Reference Implementation, but choose to store enough additional state to be able to avoid some of the above limitations. The required additional information can be stored in a permanent fashion, in which case the implementation approaches the Stateful Reference Implementation, or can be slowly aged and kept around on an as-needed basis to approximate, to the extent possible, the behavior that would result if the state were maintained.

Regardless of the actual implementation, in order to guarantee interoperability, it is important that all implementations, including both reference implementations, satisfy the requirements presented in Section 8.4.2.

8.4.4 The Behavior of a Writer with respect to each matched Reader

The behavior of an RTPS *Writer* with respect to each matched *Reader* depends on:

- The setting of the *reliabilityLevel* attribute in the RTPS *Writer* and RTPS *Reader*. This controls whether a best-effort or a reliable protocol is used.
- The setting of the *topicKind* attribute in the RTPS *Writer* and *Reader*. This controls whether the data being communicated corresponds to a DDS Topic for which a Key has been defined.

Not all possible combinations of the *reliabilityLevel* and *topicKind* attribute are possible. An RTPS *Writer* cannot be matched to an RTPS *Reader* unless the following two conditions apply:

1. Both RTPS *Writer* and *Reader* must have the same value of the *topicKind* attribute. This is because they both relate to the same DDS Topic which will either be WITH_KEY or NO_KEY.
2. Either the RTPS *Writer* has the *reliabilityLevel* set to RELIABLE, or else both the RTPS *Writer* and RTPS *Reader* have the *reliabilityLevel* set to BEST_EFFORT. This is because the DDS specification states that a BEST_EFFORT DDS DataWriter can only be matched with a BEST_EFFORT DDS DataReader and a RELIABLE DDS DataWriter can be matched with both a RELIABLE and a BEST_EFFORT DDS DataReader.

As mentioned in Section 8.4.3, whether a *Writer* can be matched to a *Reader* does not depend on whether both use the same implementation of the RTPS protocol. That is, a Stateful Writer is able to communicate with a Stateless Reader and vice versa.

Table 8.43 summarizes the legal combinations supported by the protocol. Subsequent sections describe the behavior of each of the combinations listed.

Table 8.48 - Possible combinations of attributes for a matched RTPS Writer and RTPS Reader

Writer properties	Reader properties	Combination name
topicKind = WITH_KEY reliabilityLevel = BEST_EFFORT or reliabilityLevel = RELIABLE	topicKind = WITH_KEY reliabilityLevel = BEST_EFFORT	WITH_KEY Best-Effort
topicKind = NO_KEY reliabilityLevel = BEST_EFFORT or reliabilityLevel = RELIABLE	topicKind = NO_KEY reliabilityLevel = BEST_EFFORT	NO_KEY Best-Effort

Table 8.48 - Possible combinations of attributes for a matched RTPS Writer and RTPS Reader

Writer properties	Reader properties	Combination name
topicKind = WITH_KEY reliabilityLevel = RELIABLE	topicKind = WITH_KEY reliabilityLevel = RELIABLE	WITH_KEY Reliable
topicKind = NO_KEY reliabilityLevel = RELIABLE	topicKind = NO_KEY reliabilityLevel = RELIABLE	NO_KEY Reliable

8.4.5 Notational Conventions

The reference implementations are described using UML sequence charts and state-diagrams. These diagrams use some abbreviations to refer to the RTPS Entities. The abbreviations used are listed in Table 8.44.

Table 8.49 - Abbreviations used in the sequence charts and state diagrams of the Behavior Module

Acronym	Meaning	Example usage
DW	DDS DataWriter	DW::write
DR	DDS DataReader	DR::read
W	RTPS Writer	W::heartbeatPeriod
RP	RTPS ReaderProxy	RP::unicastLocatorList
RL	RTPS ReaderLocator	RL::locator
R	RTPS Reader	R::heartbeatResponseDelay
WP	RTPS WriterProxy	WP::remoteWriterGuid
WHC	HistoryCache of RTPS Writer	WHC::changes
RHC	HistoryCache of RTPS Reader	RHC::changes

8.4.6 Type Definitions

The Behavior Module introduces the following additional types.

Table 8.50 - Types definitions for the Behavior Module

Types used within the RTPS Model classes	
Attribute type	Purpose
Duration_t	Type used to hold time-differences. Should have at least nano-second resolution.

Table 8.50 - Types definitions for the Behavior Module

Types used within the RTPS Model classes	
Attribute type	Purpose
ChangeForReaderStatusKind	Enumeration used to indicate the status of a <i>ChangeForReader</i> . It can take the values: UNSENT, UNACKNOWLEDGED, REQUESTED, ACKNOWLEDGED, UNDERWAY
ChangeFromWriterStatusKind	Enumeration used to indicate the status of a <i>ChangeFromWriter</i> . It can take the values: LOST, MISSING, RECEIVED, UNKNOWN
InstanceHandle_t	Type used to represent the identity of a data-object whose changes in value are communicated by the RTPS protocol.
ParticipantMessageData	Type used to hold data exchanged between <i>Participants</i> . The most notable use of this type is for the <i>Writer</i> Liveliness Protocol.

8.4.7 RTPS Writer Reference Implementations

The RTPS *Writer* Reference Implementations are based on specializations of the RTPS *Writer* class, first introduced in Section 8.2. This section describes the RTPS *Writer* and all additional classes used to model the RTPS *Writer* Reference Implementations. The actual behavior is described in Section 8.4.8 and Section 8.4.9.

8.4.7.1 RTPS Writer

RTPS *Writer* specializes RTPS *Endpoint* and represents the actor that sends *CacheChange* messages to the matched RTPS *Reader* endpoints. The Reference Implementations *StatelessWriter* and *StatefulWriter* specialize RTPS *Writer* and differ in the knowledge they maintain about the matched *Reader* endpoints.

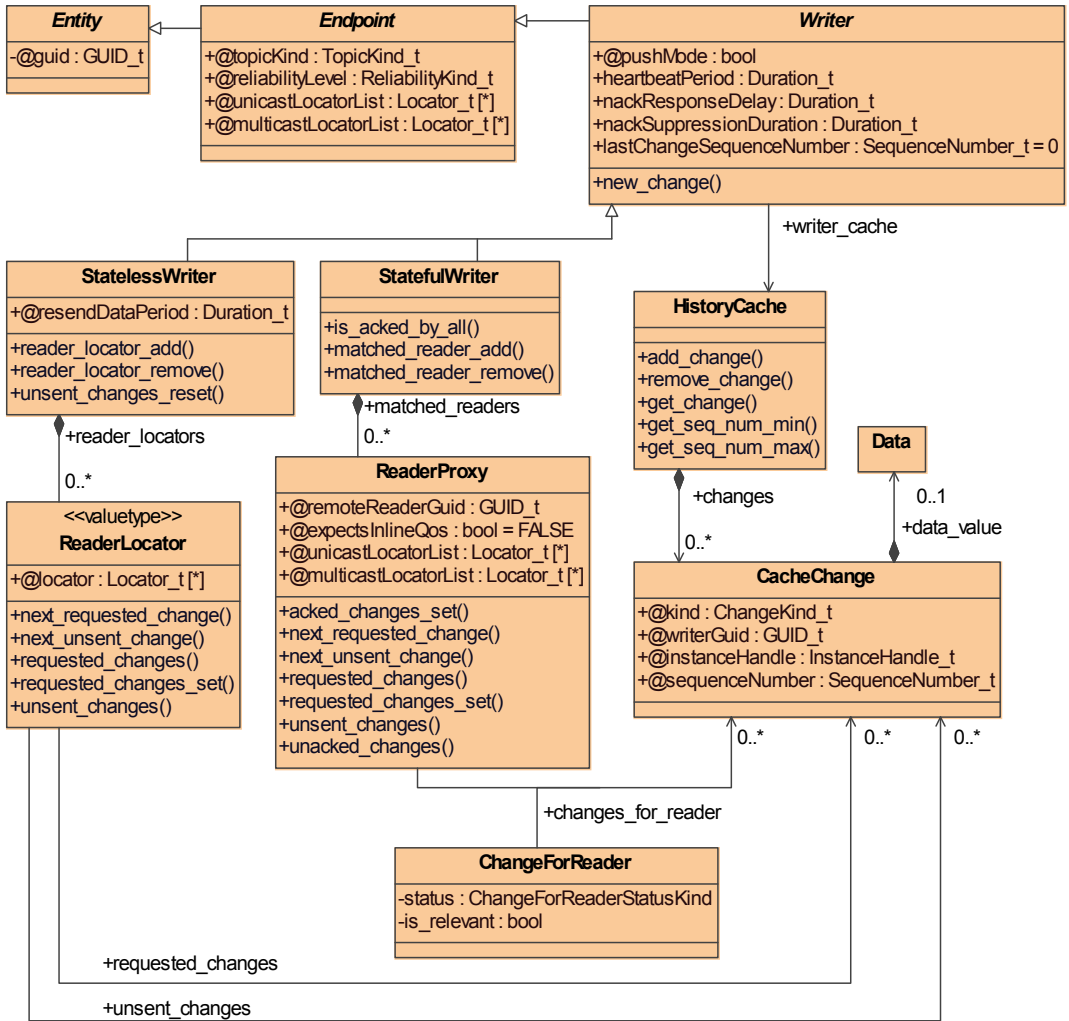

Figure 8.15 - RTPS Writer Endpoints

Table 8.46 describes the attributes of the RTPS *Writer*.

Table 8.51 - RTPS Writer Attributes

RTPS Writer : RTPS Endpoint			
attribute	type	meaning	relation to DDS
pushMode	bool	Configures the mode in which the Writer operates. If pushMode==true then the Writer will push changes to the reader. If pushMode==false changes will only be announced via heartbeats and only be sent as response to the request of a reader.	N/A (automatically configured).
heartbeatPeriod	Duration_t	Protocol tuning parameter that allows the RTPS <i>Writer</i> to repeatedly announce the availability of data by sending a Heartbeat Message.	N/A (automatically configured)
nackResponseDelay	Duration_t	Protocol tuning parameter that allows the RTPS <i>Writer</i> to delay the response to a request for data from a negative acknowledgment.	N/A (automatically configured)
nackSuppressionDuration	Duration_t	Protocol tuning parameter that allows the RTPS <i>Writer</i> to ignore requests for data from negative acknowledgments that arrive ‘too soon’ after the corresponding change is sent.	N/A (automatically configured)
lastChangeSequenceNumber	Sequence Number_t	Internal counter used to assign increasing sequence number to each change made by the Writer.	N/A (used as part of the logic of the virtual machine)
writer_cache	HistoryCache	Contains the history of CacheChange changes for this Writer.	N/A

The attributes of the RTPS *Writer* allow for fine-tuning of the protocol behavior. The operations of the RTPS *Writer* are described in Table 8.47.

Table 8.52 - RTPS Writer operations

RTPS Writer operations		
<i>operation name</i>	<i>parameter list</i>	<i>type</i>
new	<return value>	Writer
	attribute_values	Set of attribute values required by the Writer and all the super classes.
new_change	<return value>	CacheChange
	kind	ChangeKind_t
	data	Data
	handle	InstanceHandle_t

The following sections provide details on the operations.

8.4.7.1.1 Default Timing-Related Values

The following timing-related values are used as the defaults in order to facilitate ‘out-of-the-box’ interoperability between implementations.

```
nackResponseDelay.sec = 0;
```

```
nackResponseDelay.nanosec = 200 * 1000 * 1000; //200 milliseconds
```

```
nackSuppressionDuration.sec = 0;
```

```
nackSuppressionDuration.nanosec = 0;
```

8.4.7.1.2 new

This operation creates a new RTPS *Writer*.

The newly-created writer ‘this’ is initialized as follows:

```
this.guid := <as specified in the constructor>;
this.unicastLocatorList := <as specified in the constructor>;
this.multicastLocatorList := <as specified in the constructor>;
this.reliabilityLevel := <as specified in the constructor>;
this.topicKind := <as specified in the constructor>;
this.pushMode := <as specified in the constructor>;
this.heartbeatPeriod := <as specified in the constructor>;
this.nackResponseDelay := <as specified in the constructor>;
this.nackSuppressionDuration := <as specified in the constructor>;
this.lastChangeSequenceNumber := 0;
this.writer_cache := new HistoryCache;
```

8.4.7.1.3 new_change

This operation creates a new *CacheChange* to be appended to the RTPS *Writer*'s *HistoryCache*. The sequence number of the *CacheChange* is automatically set to be the *sequenceNumber* of the previous change plus one.

This operation returns the new change.

This operation performs the following logical steps:

```

++this.lastChangeSequenceNumber;
a_change := new CacheChange(kind, this.guid, this.lastChangeSequenceNumber,
    data, handle);
RETURN a_change;

```

8.4.7.2 RTPS StatelessWriter

Specialization of RTPS *Writer* used for the Stateless Reference Implementation. The RTPS *StatelessWriter* has no knowledge of the number of matched readers, nor does it maintain any state for each matched RTPS *Reader* endpoint. The RTPS *StatelessWriter* maintains only the RTPS *Locator_t* list that should be used to send information to the matched readers.

Table 8.53 - RTPS StatelessWriter attributes

RTPS StatelessWriter : RTPS Writer			
attribute	type	meaning	relation to DDS
resendDataPeriod	Duration_t	Protocol tuning parameter that indicates that the StatelessWriter re-sends all the changes in the writer's HistoryCache to all the Locators periodically each resendPeriod.	N/A. (Automatically configured)
reader_locators	ReaderLocator[*]	The StatelessWriter maintains the list of locators to which it sends the CacheChanges. This list may include both unicast and multicast locators.	N/A (Automatically configured)

The RTPS *StatelessWriter* is useful for situations where (a) the writer's *HistoryCache* is small, or (b) the communication is best-effort, or (c) the writer is communicating via multicast to a large number of readers.

The virtual machine interacts with the *StatelessWriter* using the operations in Table 8.49.

Table 8.54 - StatelessWriter operations

StatelessWriter operations		
<i>operation name</i>	<i>parameter list</i>	<i>type</i>
new	<return value>	StatelessWriter
	attribute_values	Set of attribute values required by the StatelessWriter and all the super classes.
reader_locator_add	<return value>	void
	a_locator	Locator_t
reader_locator_remove	<return value>	void
	a_locator	Locator_t
unsent_changes_reset	<return value>	void

8.4.7.2.1 new

This operation creates a new RTPS *StatelessWriter*.

In addition to the initialization performed on the RTPS *Writer* super class (Section 8.4.7.1.2), the newly-created *StatelessWriter* ‘this’ is initialized as follows:

```
this.readerlocators := <empty>;
this.resendDataPeriod := <as specified in the constructor>;
```

8.4.7.2.2 reader_locator_add

This operation adds the *Locator_t* *a_locator* to the StatelessWriter::reader_locators.

```
ADD a_locator TO {this.reader_locators};
```

8.4.7.2.3 reader_locator_remove

This operation removes the *Locator_t* *a_locator* from the StatelessWriter::reader_locators.

```
REMOVE a_locator FROM {this.reader_locators};
```

8.4.7.2.4 unsent_changes_reset

This operation modifies the set of ‘unsent_changes’ for all the *ReaderLocators* in the StatelessWriter::reader_locators. The list of unsent changes is reset to match the complete list of changes available in the writer’s *HistoryCache*.

```
FOREACH readerLocator in {this.reader_locators} DO
    readerLocator.unsent_changes := {this.writer_cache.changes}
```

8.4.7.3 RTPS ReaderLocator

Valuetype used by the RTPS *StatelessWriter* to keep track of the locators of all matching remote *Readers*.

Table 8.55 - RTPS ReaderLocator attributes

RTPS ReaderLocator			
attribute	type	meaning	relation to DDS
requested_changes	CacheChange[*]	A list of changes in the writer's HistoryCache that were requested by remote Readers at this ReaderLocator.	N/A. (Automatically configured)
unsent_changes	CacheChange[*]	A list of changes in the writer's HistoryCache that have not been sent yet to this ReaderLocator.	N/A. (Automatically configured)
locator	Locator_t	Unicast or multicast locator through which the readers represented by this ReaderLocator can be reached.	N/A (Automatically configured)
expectsInlineQos	bool	Specifies whether the readers represented by this ReaderLocator expect inline QoS to be sent with every Data Message.	

The virtual machine interacts with the *ReaderLocator* using the operations in Table 8.51.

Table 8.56 - ReaderLocator operations

ReaderLocator operations		
<i>operation name</i>	<i>parameter list</i>	<i>type</i>
new	<return value>	ReaderLocator
	attribute_values	Set of attribute values required by the ReaderLocator.
next_requested_change	<return value>	ChangeForReader
next_unsent_change	<return value>	ChangeForReader
requested_changes	<return value>	CacheChange[*]
requested_changes_set	<return value>	void
	req_seq_num_set	SequenceNumber_t[*]
unsent_changes	<return value>	CacheChange[*]

8.4.7.4 RTPS StatefulWriter

Specialization of RTPS *Writer* used for the Stateful Reference Implementation. The RTPS *StatefulWriter* is configured with the knowledge of all matched RTPS *Reader* endpoints and maintains state on each matched RTPS *Reader* endpoint.

By maintaining state on each matched RTPS *Reader* endpoint, the RTPS *StatefulWriter* can determine whether all matched RTPS *Reader* endpoints have received a particular *CacheChange* and can be optimal in its use of network bandwidth by avoiding to send announcements to readers that have received all the changes in the writer's *HistoryCache*. The information it maintains also simplifies QoS-based filtering on the *Writer* side. The attributes specific to the *StatefulWriter* are described in Table 8.52.

Table 8.57 - RTPS StatefulWriter Attributes

RTPS StatefulWriter : RTPS Writer			
attribute	type	meaning	relation to DDS
matched_readers	ReaderProxy[*]	The StatefulWriter keeps track of all the RTPS Readers matched with it. Each matched reader is represented by an instance of the ReaderProxy class.	N/A (Automatically configured)

The virtual machine interacts with the *StatefulWriter* using the operations in Table 8.53.

Table 8.58 - StatefulWriter Operations

StatefulWriter operations		
operation name	parameter list	type
new	<return value>	StatefulWriter
	attribute_values	Set of attribute values required by the StatefulWriter and all the super classes.
matched_reader_add	<return value>	void
	a_reader_proxy	ReaderProxy
matched_reader_remove	<return value>	void
	a_reader_proxy	ReaderProxy
matched_reader_lookup	<return value>	ReaderProxy
	a_reader_guid	GUID_t
is_acked_by_all	<return value>	bool
	a_change	CacheChange

8.4.7.4.1 new

This operation creates a new RTPS *StatefulWriter*. In addition to the initialization performed on the RTPS *Writer* super class (Section 8.4.7.1.2), the newly-created *StatefulWriter* ‘this’ is initialized as follows:

```
this.matched_readers := <empty>;
```

8.4.7.4.2 is_acked_by_all

This operation takes a *CacheChange a_change* as a parameter and determines whether all the *ReaderProxy* have acknowledged the CacheChange. The operation will return true if all ReaderProxy have acknowledged the corresponding CacheChange and false otherwise.

```
return true IF and only IF
  FOREACH proxy IN this.matched_readers
    IF change IN proxy.changes_for_reader THEN
      change.is_relevant == TRUE AND change.status == ACKNOWLEDGED
```

8.4.7.4.3 matched_reader_add

This operation adds the *ReaderProxy a_reader_proxy* to the set StatefulWriter::matched_readers.

```
ADD a_reader_proxy TO {this.matched_readers};
```

8.4.7.4.4 matched_reader_remove

This operation removes the *ReaderProxy a_reader_proxy* from the set StatefulWriter::matched_readers.

```
REMOVE a_reader_proxy FROM {this.matched_readers};
delete proxy;
```

8.4.7.4.5 matched_reader_lookup

This operation finds the *ReaderProxy* with GUID_t *a_reader_guid* from the set StatefulWriter::matched_readers.

```
FIND proxy IN this.matched_readers SUCH-THAT (proxy.remoteReaderGuid == a_reader_guid);
return proxy;
```

8.4.7.5 RTPS ReaderProxy

The RTPS *ReaderProxy* class represents the information an RTPS *StatefulWriter* maintains on each matched RTPS *Reader*. The attributes of the RTPS *ReaderProxy* are described in Table 8.54.

Table 8.59 - RTPS ReaderProxy Attributes

RTPS ReaderProxy			
attribute	type	meaning	relation to DDS
remoteReaderGuid	GUID_t	Identifies the remote matched RTPS Reader that is represented by the ReaderProxy.	N/A. Configured by discovery

Table 8.59 - RTPS ReaderProxy Attributes

RTPS ReaderProxy			
attribute	type	meaning	relation to DDS
unicastLocatorList	Locator_t[*]	List of unicast locators (transport, address, port combinations) that can be used to send messages to the matched RTPS <i>Reader</i> . The list may be empty.	N/A. Configured by discovery
multicastLocatorList	Locator_t[*]	List of multicast locators (transport, address, port combinations) that can be used to send messages to the matched RTPS <i>Reader</i> . The list may be empty.	N/A. Configured by discovery
changes_for_reader	CacheChange[*]	List of <i>CacheChange</i> changes as they relate to the matched RTPS <i>Reader</i> .	N/A. Used to implement the behavior of the RTPS protocol.
expectsInlineQos	bool	Specifies whether the remote matched RTPS Reader expects in-line QoS to be sent along with any data.	
isActive	bool	Specifies whether the remote <i>Reader</i> is responsive to the <i>Writer</i> .	N/A

The matching of an RTPS *StatefulWriter* with an RTPS *Reader* means that the RTPS *StatefulWriter* will send the *CacheChange* changes in the writer’s *HistoryCache* to the matched RTPS *Reader* represented by the *ReaderProxy*. The matching is a consequence of the match of the corresponding DDS entities. That is, the DDS DataWriter matches a DDS DataReader by Topic, has compatible QoS, and is not being explicitly ignored by the application that uses DDS.

The virtual machine interacts with the *ReaderProxy* using the operations in Table 8.55.

Table 8.60 - ReaderProxy Operations

ReaderProxy operations		
<i>operation name</i>	<i>parameter list</i>	<i>parameter type</i>
new	<return value>	ReaderProxy
	attribute_values	Set of attribute values required by the ReaderProxy.
acked_changes_set	<return value>	void
	committed_seq_num	SequenceNumber_t
next_requested_change	<return value>	ChangeForReader
next_unsent_change	<return value>	ChangeForReader
unsent_changes	<return value>	ChangeForReader[*]

Table 8.60 - ReaderProxy Operations

ReaderProxy operations		
<i>operation name</i>	<i>parameter list</i>	<i>parameter type</i>
requested_changes	<return value>	ChangeForReader[*]
requested_changes_set	<return value>	void
	req_seq_num_set	SequenceNumber_t[*]
unacked_changes	<return value>	ChangeForReader[*]

8.4.7.5.1 new

This operation creates a new RTPS *ReaderProxy*. The newly-created reader proxy ‘this’ is initialized as follows:

```

this.attributes := <as specified in the constructor>;
this.changes_for_reader := RTPS::Writer.writer_cache.changes;
FOR_EACH change IN (this.changes_for_reader) DO {
    IF ( DDS_FILTER(this, change) THEN change.is_relevant := FALSE;
    ELSE change.is_relevant := TRUE;

    IF ( RTPS::Writer.pushMode == true) THEN change.status := UNSENT;
    ELSE change.status := UNACKNOWLEDGED;
}

```

The above logic indicates that the newly-created *ReaderProxy* initializes its set of ‘changes_for_reader’ to contain all the *CacheChanges* in the *Writer*’s *HistoryCache*.

The change is marked as ‘irrelevant’ if the application of any of the DDS-DataReader filters indicates the change is not relevant to that particular reader. The DDS specification indicates that a *DataReader* may provide a time-based filter as well as a content-based filter. These filters should be applied in a manner consistent with the DDS specification to select any changes that are irrelevant to the *DataReader*.

The status is set depending on the value of the RTPS *Writer* attribute ‘pushMode.’

8.4.7.5.2 acked_changes_set

This operation changes the *ChangeForReader* status of a set of changes for the reader represented by *ReaderProxy* ‘the_reader_proxy.’ The set of changes with sequence number smaller than or equal to the value ‘committed_seq_num’ have their status changed to ACKNOWLEDGED.

```

FOR_EACH change in this.changes_for_reader
    SUCH-THAT (change.sequenceNumber <= committed_seq_num) DO
        change.status := ACKNOWLEDGED;

```

8.4.7.5.3 next_requested_change

This operation returns the *ChangeForReader* for the *ReaderProxy* that has the lowest sequence number among the changes with status ‘REQUESTED.’ This represents the next repair packet that should be sent to the RTPS *Reader* represented by the *ReaderProxy* in response to a previous *AckNack* message (see Section 8.3.7.1) from the *Reader*.

```

next_seq_num := MIN {change.sequenceNumber SUCH-THAT change IN this.requested_changes()}
return change IN this.requested_changes() SUCH-THAT (change.sequenceNumber ==
                                                    next_seq_num);

```

8.4.7.5.4 next_unsent_change

This operation returns the *CacheChange* for the *ReaderProxy* that has the lowest sequence number among the changes with status 'UNSENT.' This represents the next change that should be sent to the RTPS *Reader* represented by the *ReaderProxy*.

```

next_seq_num := MIN { change.sequenceNumber SUCH-THAT change IN this.unsent_changes() };
return change IN this.unsent_changes() SUCH-THAT (change.sequenceNumber ==
                                                    next_seq_num);

```

8.4.7.5.5 requested_changes

This operation returns the subset of changes for the *ReaderProxy* that have status 'REQUESTED.' This represents the set of changes that were requested by the RTPS *Reader* represented by the *ReaderProxy* using an ACKNACK Message.

```

return change IN this.changes_for_reader SUCH-THAT (change.status == REQUESTED);

```

8.4.7.5.6 requested_changes_set

This operation modifies the *ChangeForReader* status of a set of changes for the RTPS *Reader* represented by *ReaderProxy* 'this.' The set of changes with sequence numbers 'req_seq_num_set' have their status changed to REQUESTED.

```

FOR_EACH seq_num IN req_seq_num_set DO
  FIND change_for_reader IN this.changes_for_reader
    SUCH-THAT (change_for_reader.sequenceNumber==seq_num)
  change_for_reader.status := REQUESTED;
END

```

8.4.7.5.7 unsent_changes

This operation returns the subset of changes for the *ReaderProxy* the have status 'UNSENT.' This represents the set of changes that have not been sent to the RTPS *Reader* represented by the *ReaderProxy*.

```

return change IN this.changes_for_reader SUCH-THAT (change.status == UNSENT);

```

8.4.7.5.8 unacked_changes

This operation returns the subset of changes for the *ReaderProxy* that have status 'UNACKNOWLEDGED.' This represents the set of changes that have not been acknowledged yet by the RTPS *Reader* represented by the *ReaderProxy*.

```

return change IN this.changes_for_reader SUCH-THAT (change.status == UNACKNOWLEDGED);

```

8.4.7.6 RTPS ChangeForReader

The RTPS *ChangeForReader* is an association class that maintains information of a *CacheChange* in the RTPS *WriterHistoryCache* as it pertains to the RTPS *Reader* represented by the *ReaderProxy*. The attributes of the RTPS *ChangeForReader* are described in Table 8.56.

Table 8.61 - RTPS ChangeForReader Attributes

RTPS ReaderProxy			
attribute	type	meaning	relation to DDS
status	ChangeForReaderStatus Kind	Indicates the status of a CacheChange relative to the RTPS Reader represented by the ReaderProxy.	N/A. Used by the protocol.
isRelevant	bool	Indicates whether the change is relevant to the RTPS Reader represented by the ReaderProxy.	The determination of irrelevant changes is affected by DDS DataReader TIME_BASED_FILTER QoS and also by the use of DDS ContentFilteredTopics.

8.4.8 RTPS StatelessWriter Behavior

8.4.8.1 Best-Effort StatelessWriter Behavior

The behavior of the WITH_KEY Best-Effort RTPS *StatelessWriter* with respect to each *ReaderLocator* is described in Figure 8.16. ~~In the case of a NO_KEY Best-Effort *StatelessWriter*, the protocol remains identical, but the NoKeyData-Submessage is used instead of the Data-Submessage.~~

~~As described in Section , the NoKeyData-Submessage is a simplified version of the Data-Submessage that omits the keyHashPrefix and keyHashSuffix fields that would indicate the instance of the data object to which the change applies. These fields are not needed because without keys, the Topic implicitly has only a single data object.~~

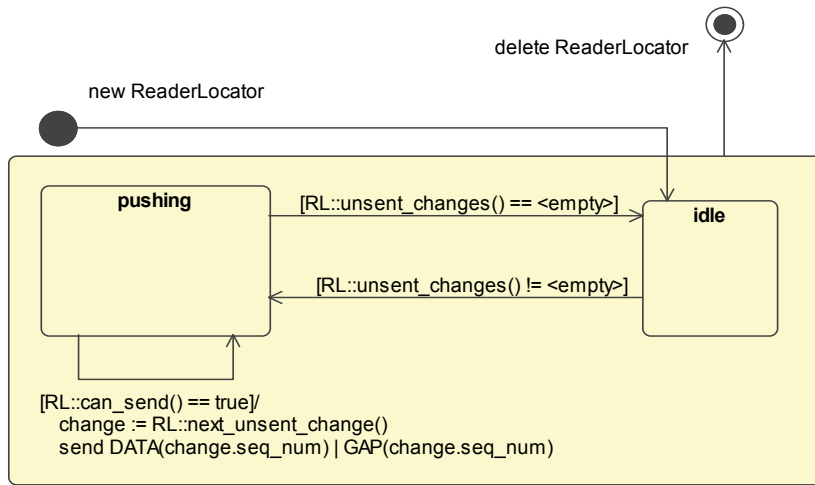

Figure 8.16 - Behavior of the WITH_KEY Best-Effort StatelessWriter with respect to each ReaderLocator

The state-machine transitions are listed in Table 8.57.

Table 8.62 - Transitions for Best-effort StatelessWriter behavior with respect to each ReaderLocator

Transition	state	event	next state
T1	initial	RTPS Writer is configured with a ReaderLocator	idle
T2	idle	GuardCondition: RL::unsent_changes() != <empty>	pushing
T3	pushing	GuardCondition: RL::unsent_changes() == <empty>	idle
T4	pushing	GuardCondition: RL::can_send() == true	pushing
T5	any state	RTPS Writer is configured to no longer have the ReaderLocator	final

8.4.8.1.1 Transition T1

This transition is triggered by the configuration of an RTPS Best-Effort *StatelessWriter* ‘the_rtps_writer’ with an RTPS *ReaderLocator*. This configuration is done by the Discovery protocol (Section 8.5) as a consequence of the discovery of a DDS DataReader that matches the DDS DataWriter that is related to ‘the_rtps_writer.’

The discovery protocol supplies the values for the *ReaderLocator* constructor parameters.

The transition performs the following logical actions in the virtual machine:

```
a_locator := new ReaderLocator( locator, expectsInlineQos );
the_rtps_writer.reader_locator_add( a_locator );
```

8.4.8.1.2 Transition T2

This transition is triggered by the guard condition [RL::unsent_changes() != <empty>] indicating that there are some changes in the RTPS *Writer HistoryCache* that have not been sent to the RTPS *ReaderLocator*.

The transition performs no logical actions in the virtual machine.

8.4.8.1.3 Transition T3

This transition is triggered by the guard condition [RL::unsent_changes() == <empty>] indicating that all changes in the RTPS *Writer HistoryCache* have been sent to the RTPS *ReaderLocator*. Note that this does not indicate that the changes have been received, only that an attempt was made to send them.

The transition performs no logical actions in the virtual machine.

8.4.8.1.4 Transition T4

This transition is triggered by the guard condition [RL::can_send() == true] indicating that the RTPS *Writer* ‘the_writer’ has the resources needed to send a change to the RTPS *ReaderLocator* ‘the_reader_locator.’

The transition performs the following logical actions in the virtual machine:

```
a_change := the_reader_locator.next_unsent_change();
DATA = new DATA(a_change);
IF (the_reader_locator.expectsInlineQos) {
    DATA.inlineQos := the_writer.related_dds_writer.qos;
}
DATA.readerId := ENTITYID_UNKNOWN;
sendto the_reader_locator.locator, DATA;
```

After the transition, the following post-conditions hold:

```
( a_change BELONGS-TO the_reader_locator.unsent_changes() ) == FALSE
```

8.4.8.1.5 Transition T5

This transition is triggered by the configuration of an RTPS *Writer* ‘the_rtps_writer’ to no longer send to the RTPS *ReaderLocator* ‘the_reader_locator.’ This configuration is done by the Discovery protocol (Section 8.5) as a consequence of breaking a pre-existing match of a DDS DataReader with the DDS DataWriter related to ‘the_rtps_writer.’

The transition performs the following logical actions in the virtual machine:

```
the_rtps_writer.reader_locator_remove(the_reader_locator);
delete the_reader_locator;
```

8.4.8.2 Reliable StatelessWriter Behavior

The behavior of the WITH_KEY reliable RTPS *StatelessWriter* with respect to each *ReaderLocator* is described in Figure 8.17. For a NO_KEY reliable *StatelessWriter*, the protocol remains identical ~~except that the NoKeyData-Submessage is used instead of the Data-Submessage.~~

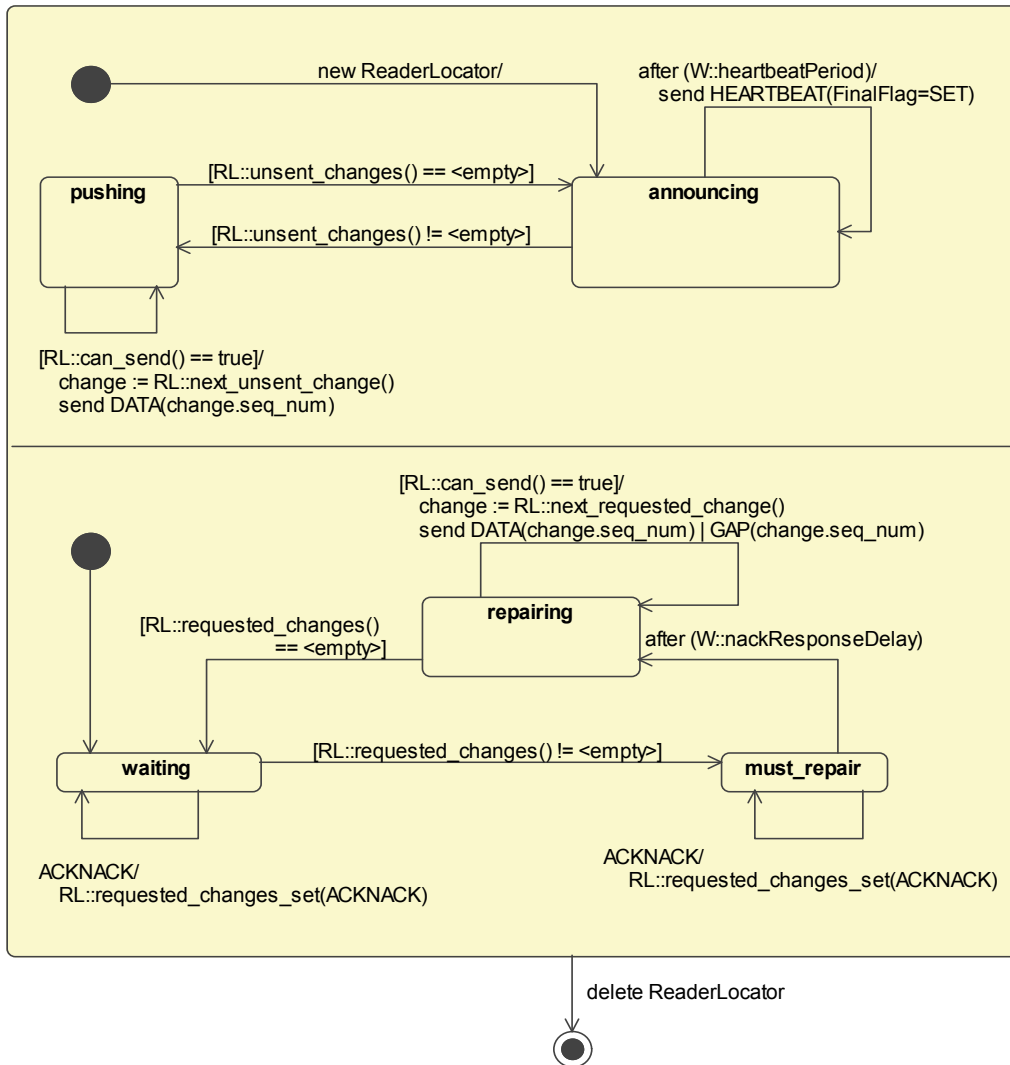

Figure 8.17 - Behavior of the WITH_KEY Reliable StatelessWriter with respect to each ReaderLocator

The state-machine transitions are listed in Table 8.58.

Table 8.63 - Transitions for the Reliable StatelessWriter behavior with respect to each ReaderLocator

Transition	state	event	next state
T1	initial	RTPS Writer is configured with a ReaderLocator	announcing
T2	announcing	GuardCondition: RL::unsent_changes() != <empty>	pushing

Table 8.63 - Transitions for the Reliable StatelessWriter behavior with respect to each ReaderLocator

Transition	state	event	next state
T3	pushing	GuardCondition: RL::unsent_changes() == <empty>	announcing
T4	pushing	GuardCondition: RL::can_send() == true	pushing
T5	announcing	after(W::heartbeatPeriod)	announcing
T6	waiting	ACKNACK message is received	waiting
T7	waiting	GuardCondition: RL::requested_changes() != <empty>	must_repair
T8	must_repair	ACKNACK message is received	must_repair
T9	must_repair	after(W::nackResponseDelay)	repairing
T10	repairing	GuardCondition: RL::can_send() == true	repairing
T11	repairing	GuardCondition: RL::requested_changes() == <empty>	waiting
T12	any state	RTPS Writer is configured to no longer have the ReaderLocator	final

8.4.8.2.1 Transition T1

This transition is triggered by the configuration of an RTPS Reliable *StatelessWriter* ‘the_rtps_writer’ with an RTPS *ReaderLocator*. This configuration is done by the Discovery protocol (8.5, ‘Discovery Module’) as a consequence of the discovery of a DDS DataReader that matches the DDS DataWriter that is related to ‘the_rtps_writer.’

The discovery protocol supplies the values for the *ReaderLocator* constructor parameters.

The transition performs the following logical actions in the virtual machine:

```
a_locator := new ReaderLocator( locator, expectsInlineQos );
the_rtps_writer.reader_locator_add( a_locator );
```

8.4.8.2.2 Transition T2

This transition is triggered by the guard condition [RL::unsent_changes() != <empty>] indicating that there are some changes in the RTPS *Writer HistoryCache* that have not been sent to the *ReaderLocator*. The transition performs no logical actions in the virtual machine.

8.4.8.2.3 Transition T3

This transition is triggered by the guard condition [RL::unsent_changes == <empty>] indicating that all changes in the RTPS *Writer HistoryCache* have been sent to the *ReaderLocator*. Note that this does not indicate that the changes have been received, only that there has been an attempt made to send them. The transition performs no logical actions in the virtual machine.

8.4.8.2.4 Transition T4

This transition is triggered by the guard condition [RL::can_send() == true] indicating that the RTPS *Writer* ‘the_writer’ has the resources needed to send a change to the RTPS *ReaderLocator* ‘the_reader_locator.’

The transition performs the following logical actions in the virtual machine:

```
a_change := the_reader_locator.next_unsent_change();
DATA = new DATA(a_change);
IF (the_reader_locator.expectsInlineQos) {
    DATA.inlineQos := the_writer.related_dds_writer.qos;
}
DATA.readerId := ENTITYID_UNKNOWN;
sendto the_reader_locator.locator, DATA;
```

After the transition the following post-conditions hold:

```
( a_change BELONGS-TO the_reader_locator.unsent_changes() ) == FALSE
```

8.4.8.2.5 Transition T5

This transition is triggered by the firing of a periodic timer configured to fire each W::heartbeatPeriod.

The transition performs the following logical actions in the virtual machine for the *Writer* ‘the_rtps_writer’ and *ReaderLocator* ‘the_reader_locator.’

```
seq_num_min := the_rtps_writer.writer_cache.get_seq_num_min();
seq_num_max := the_rtps_writer.writer_cache.get_seq_num_max();
HEARTBEAT := new HEARTBEAT(the_rtps_writer.writerGuid, seq_num_min, seq_num_max);
HEARTBEAT.FinalFlag := SET;
HEARTBEAT.readerId := ENTITYID_UNKNOWN;
sendto the_reader_locator, HEARTBEAT;
```

8.4.8.2.6 Transition T6

This transition is triggered by the reception of an ACKNACK message destined to the RTPS *StatelessWriter* ‘the_rtps_writer’ originating from some RTPS *Reader*.

The transition performs the following logical actions in the virtual machine:

```
FOREACH reply_locator_t IN { Receiver.unicastReplyLocatorList,
                             Receiver.multicastReplyLocatorList }
    reader_locator := the_rtps_writer.reader_locator_lookup(reply_locator_t);
    reader_locator.requested_changes_set(ACKNACK.readersNState.set);
```

Note that the processing of this message uses the reply locators in the RTPS *Receiver*. This is the only source of information for the StatelessWriter to determine where to send the reply to. Proper functioning of the protocol requires that the RTPS *Reader* inserts an **InfoReply** Submessage ahead of the **AckNack** such that these fields are properly set.

8.4.8.2.7 Transition T7

This transition is triggered by the guard condition [RL::requested_changes() != <empty>] indicating that there are changes that have been requested by some RTPS *Reader* reachable at the RTPS *ReaderLocator*. The transition performs no logical actions in the virtual machine.

8.4.8.2.8 Transition T8

This transition is triggered by the reception of an ACKNACK message destined to the RTPS *StatelessWriter* ‘the_rtps_writer’ originating from some RTPS *Reader*. The transition performs the same logical actions performed by Transition T6 (Section 8.4.8.2.6).

8.4.8.2.9 Transition T9

This transition is triggered by the firing of a timer indicating that the duration of W::nackResponseDelay has elapsed since the state **must_repair** was entered. The transition performs no logical actions in the virtual machine.

8.4.8.2.10 Transition T10

This transition is triggered by the guard condition [RL::can_send() == true] indicating that the RTPS *Writer* ‘the_writer’ has the resources needed to send a change to the RTPS *ReaderLocator* ‘the_reader_locator.’ The transition performs the following logical actions in the virtual machine.

```
a_change := the_reader_locator.next_requested_change();
IF a_change IN the_writer.writer_cache.changes {
    DATA = new DATA(a_change);
    IF (the_reader_locator.expectsInlineQos) {
        DATA.inlineQos := the_writer.related_dds_writer.qos;
    }
    DATA.readerId := ENTITYID_UNKNOWN;
    sendto the_reader_locator.locator, DATA;
}
ELSE {
    GAP = new GAP(a_change.sequenceNumber);
    GAP.readerId := ENTITYID_UNKNOWN;
    sendto the_reader_locator.locator, GAP;
}
```

After the transition the following post-conditions hold:

```
( a_change BELONGS-TO the_reader_locator.requested_changes() ) == FALSE
```

Note that it is possible that the requested change had already been removed from the *HistoryCache* by the DDS *DataWriter*. In that case, the *StatelessWriter* sends a GAP Message.

8.4.8.2.11 Transition T11

This transition is triggered by the guard condition [RL::requested_changes() == <empty>] indicating that there are no further changes requested by an RTPS *Reader* reachable at the RTPS *ReaderLocator*. The transition performs no logical actions in the virtual machine.

8.4.8.2.12 Transition T12

This transition is triggered by the configuration of an RTPS *Writer* ‘the_rtps_writer’ to no longer send to the RTPS *ReaderLocator* ‘the_reader_locator.’ This configuration is done by the Discovery protocol (Section 8.5) as a consequence of breaking a pre-existing match of a DDS DataReader with the DDS DataWriter related to ‘the_rtps_writer.’

The transition performs the following logical actions in the virtual machine:

```
the_rtps_writer.reader_locator_remove(the_reader_locator);
delete the_reader_locator;
```

8.4.9 RTPS StatefulWriter Behavior

8.4.9.1 Best-Effort StatefulWriter Behavior

The behavior of the WITH_KEY Best-Effort RTPS *StatefulWriter* with respect to each matched RTPS *Reader* is described in Figure 8.18. The behavior of a NO_KEY Best-Effort RTPS *StatefulWriter* is identical ~~except that NoKeyData-Submessages are used instead of Data-Submessages.~~

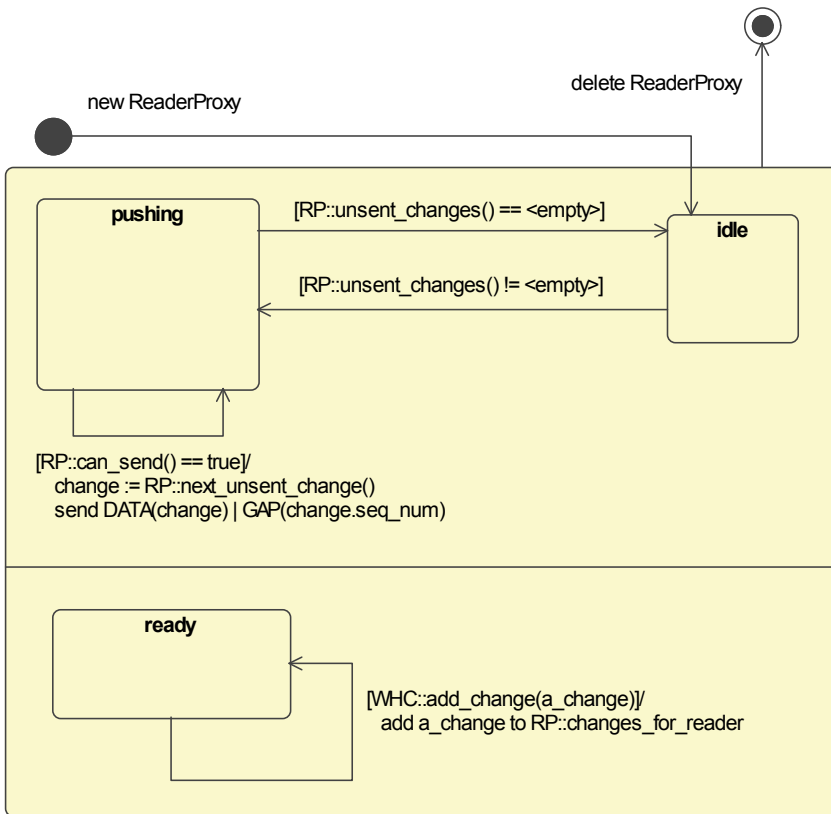

Figure 8.18 - Behavior of WITH_KEY Best-Effort StatefulWriter with respect to each matched Reader

The state-machine transitions are listed in Table 8.59.

Table 8.64 - Transitions for Best-effort Stateful Writer behavior with respect to each matched Reader

Transition	state	event	next state
T1	initial	RTPS Writer is configured with a matched RTPS Reader	idle
T2	idle	GuardCondition: RP::unsent_changes() != <empty>	pushing

Table 8.64 - Transitions for Best-effort Stateful Writer behavior with respect to each matched Reader

Transition	state	event	next state
T3	pushing	GuardCondition: RP::unsent_changes() == <empty>	idle
T4	pushing	GuardCondition: RP::can_send() == true	pushing
T5	ready	A new change was added to the RTPS Writer's HistoryCache.	ready
T6	any state	RTPS Writer is configured to no longer be matched with the RTPS Reader	final

8.4.9.1.1 Transition T1

This transition is triggered by the configuration of an RTPS *Writer* 'the_rtps_writer' with a matching RTPS *Reader*. This configuration is done by the Discovery protocol (Section 8.5) as a consequence of the discovery of a DDS DataReader that matches the DDS DataWriter that is related to 'the_rtps_writer.'

The discovery protocol supplies the values for the *ReaderProxy* constructor parameters.

The transition performs the following logical actions in the virtual machine:

```
a_reader_proxy := new ReaderProxy( remoteReaderGuid,
                                   expectsInlineQos,
                                   unicastLocatorList,
                                   multicastLocatorList);
the_rtps_writer.matched_reader_add(a_reader_proxy);
```

The *ReaderProxy* 'a_reader_proxy' is initialized as discussed in Section 8.4.7.5. This includes initializing the set of unsent changes and applying DDS_FILTER to each of the changes.

8.4.9.1.2 Transition T2

This transition is triggered by the guard condition [RP::unsent_changes() != <empty>] indicating that there are some changes in the RTPS *Writer HistoryCache* that have not been sent to the RTPS *Reader* represented by the *ReaderProxy*.

Note that for a Best-Effort *Writer*, W::pushMode == true, as there are no acknowledgements. Therefore, the *Writer* always pushes out data as it becomes available.

The transition performs no logical actions in the virtual machine.

8.4.9.1.3 Transition T3

This transition is triggered by the guard condition [RP::unsent_changes() == <empty>] indicating that all changes in the RTPS *Writer HistoryCache* have been sent to the RTPS *Reader* represented by the *ReaderProxy*. Note that this does not indicate that the changes have been received, only that there has been an attempt made to send them.

The transition performs no logical actions in the virtual machine.

8.4.9.1.4 Transition T4

This transition is triggered by the guard condition `[RP::can_send() == true]` indicating that the RTPS *Writer* ‘the_rtps_writer’ has the resources needed to send a change to the RTPS *Reader* represented by the *ReaderProxy* ‘the_reader_proxy.’

The transition performs the following logical actions in the virtual machine:

```
a_change := the_reader_proxy.next_unsent_change();
a_change.status := UNDERWAY;
if (a_change.is_relevant) {
    DATA = new DATA(a_change);
    IF (the_reader_proxy.expectsInlineQos) {
        DATA.inlineQos := the_rtps_writer.related_dds_writer.qos;
    }
    DATA.readerId := ENTITYID_UNKNOWN;
    send DATA;
}
```

The above logic is not meant to imply that each DATA Submessage is sent in a separate RTPS Message. Rather multiple Submessages can be combined into a single RTPS message.

After the transition, the following post-conditions hold:

```
( a_change BELONGS-TO the_reader_proxy.unsent_changes() ) == FALSE
```

8.4.9.1.5 Transition T5

This transition is triggered by the addition of a new *CacheChange* ‘a_change’ to the *HistoryCache* of the RTPS *Writer* ‘the_rtps_writer’ by the corresponding DDS DataWriter. Whether the change is relevant to the RTPS *Reader* represented by the *ReaderProxy* ‘the_reader_proxy’ is determined by the DDS_FILTER.

The transition performs the following logical actions in the virtual machine:

```
ADD a_change TO the_reader_proxy.changes_for_reader;
IF (DDS_FILTER(the_reader_proxy, change)) THEN change.is_relevant := FALSE;
ELSE change.is_relevant := TRUE;
IF (the_rtps_writer.pushMode == true) THEN change.status := UNSENT;
ELSE change.status := UNACKNOWLEDGED;
```

8.4.9.1.6 Transition T6

This transition is triggered by the configuration of an RTPS *Writer* ‘the_rtps_writer’ to no longer be matched with the RTPS *Reader* represented by the *ReaderProxy* ‘the_reader_proxy’. This configuration is done by the Discovery protocol (Section 8.5) as a consequence of breaking a pre-existing match of a DDS DataReader with the DDS DataWriter related to ‘the_rtps_writer.’

The transition performs the following logical actions in the virtual machine:

```
the_rtps_writer.matched_reader_remove(the_reader_proxy);
delete the_reader_proxy;
```

8.4.9.2 Reliable StatefulWriter Behavior

The behavior of the WITH_KEY Reliable RTPS *StatefulWriter* with respect to each matched RTPS *Reader* is described in Figure 8.19. The behavior of a NO_KEY Reliable RTPS *StatefulWriter* is identical ~~except that NoKeyData.~~

Submessages are used instead of **Data** Submessages.

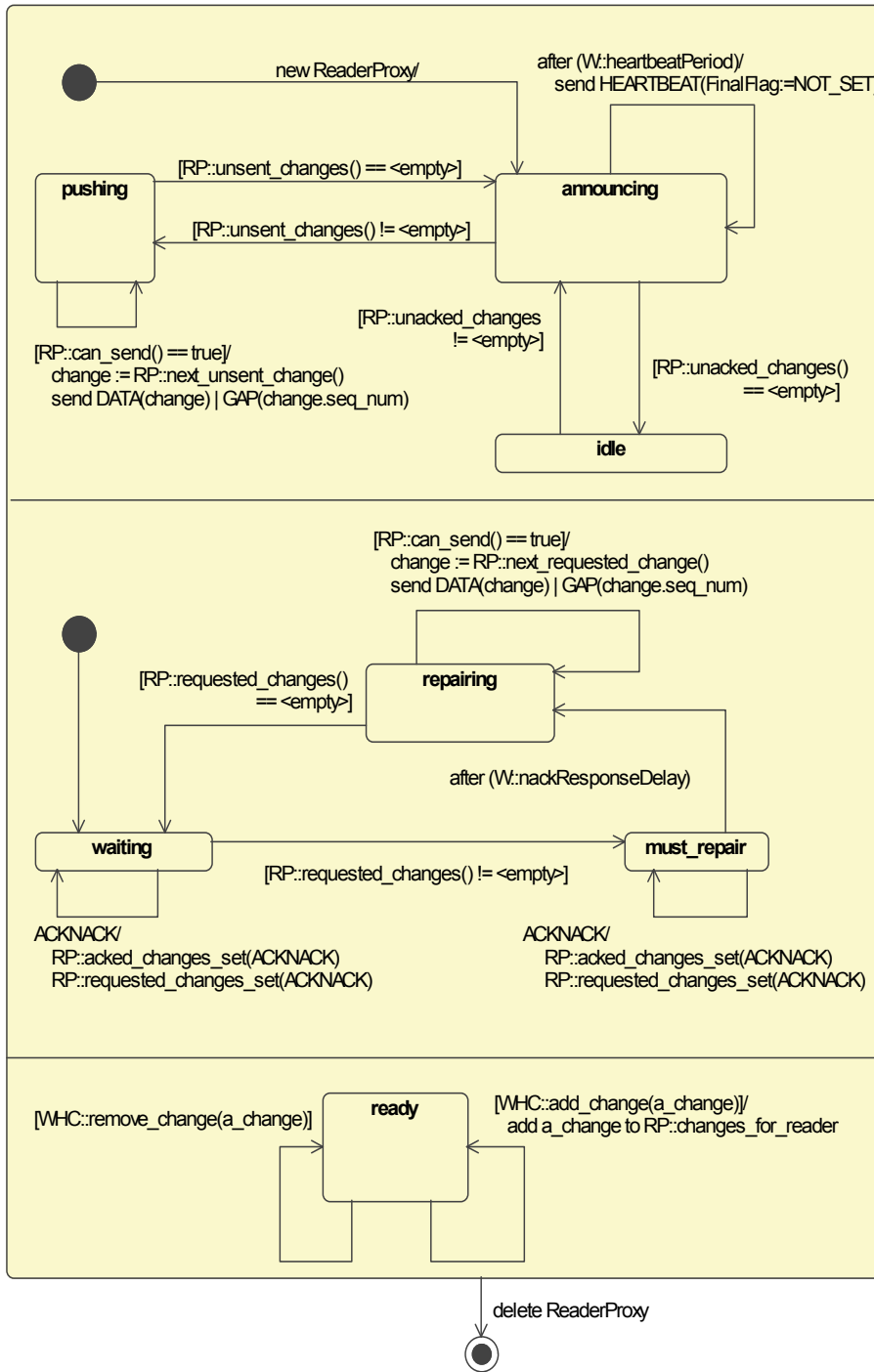

Figure 8.19 - Behavior of WITH_KEY Reliable StatefulWriter with respect to each matched Reader

The state-machine transitions are listed in Table 8.60.

Table 8.65 - Transitions for Reliable StatefulWriter behavior with respect to each matched Reader

Transition	state	event	next state
T1	initial	RTPS Writer is configured with a matched RTPS Reader	announcing
T2	announcing	GuardCondition: RP::unsent_changes() != <empty>	pushing
T3	pushing	GuardCondition: RP::unsent_changes() == <empty>	announcing
T4	pushing	GuardCondition: RP::can_send() == true	pushing
T5	announcing	GuardCondition: RP::unacked_changes() == <empty>	idle
T6	idle	GuardCondition: RP::unacked_changes() != <empty>	announcing
T7	announcing	after(W::heartbeatPeriod)	announcing
T8	waiting	ACKNACK message is received	waiting
T9	waiting	GuardCondition: RP::requested_changes() != <empty>	must_repair
T10	must_repair	ACKNACK message is received	must_repair
T11	must_repair	after(W::nackResponseDelay)	repairing
T12	repairing	GuardCondition: RP::can_send() == true	repairing
T13	repairing	GuardCondition: RP::requested_changes() == <empty>	waiting
T14	ready	A new change was added to the RTPS Writer's HistoryCache.	ready
T15	ready	A change was removed from the RTPS Writer's HistoryCache.	ready
T16	any state	RTPS Writer is configured to no longer be matched with the RTPS Reader	final

8.4.9.2.1 Transition T1

This transition is triggered by the configuration of an RTPS Reliable *StatefulWriter* ‘the_rtps_writer’ with a matching RTPS *Reader*. This configuration is done by the Discovery protocol (Section 8.5) as a consequence of the discovery of a DDS DataReader that matches the DDS DataWriter that is related to ‘the_rtps_writer.’

The discovery protocol supplies the values for the *ReaderProxy* constructor parameters.

The transition performs the following logical actions in the virtual machine:

```

a_reader_proxy := new ReaderProxy( remoteReaderGuid,
                                   expectsInlineQos,
                                   unicastLocatorList,
                                   multicastLocatorList);
the_rtps_writer.matched_reader_add(a_reader_proxy);

```

The *ReaderProxy* ‘a_reader_proxy’ is initialized as discussed in Section 8.4.7.5. This includes initializing the set of unsent changes and applying a filter to each of the changes.

8.4.9.2.2 Transition T2

This transition is triggered by the guard condition [RP::unsent_changes() != <empty>] indicating that there are some changes in the RTPS *Writer HistoryCache* that have not been sent to the RTPS *Reader* represented by the *ReaderProxy*.

The transition performs no logical actions in the virtual machine.

8.4.9.2.3 Transition T3

This transition is triggered by the guard condition [RP::unsent_changes() == <empty>] indicating that all changes in the RTPS *Writer HistoryCache* have been sent to the RTPS *Reader* represented by the *ReaderProxy*. Note that this does not indicate that the changes have been received, only that there has been an attempt made to send them.

The transition performs no logical actions in the virtual machine.

8.4.9.2.4 Transition T4

This transition is triggered by the guard condition [RP::can_send() == true] indicating that the RTPS *Writer* ‘the_rtps_writer’ has the resources needed to send a change to the RTPS *Reader* represented by the *ReaderProxy* ‘the_reader_proxy.’

The transition performs the following logical actions in the virtual machine:

```

a_change := the_reader_proxy.next_unsent_change();
a_change.status := UNDERWAY;
if (a_change.is_relevant) {
    DATA = new DATA(a_change);
    IF (the_reader_proxy.expectsInlineQos) {
        DATA.inlineQos := the_rtps_writer.related_dds_writer.qos;
    }
    DATA.readerId := ENTITYID_UNKNOWN;
    send DATA;
}
else {
    GAP = new GAP(a_change.sequenceNumber);
    GAP.readerId := ENTITYID_UNKNOWN;
    send GAP;
}

```

The above logic is not meant to imply that each DATA or GAP Submessage is sent in a separate RTPS Message. Rather multiple Submessages can be combined into a single RTPS message.

The above illustrates the simplified case where a GAP Submessage includes a single sequence number. This would result in potentially many Submessages in cases where many sequence numbers in close proximity refer to changes that are not relevant to the Reader. Efficient implementations will combine multiple ‘irrelevant’ sequence numbers as much as possible into a single GAP message.

After the transition, the following post-conditions hold:

```
( a_change BELONGS-TO the_reader_proxy.unacked_changes() ) == FALSE
```

8.4.9.2.5 Transition T5

This transition is triggered by the guard condition [RP::unacked_changes() == <empty>] indicating that all changes in the RTPS *Writer HistoryCache* have been acknowledged by the RTPS *Reader* represented by the *ReaderProxy*.

The transition performs no logical actions in the virtual machine.

8.4.9.2.6 Transition T6

This transition is triggered by the guard condition [RP::unacked_changes() != <empty>] indicating that there are changes in the RTPS *Writer HistoryCache* have not been acknowledged by the RTPS *Reader* represented by the *ReaderProxy*.

The transition performs no logical actions in the virtual machine.

8.4.9.2.7 Transition T7

This transition is triggered by the firing of a periodic timer configured to fire each W::heartbeatPeriod.

The transition performs the following logical actions for the *StatefulWriter* ‘the_rtps_writer’ in the virtual machine:

```
seq_num_min := the_rtps_writer.writer_cache.get_seq_num_min();
seq_num_max := the_rtps_writer.writer_cache.get_seq_num_max();
HEARTBEAT := new HEARTBEAT(the_rtps_writer.writerGuid, seq_num_min, seq_num_max);
HEARTBEAT.FinalFlag := NOT_SET;
HEARTBEAT.readerId := ENTITYID_UNKNOWN;
send HEARTBEAT;
```

8.4.9.2.8 Transition T8

This transition is triggered by the reception of an ACKNACK Message destined to the RTPS *StatefulWriter* ‘the_rtps_writer’ originating from the RTPS *Reader* represented by the *ReaderProxy* ‘the_reader_proxy.’

The transition performs the following logical actions in the virtual machine:

```
the_rtps_writer.acked_changes_set(ACKNACK.readerSNState.base - 1);
the_reader_proxy.requested_changes_set(ACKNACK.readerSNState.set);
```

After the transition the following post-conditions hold:

```
MIN { change.sequenceNumber IN the_reader_proxy.unacked_changes() } >=
    ACKNACK.readerSNState.base - 1
```

8.4.9.2.9 Transition T9

This transition is triggered by the guard condition [RP::requested_changes() != <empty>] indicating that there are changes that have been requested by the RTPS *Reader* represented by the *ReaderProxy*.

The transition performs no logical actions in the virtual machine.

8.4.9.2.10 Transition T10

This transition is triggered by the reception of an ACKNACK message destined to the RTPS *StatefulWriter* ‘the_writer’ originating from the RTPS *Reader* represented by the *ReaderProxy* ‘the_reader_proxy.’

The transition performs the same logical actions as Transition T8 (Section 8.4.9.2.8).

8.4.9.2.11 Transition T11

This transition is triggered by the firing of a timer indicating that the duration of W::nackResponseDelay has elapsed since the state **must_repair** was entered.

The transition performs no logical actions in the virtual machine.

8.4.9.2.12 Transition T12

This transition is triggered by the guard condition [RP::can_send() == true] indicating that the RTPS *Writer* ‘the_rtps_writer’ has the resources needed to send a change to the RTPS *Reader* represented by the *ReaderProxy* ‘the_reader_proxy.’

The transition performs the following logical actions in the virtual machine:

```
a_change := the_reader_proxy.next_requested_change();
a_change.status := UNDERWAY;
if (a_change.is_relevant) {
    DATA = new DATA(a_change, the_reader_proxy.remoteReaderGuid);
    IF (the_reader_proxy.expectsInlineQos) {
        DATA.inlineQos := the_rtps_writer.related_dds_writer.qos;
    }
    send DATA;
}
else {
    GAP = new GAP(a_change.sequenceNumber, the_reader_proxy.remoteReaderGuid);
    send GAP;
}
```

The above logic is not meant to imply that each DATA or GAP Submessage is sent in a separate RTPS message. Rather multiple Submessages can be combined into a single RTPS message.

The above illustrates the simplified case where a GAP Submessage includes a single sequence number. This would result in potentially many Submessages in cases where many sequence numbers in close proximity refer to changes that are not relevant to the Reader. Efficient implementations will combine multiple ‘irrelevant’ sequence numbers as much as possible into a single GAP message.

After the transition the following post-condition holds:

```
( a_change BELONGS-TO the_reader_proxy.requested_changes() ) == FALSE
```

8.4.9.2.13 Transition T13

This transition is triggered by the guard condition [RP::requested_changes() == <empty>] indicating that there are no more changes requested by the RTPS *Reader* represented by the *ReaderProxy*.

The transition performs no logical actions in the virtual machine.

8.4.9.2.14 Transition T14

This transition is triggered by the addition of a new *CacheChange* ‘a_change’ to the *HistoryCache* of the RTPS *Writer* ‘the_rtps_writer’ by the corresponding DDS DataWriter. Whether the change is relevant to the RTPS *Reader* represented by the *ReaderProxy* ‘the_reader_proxy’ is determined by the DDS_FILTER.

The transition performs the following logical actions in the virtual machine:

```
ADD a_change TO the_reader_proxy.changes_for_reader;
IF (DDS_FILTER(the_reader_proxy, change)) THEN a_change.is_relevant := FALSE;
ELSE a_change.is_relevant := TRUE;
IF (the_rtps_writer.pushMode == true) THEN a_change.status := UNSENT;
ELSE a_change.status := UNACKNOWLEDGED;
```

8.4.9.2.15 Transition T15

This transition is triggered by the removal of a *CacheChange* ‘a_change’ from the *HistoryCache* of the RTPS *Writer* ‘the_rtps_writer’ by the corresponding DDS DataWriter. For example, when using HISTORY QoS set to KEEP_LAST with depth == 1, a new change will cause the DDS DataWriter to remove the previous change from the *HistoryCache*.

The transition performs the following logical actions in the virtual machine:

```
a_change.is_relevant := FALSE;
```

8.4.9.2.16 Transition T16

This transition is triggered by the configuration of an RTPS *Writer* ‘the_rtps_writer’ to no longer be matched with the RTPS *Reader* represented by the *ReaderProxy* ‘the_reader_proxy.’ This configuration is done by the Discovery protocol (Section 8.5) as a consequence of breaking a pre-existing match of a DDS DataReader with the DDS DataWriter related to ‘the_rtps_writer.’

The transition performs the following logical actions in the virtual machine:

```
the_rtps_writer.matched_reader_remove(the_reader_proxy);
delete the_reader_proxy;
```

8.4.9.3 ChangeForReader illustrated

The *ChangeForReader* keeps track of the communication status (attribute *status*) and relevance (attribute *is_relevant*) of each *CacheChange* with respect to a specific remote RTPS *Reader*, identified by the corresponding *ReaderProxy*.

The attribute *is_relevant* is initialized to TRUE or FALSE when the *ChangeForReader* is created, depending on the DDS QoS and Filters that may apply. A *ChangeForReader* that initially has *is_relevant* set to TRUE may have the setting modified to FALSE when the corresponding *CacheChange* has become irrelevant for the RTPS *Reader* because of a later *CacheChange*. This can happen, for example, when the DDS QoS of the related DDS DataWriter specifies a HISTORY kind KEEP_LAST and a later *CacheChange* modifies the value of the same data-object (identified by the instanceHandle attribute of the *CacheChange*) making the previous *CacheChange* irrelevant.

The behavior of the RTPS *StatefulWriter* described in Figure 8.20 and Figure 8.21 modifies each *ChangeForReader* as a side-effect of the operation of the protocol. To further define the protocol, it is illustrative to examine the Finite State Machine representing the value of the *status* attribute for any given *ChangeForReader*. This is shown in Figure 8.22 below for a Reliable *StatefulWriter*. A Best-Effort *StatefulWriter* uses only a subset of the state-diagram.

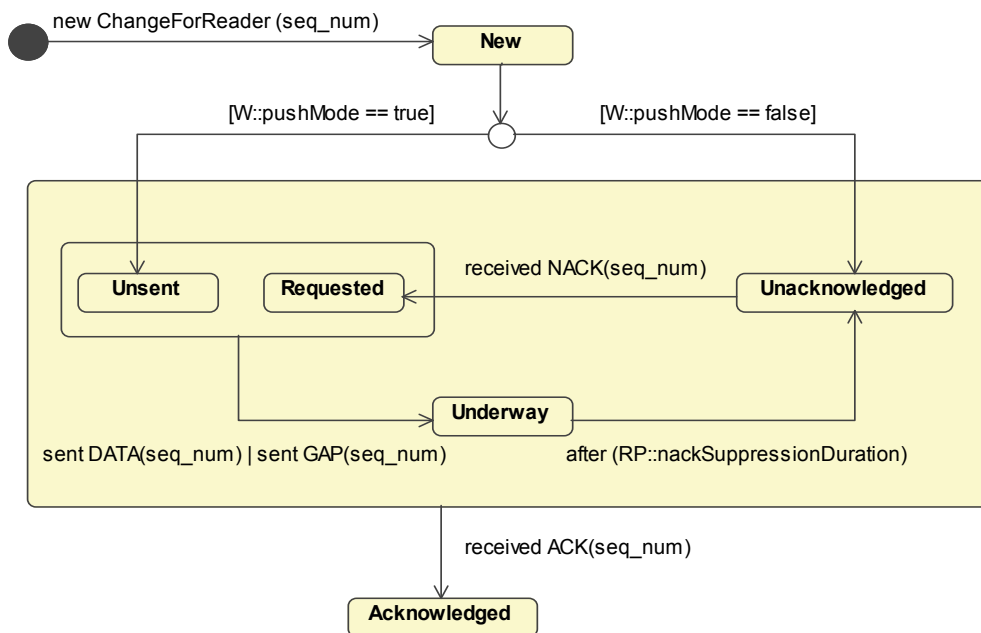

Figure 8.20 - Changes in the value of the status attribute of each ChangeForReader

The states have the following meanings:

- <New> a *CacheChange* with *SequenceNumber_t* 'seq_num' is available in the *HistoryCache* of the RTPS *StatefulWriter* but this has not been announced yet or sent to the RTPS *Reader* represented by the *ReaderProxy*.
- <Unsent> the *StatefulWriter* has never sent a DATA or GAP with this seq_num to the RTPS *Reader* and it intends to do so in the future.
- <Requested> the RTPS *Reader* has requested via an ACKNACK message that the change is sent again. The *StatefulWriter* intends to send the change again in the future.
- <Underway> the *CacheChange* has been sent and the *StatefulWriter* will ignore new requests for this *CacheChange*.
- <Unacknowledged> the *CacheChange* should be received by the RTPS *Reader*, but this has not been acknowledged by the RTPS *Reader*. As the message could have been lost, the RTPS *Reader* may request the *CacheChange* to be sent again.
- <Acknowledged> the RTPS *StatefulWriter* knows that the RTPS *Reader* has received the *CacheChange* with *SequenceNumber_t* 'seq_num.'

The following describes the main events that trigger transitions in the State Machine. Note that this state-machine just keeps track of the 'status' attribute of a particular *ChangeForReader* and does not perform any specific actions nor send any messages.

- new ChangeForReader (seq_num): The *ReaderProxy* has created a *ChangeForReader* association class to track the state of a *CacheChange* with *SequenceNumber_t* seq_num.

- [W::pushMode == true]: The setting of the *StatefulWriter*'s attribute W::pushMode determines whether the status is changed to <Unsent> or else is changed to <Unacknowledged>. A Best-Effort *Writer* always uses W::pushMode == true.
- received NACK(seq_num): The *StatefulWriter* has received an ACKNACK message where seq_num belongs to the ACKNACK.readerSNState, indicating the RTPS *Reader* has not received the *CacheChange* and wants the *StatefulWriter* to send it again.
- sent DATA(seq_num) : The *StatefulWriter* has sent a DATA message containing the *CacheChange* with *SequenceNumber_t* seq_num.
- sent GAP(seq_num) : The *StatefulWriter* has sent a GAP where seq_num is in the GAP's irrelevant_sequence_number_list, which means that the seq_num is irrelevant to the RTPS *Reader*.
- received ACK(seq_num) : The *Writer* has received an ACKNACK with ACKNACK.readerSNState.base > seq_num. This means the *CacheChange* with sequence number seq_num has been received by the RTPS *Reader*.

8.4.10 RTPS Reader Reference Implementations

The RTPS *Reader* Reference Implementations are based on specializations of the RTPS *Reader* class, first introduced in Section 8.2. This section describes the RTPS *Reader* and all additional classes used to model the RTPS *Reader* Reference Implementations. The actual behavior is described in Section 8.4.11 and Section 8.4.12.

8.4.10.1 RTPS Reader

RTPS *Reader* specializes RTPS *Endpoint* and represents the actor that receives *CacheChange* messages from one or more RTPS *Writer* endpoints. The Reference Implementations *StatelessReader* and *StatefulReader* specialize RTPS *Reader* and differ in the knowledge they maintain about the matched *Writer* endpoints.

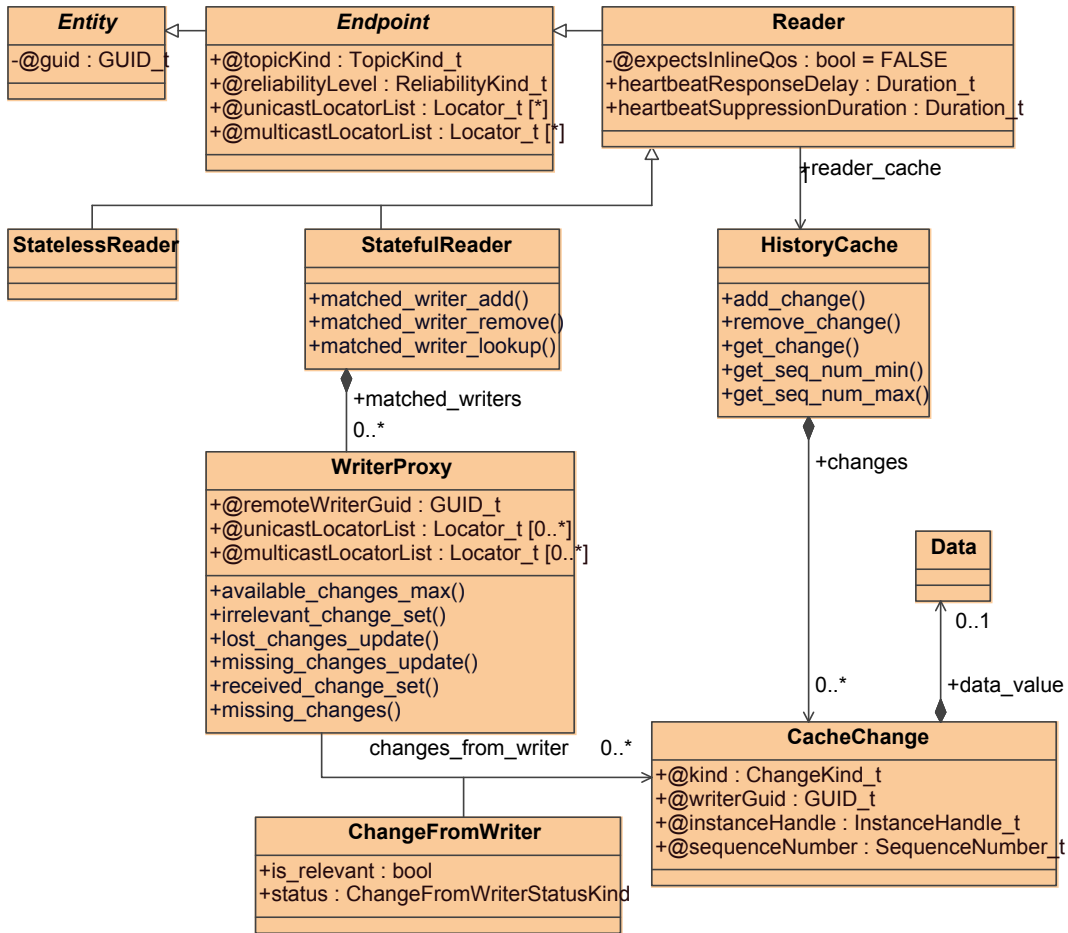

Figure 8.21 - RTPS Reader endpoints

The configuration attributes of the RTPS *Reader* are listed in Table 8.61 and allow for fine-tuning of the protocol behavior. The operations on an RTPS *Reader* are listed in Table 8.62.

Table 8.66 - RTPS Reader configuration attributes

RTPS Reader : RTPS Endpoint			
attribute	type	meaning	relation to DDS
heartbeatResponseDelay	Duration_t	Protocol tuning parameter that allows the RTPS <i>Reader</i> to delay the sending of a positive or negative acknowledgment (see Section 8.4.12.2)	N/A
heartbeatSuppressionDuration	Duration_t	Protocol tuning parameter that allows the RTPS <i>Reader</i> to ignore HEARTBEATs that arrive ‘too soon’ after a previous HEARTBEAT was received.	N/A
reader_cache	History Cache	Contains the history of CacheChange changes for this RTPS <i>Reader</i> .	N/A
expectsInlineQos	bool	Specifies whether the RTPS Reader expects in-line QoS to be sent along with any data.	

Table 8.67 - RTPS Reader operations

RTPS Reader operations		
<i>operation name</i>	<i>parameter list</i>	<i>type</i>
new	<return value>	Reader
	attribute_values	Set of attribute values required by the Reader and all the super classes.

The following sections provide details on the operations.

8.4.10.1.1 Default Timing-Related Values

The following timing-related values are used as the defaults in order to facilitate ‘out-of-the-box’ interoperability between implementations.

heartbeatResponseDelay.sec = 0;

heartbeatResponseDelay.nanosec = 500 * 1000 * 1000; // 500 milliseconds

heartbeatSuppressionDuration.sec = 0;

heartbeatSuppressionDuration.nanosec = 0;

8.4.10.1.2 new

This operation creates a new RTPS *Reader*.

The newly-created reader ‘this’ is initialized as follows:

```

this.guid := <as specified in the constructor>;
this.unicastLocatorList := <as specified in the constructor>;
this.multicastLocatorList := <as specified in the constructor>;
this.reliabilityLevel := <as specified in the constructor>;
this.topicKind := <as specified in the constructor>;
this.expectsInlineQos := <as specified in the constructor>;
this.heartbeatResponseDelay := <as specified in the constructor>;
this.reader_cache := new HistoryCache;

```

8.4.10.2 RTPS StatelessReader

Specialization of RTPS *Reader*. The RTPS *StatelessReader* has no knowledge of the number of matched writers, nor does it maintain any state for each matched RTPS *Writer*.

In the current Reference Implementation, the *StatelessReader* does not add any configuration attributes or operations to those inherited from the *Reader* super class. Both classes are therefore identical. The virtual machine interacts with the *StatelessReader* using the operations in Table 8.63.

Table 8.68 - StatelessReader operations

StatelessReader operations		
<i>operation name</i>	<i>parameter list</i>	<i>parameter type</i>
new	<return value>	StatelessReader
	attribute_values	Set of attribute values required by the StatelessReader and all the super classes.

8.4.10.2.1 new

This operation creates a new RTPS *StatelessReader*. The initialization is performed as on the RTPS *Reader* super class (Section 8.4.10.1.2).

8.4.10.3 RTPS StatefulReader

Specialization of RTPS *Reader*. The RTPS *StatefulReader* keeps state on each matched RTPS *Writer*. The state kept on each writer is encapsulated in the RTPS *WriterProxy* class.

Table 8.69 - RTPS StatefulReader Attributes

RTPS StatefulReader : RTPS Reader			
attribute	type	meaning	relation to DDS
matched_writers	WriteProxy[*]	Used to maintain state on the remote Writers matched up with the Reader.	N/A

The virtual machine interacts with the *StatefulReader* using the operations in Table 8.65.

Table 8.70 - StatefulReader Operations

StatefulReader operations		
<i>operation name</i>	<i>parameter list</i>	<i>parameter type</i>
new	<return value>	StatefulReader
	attribute_values	Set of attribute values required by the StatefulReader and all the super classes.
matched_writer_add	<return value>	void
	a_writer_proxy	WriterProxy
matched_writer_remove	<return value>	void
	a_writer_proxy	WriterProxy
matched_writer_lookup	<return value>	WriterProxy
	a_writer_guid	GUID_t

8.4.10.3.1 new

This operation creates a new RTPS *StatefulReader*. The newly-created stateful reader ‘this’ is initialized as follows:

```
this.attributes := <as specified in the constructor>;
this.matched_writers := <empty>;
```

8.4.10.3.2 matched_writer_add

This operation adds the *WriterProxy* *a_writer_proxy* to the StatefulReader::matched_writers.

```
ADD a_writer_proxy TO {this.matched_writers};
```

8.4.10.3.3 matched_writer_remove

This operation removes the *WriterProxy* *a_writer_proxy* from the set StatefulReader::matched_writers.

```
REMOVE a_writer_proxy FROM {this.matched_writers};
delete a_writer_proxy;
```

8.4.10.3.4 matched_writer_lookup

This operation finds the *WriterProxy* with GUID_t *a_writer_guid* from the set StatefulReader::matched_writers.

```
FIND proxy IN this.matched_writers SUCH-THAT (proxy.remoteWriterGuid == a_writer_guid);
return proxy;
```

8.4.10.4 RTPS WriterProxy

The RTPS *WriterProxy* represents the information an RTPS *StatefulReader* maintains on each matched RTPS *Writer*. The attributes of the RTPS *WriterProxy* are described in Table 8.66.

The association is a consequence of the matching of the corresponding DDS Entities as defined by the DDS specification, that is the DDS DataReader matching a DDS DataWriter by Topic, having compatible QoS, belonging to a common partition, and not being explicitly ignored by the application that uses DDS.

Table 8.71 - RTPS WriterProxy Attributes

RTPS WriterProxy			
attribute	type	meaning	relation to DDS
remoteWriterGuid	GUID_t	Identifies the matched Writer.	N/A. Configured by discovery
unicastLocatorList	Locator_t[*]	List of unicast (address, port) combinations that can be used to send messages to the matched Writer or Writers. The list may be empty.	N/A. Configured by discovery
multicastLocatorList	Locator_t[*]	List of multicast (address, port) combinations that can be used to send messages to the matched Writer or Writers. The list may be empty.	N/A. Configured by discovery
changes_from_writer	CacheChange[*]	List of <i>CacheChange</i> changes received or expected from the matched RTPS <i>Writer</i> .	N/A. Used to implement the behavior of the RTPS protocol.

The virtual machine interacts with the *WriterProxy* using the operations in Table 8.67.

Table 8.72 - WriterProxy Operations

WriterProxy operations		
<i>operation name</i>	<i>parameter list</i>	<i>parameter type</i>
new	<return value>	WriterProxy
	attribute_values	Set of attribute values required by the WriterProxy.
available_changes_max	<return value>	SequenceNumber_t
irrelevant_change_set	<return value>	void
	a_seq_num	SequenceNumber_t
lost_changes_update	<return value>	void
	first_available_seq_num	SequenceNumber_t
missing_changes	<return value>	SequenceNumber_t[]
missing_changes_update	<return value>	void

Table 8.72 - WriterProxy Operations

WriterProxy operations		
<i>operation name</i>	<i>parameter list</i>	<i>parameter type</i>
	last_available_seq_num	SequenceNumber_t
received_change_set	<return value>	void
	a_seq_num	SequenceNumber_t

8.4.10.4.1 new

This operation creates a new RTPS *WriterProxy*.

The newly-created writer proxy ‘this’ is initialized as follows:

```

this.attributes := <as specified in the constructor>;
this.changes_from_writer := <all past and future samples from the writer>;

```

The *changes_from_writer* of the newly-created *WriterProxy* is initialized to contain all past and future samples from the *Writer* represented by the *WriterProxy*. This is a conceptual representation only, used to describe the Stateful Reference Implementation. The *ChangeFromWriter* status of each *CacheChange* in *changes_from_writer* is initialized to UNKNOWN, indicating the StatefulReader initially does not know whether any of these changes actually already exist. As discussed in Section 8.4.12.3, the status will change to RECEIVED or MISSING as the StatefulReader receives the actual changes or is informed about their existence via a HEARTBEAT message.

8.4.10.4.2 available_changes_max

This operation returns the maximum *SequenceNumber_t* among the *changes_from_writer* changes in the RTPS *WriterProxy* that are available for access by the DDS *DataReader*.

The condition to make any *CacheChange* ‘a_change’ available for ‘access’ by the DDS *DataReader* is that there are no changes from the RTPS *Writer* with *SequenceNumber_t* smaller than or equal to a_change.sequenceNumber that have status MISSING or UNKNOWN. In other words, the available_changes_max and all previous changes are either RECEIVED or LOST.

Logical action in the virtual machine:

```

seq_num := MAX { change.sequenceNumber SUCH-THAT
    ( change IN this.changes_from_writer
      AND ( change.status == RECEIVED
          OR change.status == LOST) ) };
return seq_num;

```

8.4.10.4.3 irrelevant_change_set

This operation modifies the status of a *ChangeFromWriter* to indicate that the *CacheChange* with the *SequenceNumber_t* ‘a_seq_num’ is irrelevant to the RTPS *Reader*.

Logical action in the virtual machine:

```

FIND change FROM this.changes_from_writer SUCH-THAT
                                     (change.sequenceNumber == a_seq_num);
change.status := RECEIVED;
change.is_relevant := FALSE;

```

8.4.10.4.4 lost_changes_update

This operation modifies the status stored in *ChangeFromWriter* for any changes in the *WriterProxy* whose status is MISSING or UNKNOWN and have sequence numbers lower than ‘first_available_seq_num.’ The status of those changes is modified to LOST indicating that the changes are no longer available in the *WriterHistoryCache* of the RTPS *Writer* represented by the RTPS *WriterProxy*.

Logical action in the virtual machine:

```

FOREACH change IN this.changes_from_writer
  SUCH-THAT ( change.status == UNKNOWN OR change.status == MISSING
             AND seq_num < first_available_seq_num ) DO {
  change.status := LOST;
}

```

8.4.10.4.5 missing_changes

This operation returns the subset of changes for the *WriterProxy* that have status ‘MISSING.’ The changes with status ‘MISSING’ represent the set of changes available in the *HistoryCache* of the RTPS *Writer* represented by the RTPS *WriterProxy* that have not been received by the RTPS *Reader*.

```

return { change IN this.changes_from_writer SUCH-THAT change.status == MISSING };

```

8.4.10.4.6 missing_changes_update

This operation modifies the status stored in *ChangeFromWriter* for any changes in the *WriterProxy* whose status is UNKNOWN and have sequence numbers smaller or equal to ‘last_available_seq_num.’ The status of those changes is modified from UNKNOWN to MISSING indicating that the changes are available at the *WriterHistoryCache* of the RTPS *Writer* represented by the RTPS *WriterProxy* but have not been received by the RTPS *Reader*.

Logical action in the virtual machine:

```

FOREACH change IN this.changes_from_writer
  SUCH-THAT ( change.status == UNKNOWN
             AND seq_num <= last_available_seq_num ) DO {
  change.status := MISSING;
}

```

8.4.10.4.7 received_change_set

This operation modifies the status of the *ChangeFromWriter* that refers to the *CacheChange* with the *SequenceNumber_t* ‘a_seq_num.’ The status of the change is set to ‘RECEIVED,’ indicating it has been received.

Logical action in the virtual machine:

```

FIND change FROM this.changes_from_writer SUCH-THAT change.sequenceNumber == a_seq_num;
change.status := RECEIVED

```

8.4.10.5 RTPS ChangeFromWriter

The RTPS *ChangeFromWriter* is an association class that maintains information of a *CacheChange* in the RTPS *ReaderHistoryCache* as it pertains to the RTPS *Writer* represented by the *WriterProxy*.

The attributes of the RTPS *ChangeFromWriter* are described in Table 8.68.

Table 8.73 - RTPS ChangeFromWriter Attributes

RTPS ReaderProxy			
attribute	type	meaning	relation to DDS
status	ChangeFromWriter StatusKind	Indicates the status of a CacheChange relative to the RTPS Writer represented by the WriterProxy.	N/A. Used by the protocol.
is_relevant	bool	Indicates whether the change is relevant to the RTPS Reader.	The determination of irrelevant changes is affected by DDS DataReader TIME_BASED_FILTER QoS and also by the use of DDS ContentFilteredTopics.

8.4.11 RTPS StatelessReader Behavior

8.4.11.1 Best-Effort StatelessReader Behavior

The behavior of the WITH_KEY Best-Effort RTPS *StatelessReader* is independent of any writers and is described in Figure 8.22.

The behavior of a NO_KEY Best-Effort RTPS *StatelessReader* is identical ~~except that the Reader receives NoKeyData-Submessages instead of Data-Submessages.~~

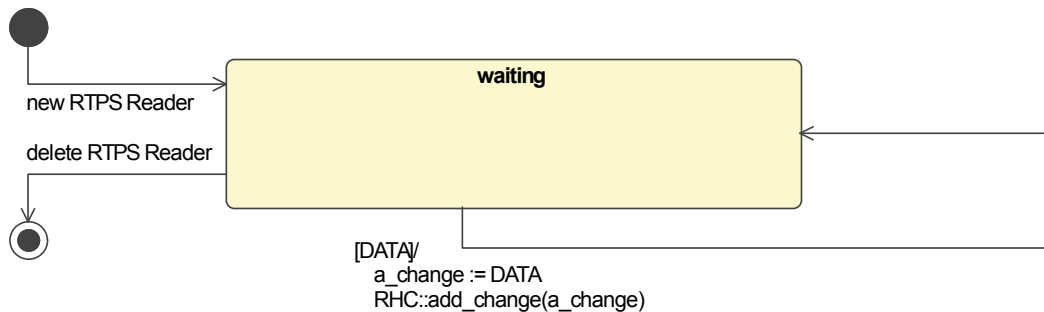

Figure 8.22 - Behavior of the WITH_KEY Best-Effort StatelessReader

The state-machine transitions are listed in Table 8.69.

Table 8.74 - Transitions for Best-effort StatelessReader behavior

Transition	state	event	next state
T1	initial	RTPS Reader is created	waiting
T2	waiting	DATA message is received	waiting
T3	waiting	RTPS Reader is deleted	final

8.4.11.1.1 Transition T1

This transition is triggered by the creation of an RTPS *StatelessReader* ‘the_rtps_reader.’ This is the result of the creation of a DDS DataReader as described in Section 8.2.9.

The transition performs no logical actions in the virtual machine.

8.4.11.1.2 Transition T2

This transition is triggered by the reception of a DATA message by the RTPS *Reader* ‘the_rtps_reader.’ The DATA message encapsulates the change ‘a_change.’ The encapsulation is described in Section 8.3.7.2.

The stateless nature of the *StatelessReader* prevents it from maintaining the information required to determine the highest sequence number received so far from the originating RTPS *Writer*. The consequence is that in those cases the corresponding DDS DataReader may be presented duplicate or out-of order changes. Note that if the DDS DataReader is configured to order data by ‘source timestamp,’ any available data will still be presented in-order when accessing the data through the DDS DataReader.

As mentioned in Section 8.4.3, actual stateless implementations may try to avoid this limitation and maintain this information in non-permanent fashion (using for example a cache that expires information after a certain time) to approximate, to the extent possible, the behavior that would result if the state were maintained.

The transition performs the following logical actions in the virtual machine:

```
a_change := new CacheChange(DATA);
the_rtps_reader.reader_cache.add_change(a_change);
```

8.4.11.1.3 Transition T3

This transition is triggered by the destruction of an RTPS *Reader* ‘the_rtps_reader.’ This is the result of the destruction of a DDS DataReader as described in Section 8.2.9.

The transition performs no logical actions in the virtual machine.

8.4.11.2 Reliable StatelessReader Behavior

This combination is not supported by the RTPS protocol. In order to implement the reliable protocol, the RTPS *Reader* must keep some state on each matched RTPS *Writer*.

8.4.12 RTPS StatefulReader Behavior

8.4.12.1 Best-Effort StatefulReader Behavior

The behavior of the WITH_KEY Best-Effort RTPS *StatefulReader* with respect to each matched *Writer* is described in Figure 8.23.

The behavior of a NO_KEY Best-Effort RTPS *StatefulReader* is identical ~~except that the *Reader* receives NoKeyData-Submessages instead of Data-Submessages.~~

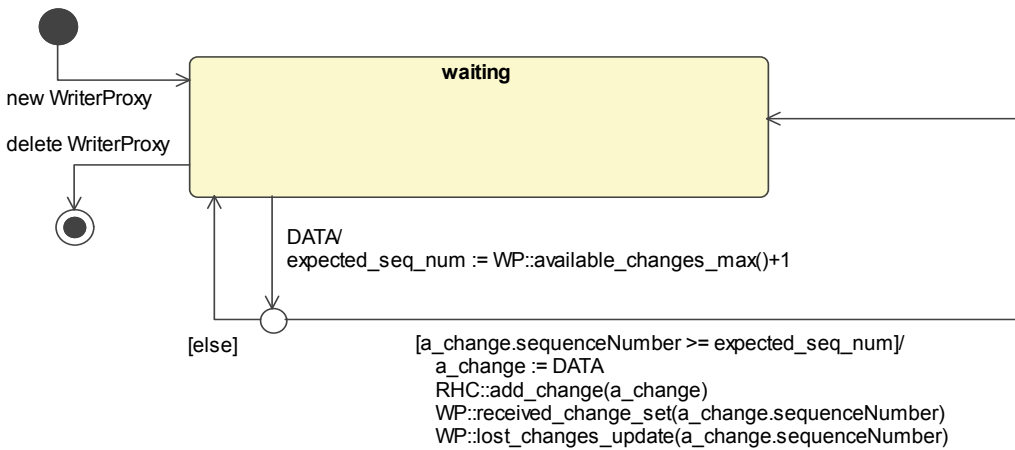

Figure 8.23 - Behavior of the WITH_KEY Best-Effort StatefulReader with respect to each matched Writer

The state-machine transitions are listed in Table 8.70.

Table 8.75 - Transitions for Best-Effort StatefulReader behavior with respect to each matched writer

Transition	state	event	next state
T1	initial	RTPS Reader is configured with a matched RTPS Writer	waiting
T2	waiting	DATA message is received from the matched Writer	waiting
T3	waiting	RTPS Reader is configured to no longer be matched with the RTPS Writer	final

8.4.12.1.1 Transition T1

This transition is triggered by the configuration of an RTPS *Reader* ‘the_rtps_reader’ with a matching RTPS *Writer*. This configuration is done by the Discovery protocol (Section 8.5) as a consequence of the discovery of a DDS DataWriter that matches the DDS DataReader that is related to ‘the_rtps_reader.’

The discovery protocol supplies the values for the *WriterProxy* constructor parameters.

The transition performs the following logical actions in the virtual machine:

```

a_writer_proxy := new WriterProxy(remoteWriterGuid,
                                unicastLocatorList,
                                multicastLocatorList);
the_rtps_reader.matched_writer_add(a_writer_proxy);

```

The *WriterProxy* is initialized with all past and future samples from the *Writer* as discussed in Section 8.4.10.4.

8.4.12.1.2 Transition T2

This transition is triggered by the reception of a DATA message by the RTPS *Reader* ‘the_rtps_reader.’ The DATA message encapsulates the change ‘a_change.’ The encapsulation is described in Section 8.3.7.2.

The Best-Effort reader checks that the sequence number associated with the change is strictly greater than the highest sequence number of all changes received in the past from this RTPS *Writer* (WP::available_changes_max()). If this check fails, the RTPS *Reader* discards the change. This ensures that there are no duplicate changes and no out-of-order changes.

The transition performs the following logical actions in the virtual machine:

```

a_change := new CacheChange(DATA);
writer_guid := {Receiver.SourceGuidPrefix, DATA.writerId};
writer_proxy := the_rtps_reader.matched_writer_lookup(writer_guid);
expected_seq_num := writer_proxy.available_changes_max() + 1;
if ( a_change.sequenceNumber >= expected_seq_num ) {
    the_rtps_reader.reader_cache.add_change(a_change);
    writer_proxy.received_change_set(a_change.sequenceNumber);
    if ( a_change.sequenceNumber > expected_seq_num ) {
        writer_proxy.lost_changes_update(a_change.sequenceNumber);
    }
}
}

```

After the transition the following post-conditions hold:

```

writer_proxy.available_changes_max() >= a_change.sequenceNumber

```

8.4.12.1.3 Transition T3

This transition is triggered by the configuration of an RTPS *Reader* ‘the_rtps_reader’ to no longer be matched with the RTPS *Writer* represented by the *WriterProxy* ‘the_writer_proxy.’ This configuration is done by the Discovery protocol (Section 8.5) as a consequence of breaking a pre-existing match of a DDS DataWriter with the DDS DataReader related to ‘the_rtps_reader.’

The transition performs the following logical actions in the virtual machine:

```

the_rtps_reader.matched_writer_remove(the_writer_proxy);
delete the_writer_proxy;

```

8.4.12.2 Reliable StatefulReader Behavior

The behavior of the WITH_KEY Reliable RTPS *StatefulReader* with respect to each matched RTPS *Writer* is described in Figure 8.24. The behavior of a NO_KEY Reliable RTPS *StatefulReader* is identical ~~except that the Reader receives NoKeyData-Submessages instead of Data-Submessages.~~

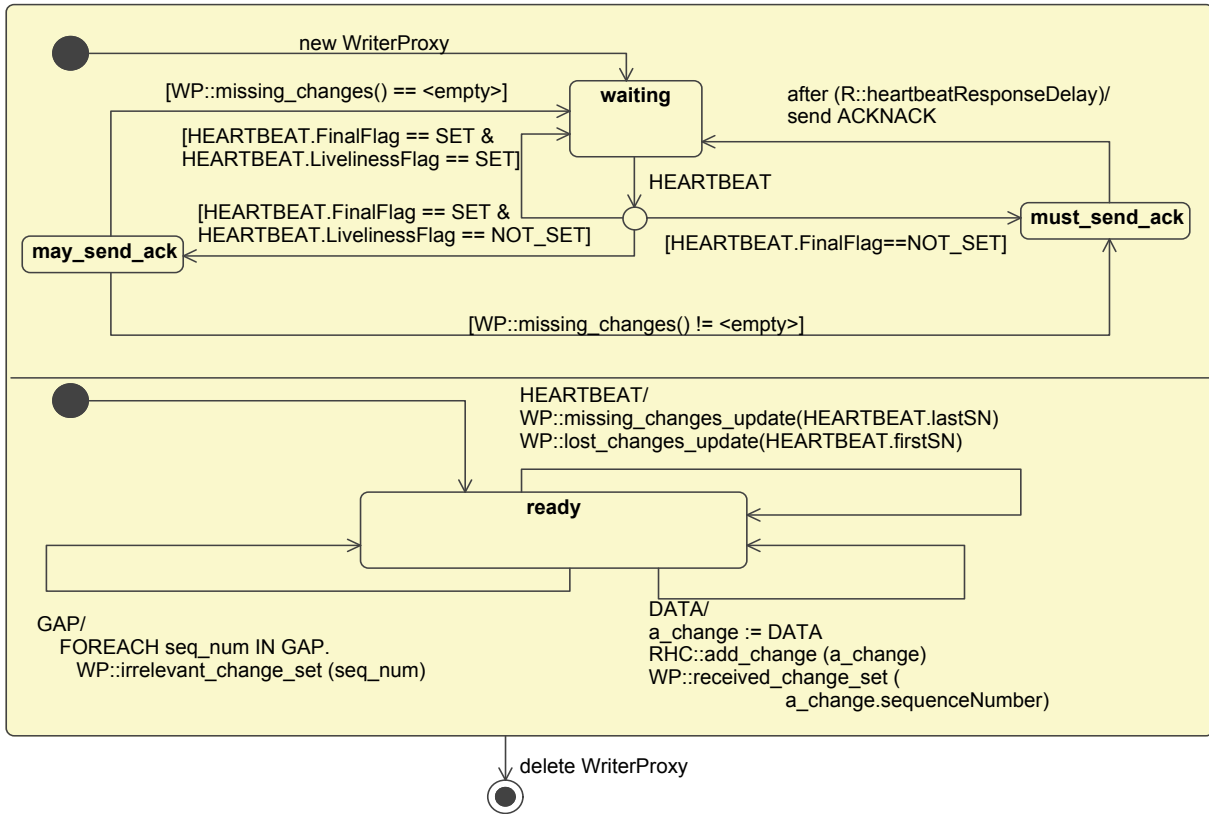

Figure 8.24 - Behavior of the Reliable StatefulReader with respect to each matched Writer

The state-machine transitions are listed in Table 8.71.

Table 8.76 - Transitions for Reliable reader behavior with respect to a matched writer

Transition	state	event	next state
T1	initial1	RTPS Reader is configured with a matched RTPS Writer.	waiting
T2	waiting	HEARTBEAT message is received.	if (HB.FinalFlag == NOT_SET) then must_send_ack else if (HB.LivelinessFlag == NOT_SET) then may_send_ack else waiting
T3	may_send_ack	GuardCondition: WP::missing_changes() == <empty>	waiting
T4	may_send_ack	GuardCondition: WP::missing_changes() != <empty>	must_send_ack

Table 8.76 - Transitions for Reliable reader behavior with respect to a matched writer

Transition	state	event	next state
T5	must_send_ack	after(R::heartbeatResponseDelay)	waiting
T6	initial2	RTPS Reader is configured with a matched RTPS Writer.	ready
T7	ready	HEARTBEAT message is received.	ready
T8	ready	DATA message is received.	ready
T9	ready	GAP message is received.	ready
T10	any state	RTPS Reader is configured to no longer be matched with the RTPS Writer.	final

8.4.12.2.1 Transition T1

This transition is triggered by the configuration of an RTPS Reliable *StatefulReader* ‘the_rtps_reader’ with a matching RTPS *Writer*. This configuration is done by the Discovery protocol (Section 8.5) as a consequence of the discovery of a DDS DataWriter that matches the DDS DataReader that is related to ‘the_rtps_reader.’

The discovery protocol supplies the values for the *WriterProxy* constructor parameters.

The transition performs the following logical actions in the virtual machine:

```
a_writer_proxy := new WriterProxy(remoteWriterGuid,
                                unicastLocatorList,
                                multicastLocatorList);
the_rtps_reader.matched_writer_add(a_writer_proxy);
```

The *WriterProxy* is initialized with all past and future samples from the *Writer* as discussed in Section 8.4.10.4.

8.4.12.2.2 Transition T2

This transition is triggered by the reception of a HEARTBEAT message destined to the RTPS *StatefulReader* ‘the_reader’ originating from the RTPS *Writer* represented by the *WriterProxy* ‘the_writer_proxy.’

The transition performs no logical actions in the virtual machine. Note however that the reception of a HEARTBEAT message causes the concurrent transition T7 (Section 8.4.12.2.7), which performs logical actions.

8.4.12.2.3 Transition T3

This transition is triggered by the guard condition [W::missing_changes() == <empty>] indicating that all changes known to be in the *HistoryCache* of the RTPS *Writer* represented by the *WriterProxy* have been received by the RTPS *Reader*.

The transition performs no logical actions in the virtual machine.

8.4.12.2.4 Transition T4

This transition is triggered by the guard condition [W::missing_changes() != <empty>] indicating that there are some changes known to be in the *HistoryCache* of the RTPS *Writer* represented by the *WriterProxy*, which have not been received by the RTPS *Reader*.

The transition performs no logical actions in the virtual machine.

8.4.12.2.5 Transition T5

This transition is triggered by the firing of a timer indicating that the duration of `R::heartbeatResponseDelay` has elapsed since the state `must_send_ack` was entered.

The transition performs the following logical actions for the *WriterProxy* ‘the_writer_proxy’ in the virtual machine:

```
missing_seq_num_set.base := the_writer_proxy.available_changes_max() + 1;
missing_seq_num_set.set := <empty>;
FOREACH change IN the_writer_proxy.missing_changes() DO
    ADD change.sequenceNumber TO missing_seq_num_set.set;
send ACKNACK(missing_seq_num_set);
```

The above logical action does not express the fact that the PSM mapping of the ACKNACK message will be limited in its capacity to contain sequence numbers. In the case where the ACKNACK message cannot accommodate the complete list of missing sequence numbers it should be constructed such that it contains the subset with smaller value of the sequence number.

8.4.12.2.6 Transition T6

Similar to T1 (Section 8.4.12.2.1) this transition is triggered by the configuration of an RTPS Reliable *StatefulReader* ‘the_rtps_reader’ with a matching RTPS *Writer*.

The transition performs no logical actions in the virtual machine.

8.4.12.2.7 Transition T7

This transition is triggered by the reception of a HEARTBEAT message destined to the RTPS *StatefulReader* ‘the_reader’ originating from the RTPS *Writer* represented by the *WriterProxy* ‘the_writer_proxy.’

The transition performs the following logical actions in the virtual machine:

```
the_writer_proxy.missing_changes_update(HEARTBEAT.lastSN);
the_writer_proxy.lost_changes_update(HEARTBEAT.firstSN);
```

8.4.12.2.8 Transition T8

This transition is triggered by the reception of a DATA message destined to the RTPS *StatefulReader* ‘the_reader’ originating from the RTPS *Writer* represented by the *WriterProxy* ‘the_writer_proxy.’

The transition performs the following logical actions in the virtual machine:

```
a_change := new CacheChange(DATA);
the_reader.reader_cache.add_change(a_change);
the_writer_proxy.received_change_set(a_change.sequenceNumber);
```

Any filtering is done when accessing the data using the DDS DataReader read or take operations, as described in Section 8.2.9.

8.4.12.2.9 Transition T9

This transition is triggered by the reception of a GAP message destined to the RTPS *StatefulReader* ‘the_reader’ originating from the RTPS *Writer* represented by the *WriterProxy* ‘the_writer_proxy.’

The transition performs the following logical actions in the virtual machine:

```

FOREACH seq_num IN [GAP.gapStart, GAP.gapList.base-1] DO {
    the_writer_proxy.irrelevant_change_set(seq_num);
}
FOREACH seq_num IN GAP.gapList DO {
    the_writer_proxy.irrelevant_change_set(seq_num);
}

```

8.4.12.2.10 Transition T10

This transition is triggered by the configuration of an RTPS *Reader* ‘the_rtps_reader’ to no longer be matched with the RTPS *Writer* represented by the *WriterProxy* ‘the_writer_proxy.’ This configuration is done by the Discovery protocol (Section 8.5) as a consequence of breaking a pre-existing match of a DDS DataWriter with the DDS DataReader related to ‘the_rtps_reader.’

The transition performs the following logical actions in the virtual machine:

```

the_rtps_reader.matched_writer_remove(the_writer_proxy);
delete the_writer_proxy;

```

8.4.12.3 ChangeFromWriter illustrated

The *ChangeFromWriter* keeps track of the communication status (attribute *status*) and relevance (attribute *is_relevant*) of each *CacheChange* with respect to a specific remote RTPS *Writer*.

The behavior of the RTPS *StatefulReader* described in Figure 8.24 modifies each *ChangeFromWriter* as a side-effect of the operation of the protocol. To further define the protocol it is illustrative to examine the State Machine representing the value of the *status* attribute for any given *ChangeFromWriter*. This is shown in Figure 8.25 for a Reliable *StatefulReader*. A Best-Effort *StatefulReader* uses only a subset of the state-diagram.

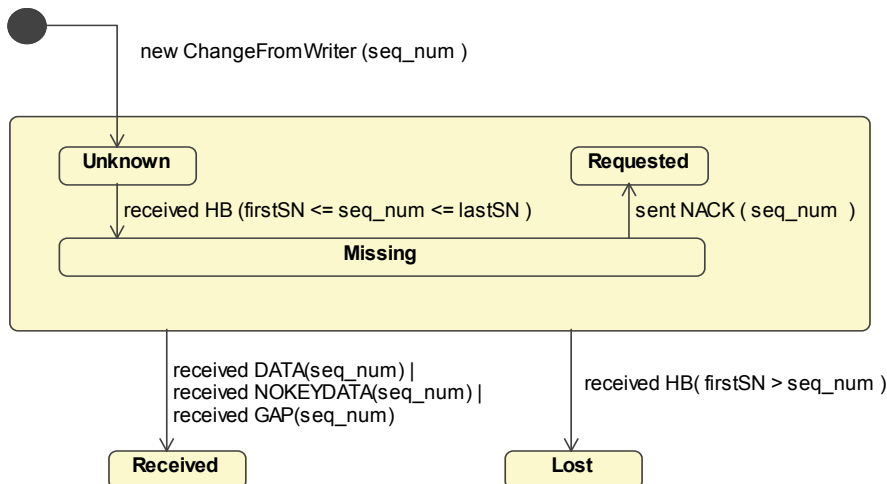

Figure 8.25 - Changes in the value of the status attribute of each *ChangeFromWriter*

The states have the following meanings:

- <Unknown> : A *CacheChange* with *SequenceNumber_t* seq_num may or may not be available yet at the RTPS *Writer*.
- <Missing>: The *CacheChange* with *SequenceNumber_t* seq_num is available in the RTPS *Writer* and has not been received yet by the RTPS *Reader*.
- <Requested>: The *CacheChange* with *SequenceNumber_t* seq_num was requested from the RTPS *Writer*, a response might be pending or underway.
- <Received> : The *CacheChange* with *SequenceNumber_t* seq_num was received: as a DATA if the seq_num is relevant to the RTPS *Reader* or as a GAP if the seq_num is irrelevant.
- <Lost> : The *CacheChange* with *SequenceNumber_t* seq_num is no longer available at the RTPS *Writer*. It will not be received.

The following describes the main events that trigger transitions in the State Machine. Note that this state-machine just keeps track of the ‘status’ attribute of a particular *ChangeForReader* and does not perform any specific actions nor send any messages.

- new ChangeFromWriter(seq_num): The *WriterProxy* has created a *ChangeFromWriter* association class to track the state of a *CacheChange* with *SequenceNumber_t* seq_num.
- received HB(firstSN <= seq_num <= lastSN): The *Reader* has received a HEARTBEAT with HEARTBEAT.firstSN <= seq_num <= HEARTBEAT.lastSN, indicating a *CacheChange* with that sequence number is available from the RTPS *Writer*.
- sent NACK(seq_num) : The *Reader* has sent an ACKNACK message containing the seq_num inside the ACKNACK.readerSNState, indicating the RTPS *Reader* has not received the *CacheChange* and is requesting it is sent again.
- received GAP(seq_num) : The *Reader* has received a GAP message where seq_num is inside GAP.gapList, which means that the seq_num is irrelevant to the RTPS *Reader*.
- received DATA(seq_num) : The *Reader* has received a DATA message with DATA.sequenceNumber == seq_num.
- ~~received NOKEYDATA(seq_num) : The *Reader* has received a NOKEYDATA message with NOKEYDATA.sequenceNumber == seq_num.~~
- received HB(firstSN > seq_num) : The *Reader* has received a HEARTBEAT with HEARTBEAT.firstSN > seq_num, indicating the *CacheChange* with that sequence number is no longer available from the RTPS *Writer*.

8.4.13 Writer Liveliness Protocol

The DDS specification requires the presence of a liveliness mechanism. RTPS realizes this requirement with the *Writer* Liveliness Protocol. The *Writer* Liveliness Protocol defines the required information exchange between two *Participants* in order to assert the liveliness of *Writers* contained by the *Participants*.

All implementations must support the Writer Liveliness Protocol in order to be interoperable.

8.4.13.1 General Approach

The *Writer* Liveliness Protocol uses pre-defined built-in Endpoints. The use of built-in Endpoints means that once a *Participant* knows of the presence of another *Participant*, it can assume the presence of the built-in Endpoints made available by the remote *Participant* and establish the association with the locally matching built-in Endpoints.

The protocol used to communicate between built-in Endpoints is the same as used for application-defined Endpoints.

8.4.13.2 Built-in Endpoints Required by the Writer Liveliness Protocol

The built-in Endpoints required by the *Writer* Liveliness Protocol are the *BuiltinParticipantMessageWriter* and *BuiltinParticipantMessageReader*. The names of these Endpoint reflect the fact that they are general-purpose. These Endpoints are used for liveliness but can be used for other data in the future.

The RTPS Protocol reserves the following values of the *EntityId_t* for these built-in Endpoints:

```
ENTITYID_P2P_BUILTIN_PARTICIPANT_MESSAGE_WRITER
ENTITYID_P2P_BUILTIN_PARTICIPANT_MESSAGE_READER
```

The actual value for each of these *EntityId_t* instances is defined by each PSM.

8.4.13.3 BuiltinParticipantMessageWriter and BuiltinParticipantMessageReader QoS

For interoperability, both the BuiltinParticipantMessageWriter and BuiltinParticipantMessageReader use the following QoS values:

- reliability.kind = RELIABLE_RELIABILITY_QOS
- durability.kind = TRANSIENT_LOCAL_DURABILITY
- history.kind = KEEP_LAST_HISTORY_QOS
- history.depth = 1

8.4.13.4 Data Types Associated with Built-in Endpoints used by Writer Liveliness Protocol

Each RTPS *Endpoint* has a *HistoryCache* that stores changes to the data-objects associated with the *Endpoint*. This is also true for the RTPS built-in *Endpoints*. Therefore, each RTPS built-in *Endpoint* depends on some DataType that represents the logical contents of the data written into its *HistoryCache*.

Figure 8.26 defines the *ParticipantMessageData* datatype associated with the RTPS built-in Endpoint for the DCPSParticipantMessage Topic.

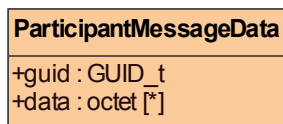

Figure 8.26 - ParticipantMessageData

8.4.13.5 Implementing Writer Liveliness Protocol Using the BuiltinParticipantMessageWriter and BuiltinParticipantMessageReader

The liveliness of a subset of *Writers* belonging to a *Participant* is asserted by writing a sample to the *BuiltinParticipantMessageWriter*. If the *Participant* contains one or more *Writers* with a liveliness of AUTOMATIC_LIVELINESS_QoS, then one sample is written at a rate faster than the smallest lease duration among the *Writers* sharing this QoS. Similarly, a separate sample is written if the *Participant* contains one or more *Writers* with a liveliness of MANUAL_BY_PARTICIPANT_LIVELINESS_QoS at a rate faster than the smallest lease duration among these *Writers*. The two instances are orthogonal in purpose so that if a *Participant* contains *Writers* of each of the two

liveliness kinds described, two separate instances must be periodically written. The instances are distinguished using their DDS key, which is comprised of the *participantGuidPrefix* and *kind* fields. Each of the two types of liveliness QoS handled through this protocol will result in a unique *kind* field and therefore form two distinct instances in the *HistoryCache*.

In both liveliness cases the *participantGuidPrefix* field contains the *GuidPrefix_t* of the *Participant* that is writing the data (and therefore asserting the liveliness of its *Writers*).

The DDS liveliness kind *MANUAL_BY_TOPIC_LIVELINESS_QOS* is not implemented using the *BuiltinParticipantMessageWriter* and *BuiltinParticipantMessageReader*. It is discussed in Section 8.7.2.2.3.

8.4.14 Optional Behavior

This section describes optional features of the RTPS protocol. Optional features may not be supported by all RTPS implementations. An optional feature does not affect basic interoperability, but is only available if all implementations involved support it.

8.4.14.1 Large Data

As described in Section 7.6, RTPS poses very few requirements on the underlying transport. It is sufficient that the transport offers a connectionless service capable of sending packets best-effort.

That said, a transport may impose its own limitations. For example, it may limit the maximum packet size (e.g., 64K for UDP) and hence the maximum RTPS Submessage size. This mainly affects the **Data and NoKeyData**-Submessages, as it limits the maximum size of the *serializedData* or also, the maximum serialized size of the data type used.

In order to address this limitation, Section 8.3.7 introduces the following Submessages to enable fragmenting large data:

- DataFrag
- ~~NoKeyDataFrag~~
- HeartbeatFrag
- NackFrag

The following sections list the corresponding behavior required for interoperability. ~~The behavior is identical for DataFrag and NoKeyDataFrag Submessages, so the discussion below only mentions the former.~~

8.4.14.1.1 How to select the fragment size

The fragment size is determined by the *Writer* and must meet the following requirements:

- All transports available to the *Writer* must be able to accommodate **DataFrag** Submessages containing at least one fragment. This means the transport with the smallest maximum message size determines the fragment size.
- The fragment size must be fixed for a given *Writer* and is identical for all remote *Readers*. By fixing the fragment size, the data a fragment number refers to does not depend on a particular remote *Reader*. This simplifies processing negative acknowledgements (**NackFrag**) from a *Reader*.
- The fragment size must satisfy $1\text{KB} < \text{fragment size} < 64\text{KB}$.

Note the fragment size is determined by *all* transports available to the *Writer*, not simply the subset of transports required to reach all currently known *Readers*. This ensures newly discovered *Readers*, regardless of the transport transport they can be reached on, can be accomodated without having to change the fragment size, which would violate the above requirements.

8.4.14.1.2 How to send fragments

If fragmentation is required, a **Data** Submessage is replaced by a sequence of **DataFrag** Submessages. The protocol behavior for sending **DataFrag** Submessages matches that for sending regular **Data** Submessages with the following additional requirements:

- **DataFrag** Submessages are sent in order, where ordering is defined by increasing fragment numbers. Note this does not guarantee in order arrival.
- Data must only be fragmented if required. If multiple transports are available to the *Writer* and some transports do not require fragmentation, a regular **Data** Submessage must be sent on those transports instead. Likewise, for variable size data types, a regular **Data** Submessage must be used if fragmentation is not required for a particular sequence number.
- For a given sequence number, if in-line QoS parameters are used, they must be included with the first **DataFrag** Submessage (containing the fragment with fragment number equal to 1). They may also be included with subsequent **DataFrag** submessages for this sequence number, but this is not required.

If a transport can accomodate multiple fragments of the given fragment size, it is recommended that implementations concatenate as many fragments as possible into a single **DataFrag** message.

When sending multiple **DataFrag** messages, flow control may be required to avoid flooding the network. Possible approaches include a leaky bucket or token bucket flow control scheme. This is not part of the RTPS specification.

8.4.14.1.3 How to re-assemble fragments

DataFrag Submessages contain all required information to re-assemble the serialized data. Once all fragments have been received, the same protocol behavior applies as for a regular **Data** Submessage.

Note that implementations must be able to handle out-of-order arrival of **DataFrag** submessages.

8.4.14.1.4 Reliable Communication

The protocol behavior for reliably sending **DataFrag** Submessages matches that for sending regular **Data** Submessages with the following additional requirements:

- The semantics for a **Heartbeat** Submessage remain unchanged: a **Heartbeat** message must only include those sequence numbers for which *all* fragments are available.
- The semantics for an **AckNack** Submessage remain unchanged: an **AckNack** message must only positively acknowledge a sequence number when all fragments were received for that sequence number. Likewise, a sequence number must be negatively acknowledged only when all fragments are missing.
- In order to negatively acknowledge a subset of fragments for a given sequence number, a **NackFrag** Submessage must be used. When data is fragmented, a **Heartbeat** may trigger both **AckNack** and **NackFrag** Submessages.

Additional considerations:

- As mentioned above, a **Heartbeat** Submessage can only include a sequence number once all fragments for that sequence number are available. If a **Writer** wants to inform a **Reader** on the partial availability of fragments for a given sequence number, a **HeartbeatFrag** Submessage can be used instead. Fragment level reliability may be helpful for very large data and when using flow control.
- A **NackFrag** Submessage can only be sent in response to a **Heartbeat** or **HeartbeatFrag** submessage.

8.4.15 Implementation Guidelines

The contents of this section are not part of the formal specification of the protocol. The purpose of this section is to provide guidelines for high-performance implementations of the protocol.

8.4.15.1 Implementation of ReaderProxy and WriterProxy

The PIM models the **ReaderProxy** as maintaining an association with each **CacheChange** in the **Writer's HistoryCache**. This association is modeled as being mediated by the association class **ChangeForReader**. The direct implementation of this model would result in a lot of information being maintained for each **ReaderProxy**. In practice, what is required is that the **ReaderProxy** is able to implement the operations used by the protocol and this does not require the use of explicit associations.

For example, the operations **unsent_changes()** and **next_unsent_change()** can be implemented by having the **ReaderProxy** maintain a single sequence number '*highestSeqNumSent*.' The *highestSeqNumSent* would record the highest value of the sequence number of any **CacheChange** sent to the **ReaderProxy**. Using this the operation **unsent_changes()** could be implemented by looking up all changes in the **HistoryCache** and selecting the ones with *sequenceNumber* greater than *highestSeqNumSent*. The implementation of **next_unsent_change()** would also look at the **HistoryCache** and return the **CacheChange** that has the next-highest sequence number greater than *highestSeqNumSent*. These operations could be done efficiently if the **HistoryCache** maintains an index by *sequenceNumber*.

The same techniques can be used to implement, **requested_changes()**, **requested_changes_set()**, and **next_requested_change()**. In this case, the implementation can maintain a sliding window of sequence numbers (which can be efficiently represented by a **SequenceNumber_t lowestRequestedChange** and a fixed-length bitmap) to store whether a particular sequence number is currently requested. Requests that do not fit in the window can be ignored as they correspond to sequence numbers higher than the ones in the window and the reader can be relied on re-sending the request later if it is still missing the change.

Similar techniques can be used to implement **acked_changes_set()** and **unacked_changes()**.

8.4.15.2 Efficient use of Gap and AckNack Submessages

Both **Gap** and **AckNack** Submessages are designed such that they can contain information about a set of sequence numbers. For simplicity, the virtual machine used in the protocol description did not always attempt to fully use these Submessages to store all the sequence numbers for which they would apply. The result would be that sometimes multiple **Gap** or **AckNack** messages would be sent when, a more efficient implementation, would have combined these Submessages into a single one. All these implementations are compliant with the protocol and interoperable. However, implementations that combine multiple **Gap** and **AckNack** Submessages and take advantage of the ability of these Submessages to contain a set of sequence number will be more efficient in both bandwidth and CPU usage.

8.4.15.3 Coalescing multiple Data Submessages

The RTPS protocol allows multiple Submessages to be coalesced into a single RTPS message. This means that they will all share a single RTPS Header and be sent in a single ‘network-transport transaction.’ Most network-transports have a relatively-large fixed overhead compared with the extra cost of additional bytes in the message. Therefore, implementations that combine Submessages into a single RTPS message will in general make better utilization of CPU and bandwidth.

A particularly common case is the coalescing of multiple **Data** Submessages into a single RTPS message. The need for this can occur in a response to an **AckNack** requesting multiple changes or as a result of multiple changes made on the writer side that have not yet been propagated to the reader. In all these cases, it is generally beneficial to coalesce the Submessages into fewer RTPS messages.

Note that the coalescing of **Data** Submessages is not restricted to Submessages originating from the same RTPS **Writer**. It is also possible to coalesce Submessages originating from multiple RTPS **Writer** entities. RTPS **Writer** entities that correspond to DDS DataWriter entities belonging to the same DDS Publisher are prime candidates for this.

8.4.15.4 Piggybacking HeartBeat Submessages

The RTPS protocol allows Submessages of different kinds to be coalesced into a single RTPS message. A particularly useful case is the piggybacking of **HeartBeat** Submessages following **Data** Submessages. This allows the RTPS **Writer** to explicitly request an acknowledgment of the changes it sent without the additional traffic needed to send a separate **HeartBeat**.

8.4.15.5 Sending to unknown readerId

As described in the Messages Module, it is possible to send RTPS Messages where the readerId is left unspecified (ENTITYID_UNKNOWN). This is required when sending these Messages over Multicast, but also allows to send a single Message over unicast to reach multiple **Readers** within the same **Participant**. Implementations are encouraged to use this feature to minimize bandwidth usage.

8.4.15.6 Reclaiming Finite Resources from Unresponsive Readers

An implementation likely has finite resources to work with. For a **Writer**, reclaiming queue resources should happen when all **Readers** have acknowledged a sample in the queue and resources limits dictate that the old sample entry is to be used for a new sample.

There may be scenarios where an alive **Reader** becomes unresponsive and will never acknowledge the **Writer**. Instead of blocking on the unresponsive **Reader**, the **Writer** should be allowed to deem the **Reader** as ‘Inactive’ and proceed in updating its queue. The state of a **Reader** is either Active or Inactive. Active **Readers** have sent ACKNACKs that have been recently received. The **Writer** should determine the inactivity of a **Reader** by using a mechanism based on the rate and number of ACKNACKs received. Then samples that have been acknowledged by all Active **Readers** can be freed, and the **Writer** can reclaim those resources if necessary. Note that strict reliability is not guaranteed when a **Reader** becomes Inactive.

8.4.15.7 Setting Count of Heartbeats and ACKNACKs

The Count element of a HEARTBEAT differentiate between logical HEARTBEATS. A received HEARTBEAT with the same Count as a previously received HEARTBEAT can be ignored to prevent triggering a duplicate repair session. So, an implementation should ensure that sample logical HEARTBEATS are tagged with the same Count.

New HEARTBEATS should have Counts greater than all older HEARTBEATS. Then, received HEARTBEATS with Counts not greater than any previously received can be ignored.

The same logic applies for Counts of ACKNACKs.

8.5 Discovery Module

The RTPS Behavior Module assumes RTPS Endpoints are properly configured and paired up with matching remote Endpoints. It does not make any assumptions on how this configuration took place and only defines how to exchange data between these Endpoints.

In order to be able to configure Endpoints, implementations must obtain information on the presence of remote Endpoints and their properties. How to obtain this information is the subject of the Discovery Module.

The Discovery Module defines the RTPS discovery protocol. The purpose of the discovery protocol is to allow each RTPS *Participant* to discover other relevant *Participants* and their *Endpoints*. Once remote Endpoints have been discovered, implementations can configure local Endpoints accordingly to establish communication.

The DDS specification equally relies on the use of a discovery mechanism to establish communication between matched DataWriters and DataReaders. DDS implementations must automatically discover the presence of remote entities, both when they join and leave the network. This discovery information is made accessible to the user through DDS built-in topics.

The RTPS discovery protocol defined in this Module provides the required discovery mechanism for DDS.

8.5.1 Overview

The RTPS specification splits up the discovery protocol into two independent protocols:

1. *Participant* Discovery Protocol
2. *Endpoint* Discovery Protocol

A *Participant* Discovery Protocol (PDP) specifies how *Participants* discover each other in the network. Once two *Participants* have discovered each other, they exchange information on the *Endpoints* they contain using an *Endpoint* Discovery Protocol (EDP). Apart from this causality relationship, both protocols can be considered independent.

Implementations may choose to support multiple PDPs and EDPs, possibly vendor-specific. As long as two *Participants* have at least one PDP and EDP in common, they can exchange the required discovery information. For the purpose of interoperability, all RTPS implementations must provide at least the following discovery protocols:

1. Simple Participant Discovery Protocol (SPDP)
2. Simple Endpoint Discovery Protocol (SEDP)

Both are basic discovery protocols that suffice for small to medium scale networks. Additional PDPs and EDPs that are geared towards larger networks may be added to future versions of the specification.

Finally, the role of a discovery protocol is to provide information on discovered remote *Endpoints*. How this information is used by a *Participant* to configure its local *Endpoints* depends on the actual implementation of the RTPS protocol and is not part of the discovery protocol specification. For example, for the reference implementations introduced in Section 8.4.7, the information obtained on the remote *Endpoints* allows the implementation to configure:

- The RTPS *ReaderLocator* objects that are associated with each RTPS *StatelessWriter*.
- The RTPS *ReaderProxy* objects associated with each RTPS *StatefulWriter*
- The RTPS *WriterProxy* objects associated with each RTPS *StatefulReader*

The Discovery Module is organized as follows:

- The SPDP and SEDP rely on pre-defined RTPS built-in Writer and Reader Endpoints to exchange discovery information. Section 8.5.2 introduces these RTPS built-in Endpoints.
- The SPDP is discussed in Section 8.5.3.
- The SEDP is discussed in Section 8.5.4.

8.5.2 RTPS built-in Discovery Endpoints

The DDS specification specifies that discovery takes place using “built-in” DDS *DataReaders* and *DataWriters* with pre-defined Topics and QoS.

There are four pre-defined built-in Topics: “DCPSParticipant,” “DCPSSubscription,” “DCPSPublication,” and “DCPSTopic.” The DataTypes associated with these Topics are also specified by the DDS specification and mainly contain Entity QoS values.

For each of the built-in Topics, there exists a corresponding DDS built-in DataWriter and DDS built-in DataReader. The built-in DataWriters are used to announce the presence and QoS of the local DDS Participant and the DDS Entities it contains (DataReaders, DataWriters and Topics) to the rest of the network. Likewise, the built-in DataReaders collect this information from remote Participants, which is then used by the DDS implementation to identify matching remote Entities. The built-in DataReaders act as regular DDS DataReaders and can also be accessed by the user through the DDS API.

The approach taken by the RTPS Simple Discovery Protocols (SPDP and SEDP) is analogous to the built-in Entity concept. RTPS maps each built-in DDS DataWriter or DataReader to an associated built-in RTPS *Endpoint*. These built-in Endpoints act as regular Writer and Reader Endpoints and provide the means to exchange the required discovery information between Participants using the regular RTPS protocol defined in the Behavior Module.

The SPDP, which concerns itself with how Participants discover each other, maps the DDS built-in Entities for the “DCPSParticipant” Topic. The SEDP, which specifies how to exchange discovery information on local Topics, DataWriters and DataReaders, maps the DDS built-in Entities for the “DCPSSubscription,” “DCPSPublication” and “DCPSTopic” Topics.

8.5.3 The Simple Participant Discovery Protocol

The purpose of a PDP is to discover the presence of other Participants on the network and their properties.

A Participant may support multiple PDPs, but for the purpose of interoperability, all implementations must support at least the Simple Participant Discovery Protocol.

8.5.3.1 General Approach

The RTPS Simple Participant Discovery Protocol (SPDP) uses a simple approach to announce and detect the presence of *Participants* in a domain.

For each **Participant**, the SPDP creates two RTPS built-in Endpoints: the *SPDPbuiltinParticipantWriter* and the *SPDPbuiltinParticipantReader*.

The *SPDPbuiltinParticipantWriter* is an RTPS Best-Effort **StatelessWriter**. The **HistoryCache** of the *SPDPbuiltinParticipantWriter* contains a single data-object of type **SPDPdiscoveredParticipantData**. The value of this data-object is set from the attributes in the **Participant**. If the attributes change, the data-object is replaced.

The *SPDPbuiltinParticipantWriter* periodically sends this data-object to a pre-configured list of locators to announce the Participant's presence on the network. This is achieved by periodically calling `StatelessWriter::unsent_changes_reset`, which causes the `StatelessWriter` to resend all changes present in its `HistoryCache` to all locators. The periodic rate at which the *SPDPbuiltinParticipantWriter* sends out the **SPDPdiscoveredParticipantData** defaults to a PSM specified value. This period should be smaller than the `leaseDuration` specified in the **SPDPdiscoveredParticipantData** (see also Section 8.5.3.3.2).

The pre-configured list of locators may include both unicast and multicast locators. Port numbers are defined by each PSM. These locators simply represent possible remote Participants in the network, no Participant need actually be present. By sending the **SPDPdiscoveredParticipantData** periodically, Participants can join the network in any order.

The *SPDPbuiltinParticipantReader* receives the **SPDPdiscoveredParticipantData** announcements from the remote Participants. The contained information includes what Endpoint Discovery Protocols the remote Participant supports. The proper Endpoint Discovery Protocol is then used for exchanging Endpoint information with the remote Participant.

Implementations can minimize any start-up delays by sending an additional **SPDPdiscoveredParticipantData** in response to receiving this data-object from a previously unknown Participant, but this behavior is optional. Implementations may also enable the user to choose whether to automatically extend the pre-configured list of locators with new locators from newly discovered Participants. This enables a-symmetric locator lists. These last two features are optional and not required for the purpose of interoperability.

8.5.3.2 SPDPdiscoveredParticipantData

The **SPDPdiscoveredParticipantData** defines the data exchanged as part of the SPDP.

Figure 8.27 illustrates the contents of the *SPDPdiscoveredParticipantData*. As shown in the figure, the *SPDPdiscoveredParticipantData* specializes the *ParticipantProxy* and therefore includes all the information necessary to configure a discovered *Participant*. The *SPDPdiscoveredParticipantData* also specializes the DDS-defined *DDS::ParticipantBuiltinTopicData* providing the information the corresponding DDS built-in *DataReader* needs.

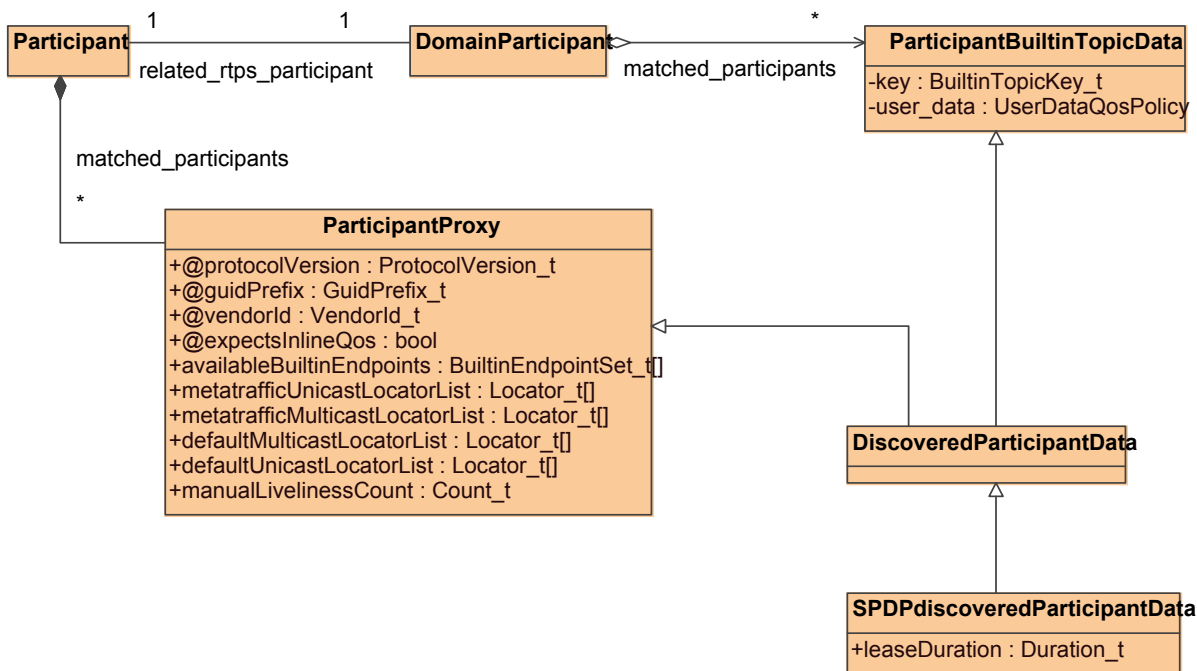

Figure 8.27 - *SPDPdiscoveredParticipantData*

The attributes of the *SPDPdiscoveredParticipantData* and their interpretation are described in Table 8.72.

Table 8.77 - RTPS *SPDPdiscoveredParticipantData* attributes

RTPS <i>SPDPdiscoveredParticipantData</i>		
attribute	type	meaning
protocolVersion	ProtocolVersion_t	Identifies the RTPS protocol version used by the Participant.
guidPrefix	GuidPrefix_t	The common GuidPrefix_t of the Participant and all the Endpoints contained within the Participant.
vendorId	VendorId_t	Identifies the vendor of the DDS middleware that contains the Participant.
expectsInlineQos	bool	Describes whether the Readers within the Participant expect that the QoS values that apply to each data modification are encapsulated with each Data and NoKeyData Submessage .

Table 8.77 - RTPS SPDPdiscoveredParticipantData attributes

RTPS SPDPdiscoveredParticipantData		
attribute	type	meaning
metatrafficUnicast LocatorList	Locator_t[*]	List of unicast locators (transport, address, port combinations) that can be used to send messages to the built-in Endpoints contained in the Participant.
metatrafficMulticast LocatorList	Locator_t[*]	List of multicast locators (transport, address, port combinations) that can be used to send messages to the built-in Endpoints contained in the Participant.
defaultUnicast LocatorList	Locator_t[1..*]	Default list of unicast locators (transport, address, port combinations) that can be used to send messages to the user-defined Endpoints contained in the Participant. These are the unicast locators that will be used in case the Endpoint does not specify its own set of Locators, so at least one Locator must be present.
defaultMulticast LocatorList	Locator_t[*]	Default list of multicast locators (transport, address, port combinations) that can be used to send messages to the user-defined Endpoints contained in the Participant. These are the multicast locators that will be used in case the Endpoint does not specify its own set of Locators.
availableBuiltin Endpoints	BuiltinEndpointSet_t[*]	All Participants must support the SEDP. This attribute identifies the kinds of built-in SEDP Endpoints that are available in the Participant. This allows a Participant to indicate that it only contains a subset of the possible built-in Endpoints. See also Section 8.5.4.3. Possible values for BuiltinEndpointSet_t are: PUBLICATIONS_READER, PUBLICATIONS_WRITER, SUBSCRIPTIONS_READER, SUBSCRIPTIONS_WRITER, TOPIC_READER, TOPIC_WRITER Vendor specific extensions may be used to denote support for additional EDPs.
leaseDuration	Duration_t	How long a Participant should be considered alive every time an announcement is received from the Participant. If a Participant fails to send another announcement within this time period, the Participant can be considered gone. In that case, any resources associated to the Participant and its Endpoints can be freed.
manualLivelinessCount	Count_t	Used to implement MANUAL_BY_PARTICIPANT liveliness QoS. When liveliness is asserted, the manualLivelinessCount is incremented and a new SPDPdiscoveredParticipantData is sent.

As mentioned in Section 8.5.3.1, the *SPDPdiscoveredParticipantData* lists the Endpoint Discovery Protocols supported by the *Participant*. The attributes shown in Table 8.72 only reflect the mandatory SEDP. There are currently no other Endpoint Discovery Protocols defined by the RTPS specification. In order to extend *SPDPdiscoveredParticipantData* to include additional EDPs, the standard RTPS extension mechanisms can be used. Please refer to Section 9.6.2 for additional information.

8.5.3.3 The built-in Endpoints used by the Simple Participant Discovery Protocol

Figure 8.28 illustrates the built-in Endpoints introduced by the Simple Participant Discovery Protocol.

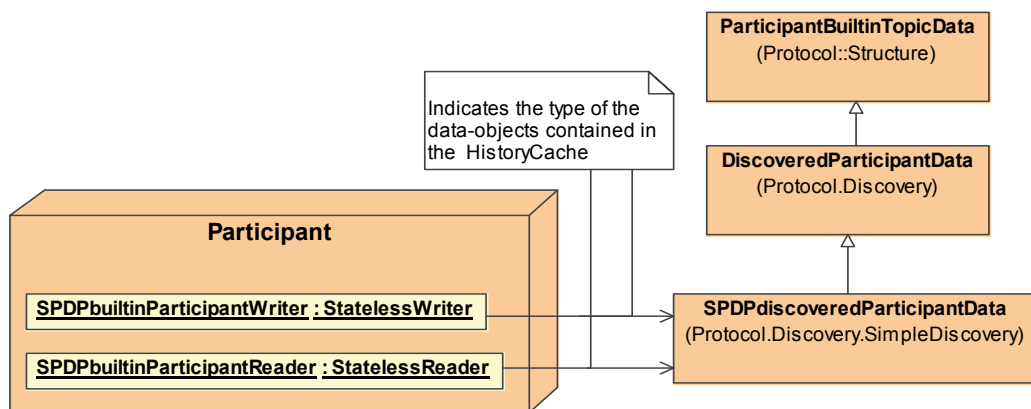

Figure 8.28 - The built-in Endpoints used by the Simple Participant Discovery Protocol

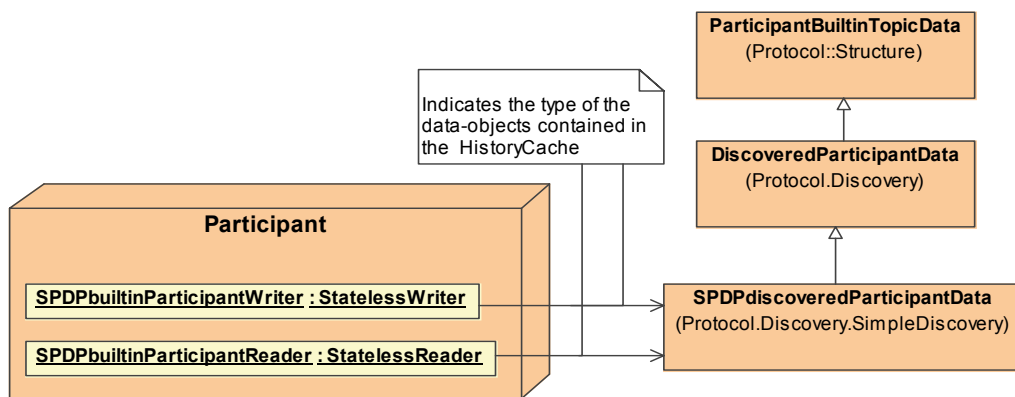

Figure 8.29 - The built-in Endpoints used by the Simple Participant Discovery Protocol

The Protocol reserves the following values of the *EntityId_t* for the SPDP built-in Endpoints:

```
ENTITYID_SPDP_BUILTIN_PARTICIPANT_WRITER
ENTITYID_SPDP_BUILTIN_PARTICIPANT_READER
```

8.5.3.3.1 SPDPbuiltinParticipantWriter

The relevant attribute values for configuring the *SPDPbuiltinParticipantWriter* are shown in Table 8.73.

Table 8.78 - Attributes of the RTPS StatelessWriter used by the SPDP

SPDPbuiltinParticipantWriter		
attribute	type	value
unicastLocatorList	Locator_t[*]	<auto-detected> Transport-kinds and addresses are either auto-detected or configured by the application. Ports are a parameter to the SPDP initialization or else are set to a PSM-specified value that depends on the domainId.
multicastLocatorList	Locator_t[*]	<parameter to the SPDP initialization> Defaults to a PSM-specified value.
reliabilityLevel	ReliabilityKind_t	BEST_EFFORT
topicKind	TopicKind_t	WITH_KEY
resendPeriod	Duration_t	<parameter to the SPDP initialization> Defaults to a PSM-specified value.
readerLocators	ReaderLocator[*]	<parameter to the SPDP initialization>

8.5.3.3.2 SPDPbuiltinParticipantReader

The *SPDPbuiltinParticipantReader* is configured with the attribute values shown in Table 8.74.

Table 8.79 - Attributes of the RTPS StatelessReader used by the SPDP

SPDPbuiltinParticipantReader		
attribute	type	value
unicastLocatorList	Locator_t[*]	<auto-detected> Transport-kinds and addresses are either auto-detected or configured by the application. Ports are a parameter to the SPDP initialization or else are set to a PSM-specified value that depends on the domainId.
multicastLocatorList	Locator_t[*]	<parameter to the SPDP initialization>. Defaults to a PSM-specified value.
reliabilityLevel	ReliabilityKind_t	BEST_EFFORT
topicKind	TopicKind_t	WITH_KEY

The **HistoryCache** of the *SPDPbuiltinParticipantReader* contains information on all active discovered participants; the key used to identify each data-object corresponds to the **Participant** GUID.

Each time information on a participant is received by the *SPDPbuiltinParticipantReader*; the SPDP examines the HistoryCache looking for an entry with a key that matches the Participant GUID. If an entry with a matching key is not there, a new entry is added keyed by the GUID of the Participant.

Periodically, the SPDP examines the *SPDPbuiltinParticipantReader* HistoryCache looking for stale entries defined as those that have not been refreshed for a period longer than their specified leaseDuration. Stale entries are removed.

8.5.3.4 Logical ports used by the Simple Participant Discovery Protocol

As mentioned above, each *SPDPbuiltinParticipantWriter* uses a pre-configured list of locators to announce a Participant’s presence on the network.

In order to enable plug-and-play interoperability, the pre-configured list of locators must use the following well-known logical ports:

Table 8.80 - Logical ports used by the Simple Participant Discovery Protocol

Port	Locators configured using this port
SPDP_WELL_KNOWN_UNICAST_PORT	entries in <i>SPDPbuiltinParticipantReader.unicastLocatorList</i> , unicast entries in <i>SPDPbuiltinParticipantWriter.readerLocators</i>
SPDP_WELL_KNOWN_MULTICAST_PORT	entries in <i>SPDPbuiltinParticipantReader.multicastLocatorList</i> , multicast entries in <i>SPDPbuiltinParticipantWriter.readerLocators</i>

The actual value for the logical ports is defined by the PSM.

8.5.4 The Simple Endpoint Discovery Protocol

An Endpoint Discovery Protocol defines the required information exchange between two **Participants** in order to discover each other’s **Writer** and **Reader** Endpoints.

A Participant may support multiple EDPs, but for the purpose of interoperability, all implementations must support at least the *Simple Endpoint Discovery Protocol*.

8.5.4.1 General Approach

Similar to the SPDP, the Simple Endpoint Discovery Protocol uses pre-defined built-in Endpoints. The use of pre-defined built-in Endpoints means that once a **Participant** knows of the presence of another **Participant**, it can assume the presence of the built-in Endpoints made available by the remote participant and establish the association with the locally-matching built-in Endpoints.

The protocol used to communicate between built-in Endpoints is the same as used for application-defined Endpoints. Therefore, by reading the built-in **Reader** Endpoints, the protocol virtual machine can discover the presence and QoS of the DDS Entities that belong to any remote **Participants**. Similarly, by writing the built-in **Writer** Endpoints a **Participant** can inform the other **Participants** of the existence and QoS of local DDS Entities.

The use of built-in topics in the SEDP therefore reduces the scope of the overall discovery protocol to the determination of which *Participants* are present in the system and the attribute values for the *ReaderProxy* and *WriterProxy* objects that correspond to the built-in Endpoints of these *Participants*. Once that is known, everything else results from the application of the RTPS protocol to the communication between the built-in RTPS *Readers* and *Writers*.

8.5.4.2 The built-in Endpoints used by the Simple Endpoint Discovery Protocol

The SEDP maps the DDS built-in Entities for the “DCPSSubscription,” “DCPSPublication,” and “DCPSTopic” Topics. According to the DDS specification, the reliability QoS for these built-in Entities is set to ‘reliable.’ The SEDP therefore maps each corresponding built-in DDS DataWriter or DataReader into corresponding *reliable* RTPS Writer and Reader Endpoints.

For example, as illustrated in Figure 8.30, the DDS built-in DataWriters for the “DCPSSubscription,” “DCPSPublication,” and “DCPSTopic” Topics can be mapped to reliable RTPS *StatefulWriters* and the corresponding DDS built-in DataReaders to reliable RTPS *StatefulReaders*. Actual implementations need not use the stateful reference implementation. For the purpose of interoperability, it is sufficient that an implementation provides the required built-in Endpoints and reliable communication that satisfies the general requirements listed in Section 8.4.2.

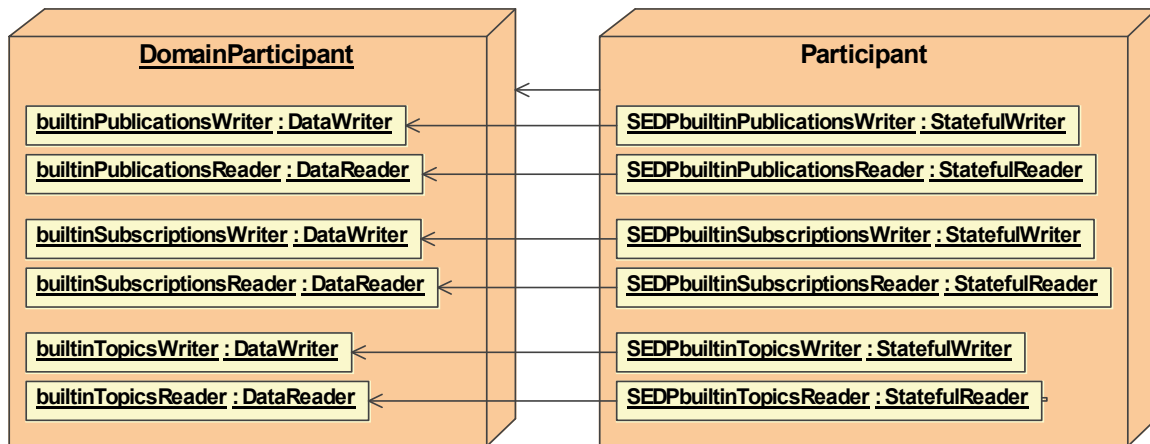

Figure 8.30 - Example mapping of the DDS Built-in Entities to corresponding RTPS built-in Endpoints

The RTPS Protocol reserves the following values of the *EntityId_t* for the built-in Endpoints:

```
ENTITYID_SEDP_BUILTIN_PUBLICATIONS_WRITER
ENTITYID_SEDP_BUILTIN_PUBLICATIONS_READER
ENTITYID_SEDP_BUILTIN_SUBSCRIPTIONS_WRITER
ENTITYID_SEDP_BUILTIN_SUBSCRIPTIONS_READER
ENTITYID_SEDP_BUILTIN_TOPIC_WRITER
ENTITYID_SEDP_BUILTIN_TOPIC_READER
```

The actual value for the reserved *EntityId_t* is defined by each PSM.

8.5.4.3 Built-in Endpoints required by the Simple Endpoint Discovery Protocol

Implementations are not required to provide all built-in Endpoints.

As mentioned in the DDS specification, Topic propagation is optional. Therefore, it is not required to implement the *SEDPbuiltinTopicsReader* and *SEDPbuiltinTopicsWriter* built-in Endpoints and for the purpose of interoperability, implementations should not rely on their presence in remote Participants.

As far as the remaining built-in Endpoints are concerned, a Participant is only required to provide the built-in Endpoints required for matching up local and remote Endpoints. For example, if a DDS Participant will only contain DDS DataWriters, the only required RTPS built-in Endpoints are the *SEDPbuiltinPublicationsWriter* and the *SEDPbuiltinSubscriptionsReader*. The *SEDPbuiltinPublicationsReader* and the *SEDPbuiltinSubscriptionsWriter* built-in Endpoints serve no purpose in this case.

The SPDP specifies how a Participant informs other Participants about what built-in Endpoints it has available. This is discussed in Section 8.5.3.2.

8.5.4.4 Data Types associated with built-in Endpoints used by the Simple Endpoint Discovery Protocol

Each RTPS *Endpoint* has a *HistoryCache* that stores changes to the data-objects associated with the *Endpoint*. This also applies to the RTPS built-in *Endpoints*. Therefore, each RTPS built-in *Endpoint* depends on some *DataType* that represents the logical contents of the data written into its *HistoryCache*.

Figure 8.31 defines the *DiscoveredWriterData*, *DiscoveredReaderData*, and *DiscoveredTopicData* *DataTypes* associated with the RTPS built-in Endpoints for the “DCPSPublication,” “DCPSSubscription,” and “DCPSTopic” Topics. The *DataType* associated with the “DCPSParticipant” Topic is defined in Section 8.5.3.2.

The *DataType* associated with each RTPS built-in Endpoint contains all the information specified by DDS for the corresponding built-in DDS Entity. For this reason, *DiscoveredReaderData* extends the DDS-defined *DDS::SubscriptionBuiltinTopicData*, *DiscoveredWriterData* extends *DDS::PublicationBuiltinTopicData*, and *DiscoveredTopicData* extends *DDS::TopicBuiltinTopicData*.

In addition to the data needed by the associated built-in DDS Entities, the “Discovered” *DataTypes* also include all the information that may be needed by an implementation of the protocol to configure the RTPS Endpoints. This information is contained in the RTPS *ReaderProxy* and *WriterProxy*.

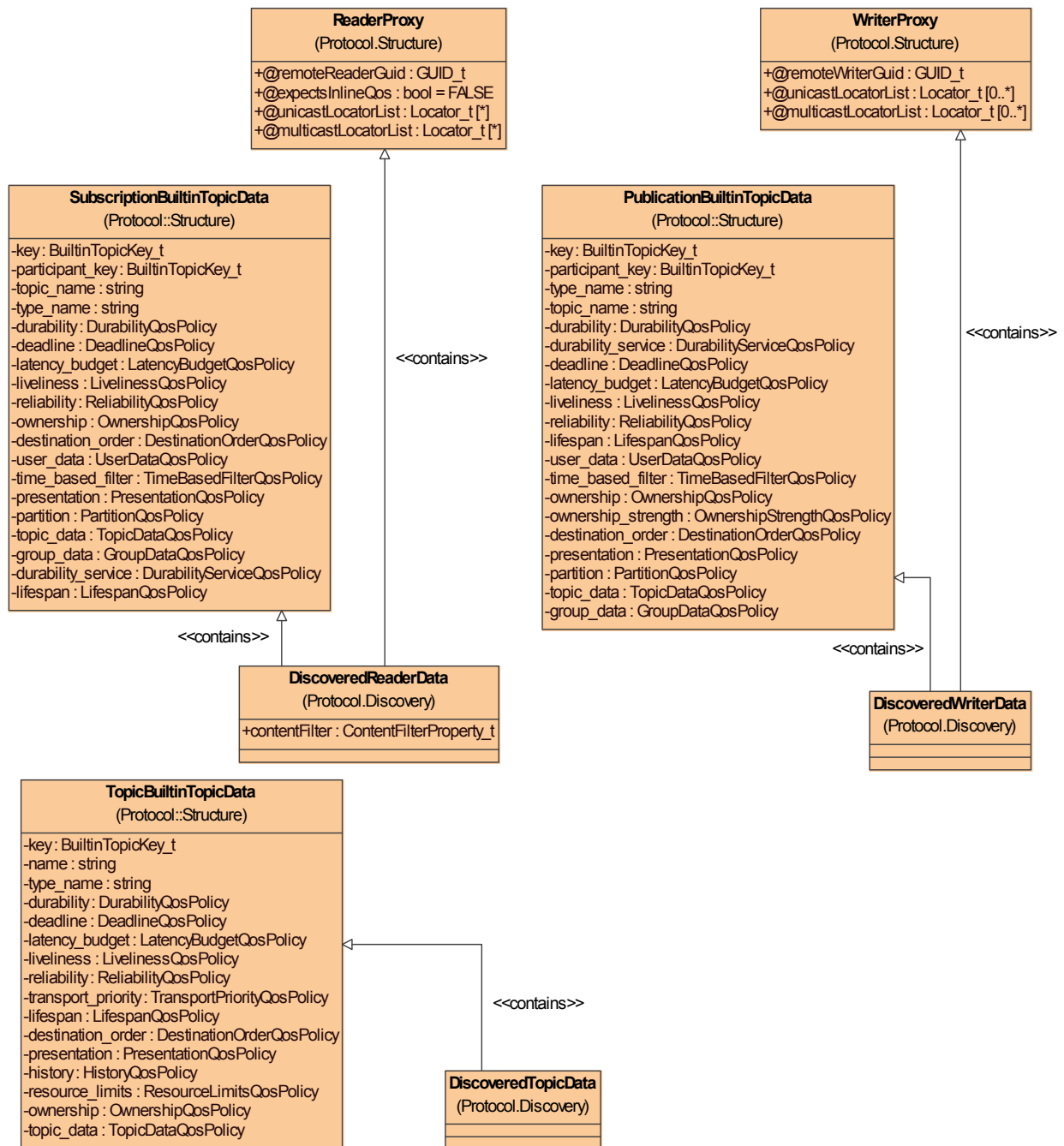

Figure 8.31 - Data types associated with built-in Endpoints used by the Simple Endpoint Discovery Protocol

An implementation of the protocol need not necessarily send all information contained in the DataTypes. If any information is not present, the implementation can assume the default values, as defined by the PSM. The PSM also defines how the discovery information is represented on the wire.

The RTPS built-in Endpoints used by the SEDP and their associated DataTypes are shown in Figure 8.32.

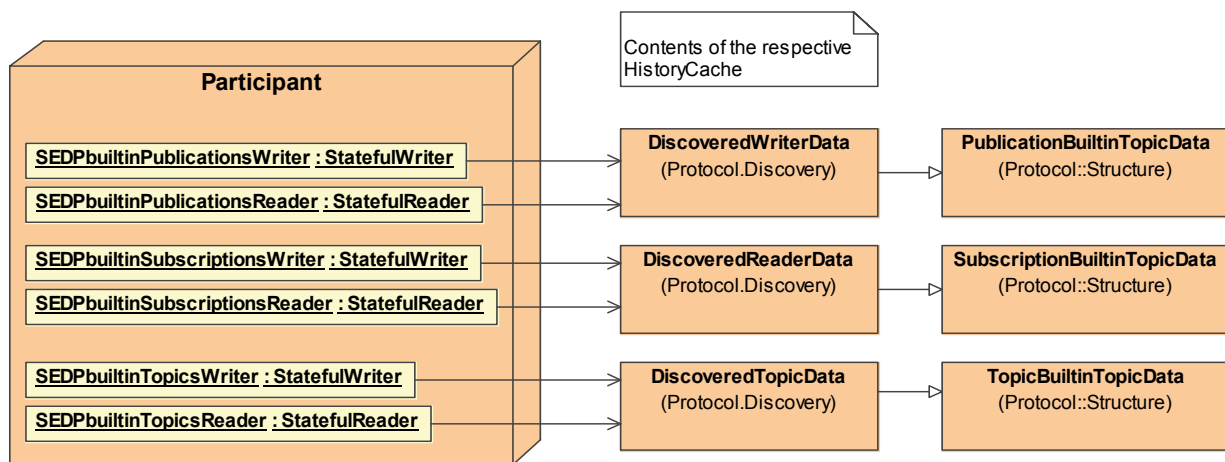

Figure 8.32 - Built-in Endpoints and the DataType associated with their respective HistoryCache

The contents of the *HistoryCache* for each built-in Endpoint can be described in terms of the following aspects: DataType, Cardinality, Data-object insertion, Data-object modification, and Data-object deletion.

- **DataType.** The type of the data stored in the cache. This is partly defined by the DDS specification.
- **Cardinality.** The number of different data-objects (each with a different key) that can potentially be stored in the cache.
- **Data-object insertion.** Conditions under which a new data-object is inserted into the cache.
- **Data-object modification.** Conditions under which the value of an existing data-object is modified.
- **Data-object deletion.** Conditions under which an existing data-object is removed from the cache.

It is illustrative to describe the *HistoryCache* for each of the built-in Endpoints.

8.5.4.4.1 SEDPbuiltinPublicationsWriter and SEDPbuiltinPublicationsReader

Table 8.76 describes the *HistoryCache* for the *SEDPbuiltinPublicationsWriter* and *SEDPbuiltinPublicationsReader*.

Table 8.81 - Contents of the HistoryCache for the SEDPbuiltinPublicationsWriter and SEDPbuiltinPublicationsReader

aspect	description
DataType	DiscoveredWriterData

Table 8.81 - Contents of the HistoryCache for the SEDPbuiltinPublicationsWriter and SEDPbuiltinPublicationsReader

aspect	description
Cardinality	The number of DataWriters contained by the DomainParticipant. There is a one-to-one correspondence between each DataWriter in the participant and a data-object that describes the DataWriter stored in the WriterHistoryCache for the SEDPbuiltinPublicationsWriter.
Data-Object insertion	Each time a DataWriter is created in the DomainParticipant.
Data-Object modification	Each time the QoS of an existing DataWriter is modified.
Data-Object deletion	Each time an existing DataWriter belonging to the DomainParticipant is deleted.

8.5.4.4.2 SEDPbuiltinSubscriptionsWriter and SEDPbuiltinSubscriptionsReader

Table 8.77 describes the HistoryCache for the SEDPbuiltinSubscriptionsWriter and SEDPbuiltinSubscriptionsReader.

Table 8.82 - Contents of the HistoryCache for the SEDPbuiltinSubscriptionsWriter and SEDPbuiltinSubscriptionsReader

aspect	description
DataType	DiscoveredReaderData
Cardinality	The number of DataReaders contained by the DomainParticipant. There is a one-to-one correspondence between each DataReaders in the Participant and a data-object that describes the DataReaders stored in the WriterHistoryCache for the SEDPbuiltinSubscriptionsWriter.
Data-Object insertion	Each time a DataReader is created in the DomainParticipant.
Data-Object modification	Each time the QoS of an existing DataReader is modified.
Data-Object deletion	Each time an existing DataReader belonging to the DomainParticipant is deleted.

8.5.4.4.3 SEDPbuiltinTopicsWriter and SEDPbuiltinTopicsReader

Table 8.78 describes the HistoryCache for the SEDPbuiltinTopicsWriter and builtinTopicsReader.

Table 8.83 - Contents of the HistoryCache for the SEDPbuiltinTopicsWriter and SEDPbuiltinTopicsReader

aspect	description
DataType	DiscoveredTopicData
Cardinality	The number of Topics created by the DomainParticipant. There is a one-to-one correspondence between each Topic created by the DomainParticipant and a data-object that describes the Topic stored in the WriterHistoryCache for the builtinTopicsWriter.
Data-Object insertion	Each time a Topic is created in the DomainParticipant.

Table 8.83 - Contents of the HistoryCache for the SEDPbuiltinTopicsWriter and SEDPbuiltinTopicsReader

aspect	description
Data-Object modification	Each time the QoS of an existing Topic is modified.
Data-Object deletion	Each time an existing Topic belonging to the DomainParticipant is deleted.

8.5.5 Interaction with the RTPS virtual machine

To further illustrate the SPDP and SEDP, this section describes how the information provided by the SPDP can be used to configure the SEDP built-in Endpoints in the RTPS virtual machine.

8.5.5.1 Discovery of a new remote Participant

Using the *SPDPbuiltinParticipantReader*, a local *Participant* ‘*local_participant*’ discovers the existence of another *Participant* described by the *DiscoveredParticipantData* *participant_data*. The discovered *Participant* uses the SEDP.

The pseudo code below configures the local SEDP built-in *Endpoints* within *local_participant* to communicate with the corresponding SEDP built-in *Endpoints* in the discovered *Participant*.

Note that how the *Endpoints* are configured depends on the implementation of the protocol. For the stateful reference implementation, this operation performs the following logical steps:

```

IF ( PUBLICATIONS_READER IS_IN participant_data.availableEndpoints ) THEN
    guid = <participant_data.guidPrefix, ENTITYID_SEDP_BUILTIN_PUBLICATIONS_READER>;
    writer = local_participant.SEDPbuiltinPublicationsWriter;
    proxy = new ReaderProxy( guid,
        participant_data.metatrafficUnicastLocatorList,
        participant_data.metatrafficMulticastLocatorList);
    writer.matched_reader_add(proxy);
ENDIF

IF ( PUBLICATIONS_WRITER IS_IN participant_data.availableEndpoints ) THEN
    guid = <participant_data.guidPrefix, ENTITYID_SEDP_BUILTIN_PUBLICATIONS_WRITER>;
    reader = local_participant.SEDPbuiltinPublicationsReader;
    proxy = new WriterProxy( guid,
        participant_data.metatrafficUnicastLocatorList,
        participant_data.metatrafficMulticastLocatorList);
    reader.matched_writer_add(proxy);
ENDIF

IF ( SUBSCRIPTIONS_READER IS_IN participant_data.availableEndpoints ) THEN
    guid = <participant_data.guidPrefix, ENTITYID_SEDP_BUILTIN_SUBSCRIPTIONS_READER>;
    writer = local_participant.SEDPbuiltinSubscriptionsWriter;
    proxy = new ReaderProxy( guid,
        participant_data.metatrafficUnicastLocatorList,
        participant_data.metatrafficMulticastLocatorList);
    writer.matched_reader_add(proxy);
ENDIF

IF ( SUBSCRIPTIONS_WRITER IS_IN participant_data.availableEndpoints ) THEN
    guid = <participant_data.guidPrefix, ENTITYID_SEDP_BUILTIN_SUBSCRIPTIONS_WRITER>;
    reader = local_participant.SEDPbuiltinSubscriptionsReader;
    proxy = new WriterProxy( guid,
        participant_data.metatrafficUnicastLocatorList,
        participant_data.metatrafficMulticastLocatorList);

```



```

        reader.matched_writer_add(proxy);
ENDIF

IF ( TOPICS_READER IS_IN participant_data.availableEndpoints ) THEN
    guid = <participant_data.guidPrefix, ENTITYID_SEDP_BUILTIN_TOPICS_READER>;
    writer = local_participant.SEDPbuiltinTopicsWriter;
    proxy = new ReaderProxy( guid,
        participant_data.metatrafficUnicastLocatorList,
        participant_data.metatrafficMulticastLocatorList);
    writer.matched_reader_add(proxy);
ENDIF

IF ( TOPICS_WRITER IS_IN participant_data.availableEndpoints ) THEN
    guid = <participant_data.guidPrefix, ENTITYID_SEDP_BUILTIN_TOPICS_WRITER>;
    reader = local_participant.SEDPbuiltinTopicsReader;
    proxy = new WriterProxy( guid,
        participant_data.metatrafficUnicastLocatorList,
        participant_data.metatrafficMulticastLocatorList);
    reader.matched_writer_add(proxy);
ENDIF

```

8.5.5.2 Removal of a previously discovered Participant

Based on the remote *Participant's* *leaseDuration*, a local *Participant* '*local_participant*' concludes that a previously discovered *Participant* with GUID_t *participant_guid* is no longer present. The *Participant* '*local_participant*' must reconfigure any local Endpoints that were communicating with Endpoints in the *Participant* identified by the GUID_t *participant_guid*.

For the stateful reference implementation, this operation performs the following logical steps:

```

guid = <participant_guid.guidPrefix, ENTITYID_SEDP_BUILTIN_PUBLICATIONS_READER>;
writer = local_participant.SEDPbuiltinPublicationsWriter;
proxy = writer.matched_reader_lookup(guid);
writer.matched_reader_remove(proxy);

guid = <participant_guid.guidPrefix, ENTITYID_SEDP_BUILTIN_PUBLICATIONS_WRITER>;
reader = local_participant.SEDPbuiltinPublicationsReader;
proxy = reader.matched_writer_lookup(guid);
reader.matched_writer_remove(proxy);

guid = <participant_guid.guidPrefix, ENTITYID_SEDP_BUILTIN_SUBSCRIPTIONS_READER>;
writer = local_participant.SEDPbuiltinSubscriptionsWriter;
proxy = writer.matched_reader_lookup(guid);
writer.matched_reader_remove(proxy);

guid = <participant_guid.guidPrefix, ENTITYID_SEDP_BUILTIN_SUBSCRIPTIONS_WRITER>;
reader = local_participant.SEDPbuiltinSubscriptionsReader;
proxy = reader.matched_writer_lookup(guid);
reader.matched_writer_remove(proxy);

guid = <participant_guid.guidPrefix, ENTITYID_SEDP_BUILTIN_TOPICS_READER>;
writer = local_participant.SEDPbuiltinTopicsWriter;
proxy = writer.matched_reader_lookup(guid);
writer.matched_reader_remove(proxy);

guid = <participant_guid.guidPrefix, ENTITYID_SEDP_BUILTIN_TOPICS_WRITER>;
reader = local_participant.SEDPbuiltinTopicsReader;
proxy = reader.matched_writer_lookup(guid);
reader.matched_writer_remove(proxy);

```

8.5.6 Supporting Alternative Discovery Protocols

The requirements on the Participant and Endpoint Discovery Protocols may vary depending on the deployment scenario. For example, a protocol optimized for speed and simplicity (such as a protocol that would be deployed in embedded devices on a LAN) may not scale well to large systems in a WAN environment.

For this reason, the RTPS specification allows implementations to support multiple PDPs and EDPs. There are many possible approaches to implementing a Discovery Protocol including the use of static discovery, file based discovery, a central look-up service, etc. The only requirement imposed by RTPS for the purpose of interoperability is that all RTPS implementations support at least the SPDP and SEDP. It is expected that over time, a collection of interoperable Discovery Protocols will be developed to address specific deployment needs.

If an implementation supports multiple PDPs, each PDP may be initialized differently and discover a different set of remote Participants. Remote Participants using a different vendor's RTPS implementation must be contacted using at least the SPDP to ensure interoperability. There is no such requirement when the remote Participant uses the same RTPS implementation.

Even when the SPDP is used by all Participants, remote Participants may still use different EDPs. Which EDPs a Participant supports is included in the information exchanged by the SPDP. All Participants must support at least the SEDP, so they always have at least one EDP in common. However, if two Participants both support another EDP, this alternative protocol can be used instead. In that case, there is no need to create the SEDP built-in Endpoints, or if they already exist, no need to configure them to match the new remote Participant. This approach enables a vendor to customize the EDP if desired without compromising interoperability.

8.6 Versioning and Extensibility

Implementations of this version of the RTPS protocol (~~2.0~~) should be able to process RTPS Messages not only with the same major version (~~2~~) but possibly higher minor versions.

8.6.1 Allowed Extensions within this major Version

Within this major version, future minor versions of the protocol can augment the protocol in the following ways:

- Additional Submessages with other *submessageIds* can be introduced and used anywhere in an RTPS Message. An implementation should skip over unknown Submessages using the *submessageLength* field in the SubmessageHeader.
- Additional fields can be added to the end of a Submessage that was already defined in the current minor version. An implementation should skip over additional fields using the *submessageLength* field in the SubmessageHeader.
- Additional built-in Endpoints with new IDs can be added. An implementation should ignore any unknown built-in Endpoints.
- Additional parameters with new *parameterIds* can be added. An implementation should ignore any unknown parameters.

All such changes require an increase of the minor version number.

8.6.2 What cannot change within this major Version

The following items cannot be changed within the same major version:

- A Submessage cannot be deleted.
- A Submessage cannot be modified except as described in Section 8.6.1.
- The meaning of *submessageIds* cannot be modified.

All such changes require an increase in the major version number.

8.7 Implementing DDS QoS and advanced DDS features using RTPS

The RTPS protocol and its extension mechanisms provide the core functionality required to implement DDS. This section defines how to use RTPS to implement the DDS QoS parameters.

In addition, this section defines the RTPS protocol extensions required for implementing the following advanced DDS features:

- Content-filtered Topics, see Section 8.7.3
- Coherent Sets, see Section 8.7.5

All extensions are based on the standard extension mechanisms provided by RTPS.

This section forms a normative part of the specification for the purpose of interoperability.

8.7.1 Adding in-line Parameters to Data Submessages

~~Data~~, ~~NoKeyData~~, ~~DataFrag~~ and ~~NoKeyDataFrag~~ Submessages optionally contain a **ParameterList** SubmessageElement for storing in-line QoS parameters and other information.

In case a **Reader** does not keep a list of matching remote **Writers** or the QoS parameters they were configured with (i.e. is a stateless **Reader**), a **Data** Submessage with in-line QoS parameters contains all the information needed to enable the **Reader** to apply all **Writer**-specific QoS parameters.

A stateless **Reader**'s need for receiving in-line QoS to get information on remote **Writers** is the justification for requiring a **Writer** to send in-line QoS if the **Reader** requests them (Section 8.4.2.2.2).

For immutable QoS, all RxO QoS are sent in-line to allow a stateless **Reader** to reject samples in case of incompatible QoS. Mutable QoS relevant to the **Reader** are sent in-line so they may take effect immediately, regardless of the amount of state kept on the **Reader**. Note that a stateful **Reader** has the option of relying on its cached information of remote **Writers** rather than the received in-line QoS.

A stateless **Reader** uses the discovery protocol to announce to remote **Writers** that it expects to receive QoS parameters in-line, as discussed in the Discovery Module (Section 8.5). If in-line QoS parameters are expected, implementations must also include the topic name as an in-line parameter. This ensures that on the receiving side, the Submessage can be passed to all **Readers** for that topic, including the stateless **Readers**.

Independent of whether **Readers** expect in-line QoS parameters, a **Data** Submessage may also contain in-line parameters related to coherent sets and content-filtered topics. This is described in more detail in the sections that follow.

For improved performance, stateful implementations may ignore in-line QoS and instead rely solely on cached values obtained through Discovery. Note that not parsing in-line QoS may delay the point in time when a new WoS takes effect, as it first must be propagated through Discovery.

8.7.2 DDS QoS Parameters

Table 8.79 provides an overview of which QoS parameters affect the RTPS wire protocol and which can appear as in-line QoS. The parameters that affect the wire protocol are discussed in more detail in the subsections below.

Table 8.84 - Implementing DDS QoS Parameters using the RTPS Wire Protocol

QoS	Effect on RTPS Protocol	May appear as in-line QoS
USER_DATA	None	No
TOPIC_DATA	None	No
GROUP_DATA	None	No
DURABILITY	See Section 8.7.2.2.1	Yes
DURABILITY_SERVICE	None	No
PRESENTATION	See Section 8.7.2.2.2	Yes
DEADLINE	None	Yes
LATENCY_BUDGET	None	Yes
OWNERSHIP	None	Yes
OWNERSHIP_STRENGTH	None	Yes
LIVELINESS	See Section 8.7.2.2.3	Yes
TIME_BASED_FILTER	See Section 8.7.2.2.4	No
PARTITION	None	Yes
RELIABILITY	See Section 8.7.2.2.5	Yes
TRANSPORT_PRIORITY	None	Yes
LIFESPAN	None	Yes
DESTINATION_ORDER	See Section 8.7.2.2.6	Yes
HISTORY	None	No
RESOURCE_LIMITS	None	No
ENTITY_FACTORY	None	No
WRITER_DATA_LIFECYCLE	See Section 8.7.2.2.7	No
READER_DATA_LIFECYCLE	None	No

8.7.2.1 In-line DDS QoS Parameters

Table 8.79 lists the standard DDS QoS parameters that may appear in-line.

If a *Reader* expects to receive in-line QoS parameters and any of these QoS parameters are missing, it will assume the default value for that QoS parameter, where the default is defined by DDS.

In-line parameters are added to data submessages to make them self-describing. In order to achieve self-describing messages, not only the parameters defined in Table 8.79 have to be sent with the submessage, but also a parameter `TOPIC_NAME`. This parameter contains the name of the topic that the submessage belongs to.

8.7.2.2 DDS QoS Parameters that affect the wire protocol

8.7.2.2.1 DURABILITY

While volatile and transient-local durability do not affect the RTPS protocol, support for transient and persistent durability may. This is not covered in the current version of the specification.

8.7.2.2.2 PRESENTATION

Section 8.7.5 defines how to implement the coherent access policy of the PRESENTATION QoS.

The other aspects of this QoS do not affect the RTPS protocol.

8.7.2.2.3 LIVELINESS

Implementations must follow the approaches below:

- `DDS_AUTOMATIC_LIVELINESS_QOS` : liveliness is maintained through the *BuiltinParticipantMessageWriter*. For a given *Participant*, in order to maintain the liveliness of its *Writer* Entities with LIVELINESS QoS set to AUTOMATIC, implementations must refresh the *Participant's* liveliness (i.e., send the *ParticipantMessageData*, see Section 8.4.13.5) at a rate faster than the smallest lease duration among the *Writers*.
- `DDS_MANUAL_BY_PARTICIPANT_LIVELINESS_QOS` : liveliness is maintained through the *BuiltinParticipantMessageWriter*. If the *Participant* has any `MANUAL_BY_PARTICIPANT` *Writers*, implementations must check periodically to see if `write()`, `assert_liveliness()`, `dispose()`, or `unregister_instance()` was called for any of them. The period for this check equals the smallest lease duration among the *Writers*. If any of the operations were called, implementations must refresh the *Participant's* liveliness (i.e., send the *ParticipantMessageData*, see Section 8.4.13.5).
- `DDS_MANUAL_BY_TOPIC_LIVELINESS_QOS` : liveliness is maintained by sending data or an explicit **Heartbeat** message with liveliness flag set. The standard RTPS Messages that result from calling `write()`, `dispose()`, or `unregister_instance()` on a *Writer* Entity suffice to assert the liveliness of a *Writer* with LIVELINESS QoS set to `MANUAL_BY_TOPIC`. When `assert_liveliness()` is called, the *Writer* must send a **Heartbeat** Message with final flag and liveliness flag set.

8.7.2.2.4 TIME_BASED_FILTER

Implementations may optimize bandwidth usage by applying a time based filter on the *Writer* side. That way, data that would be dropped on the *Reader* side is never sent.

When one or more data updates are filtered out on the *Writer* side, implementations must send a **Gap** Submessage instead, indicating which samples were filtered out. This Submessage must be sent before the next update and notifies the Reader the missing updates were filtered out and not simply lost.

8.7.2.2.5 RELIABILITY

Implementations must meet the reliable RTPS protocol requirements for interoperability, defined in Section 8.4.2.

8.7.2.2.6 DESTINATION_ORDER

In order to implement the `DDS_BY_SOURCE_TIMESTAMP_DESTINATIONORDER_QOS` policy, implementations must include an `InfoTimestamp` Submessage with every update from a *Writer*.

8.7.2.2.7 WRITER_DATA_LIFECYCLE

If `autodispose_unregistered_instances` is enabled, `Data` Messages that unregister an instance must also dispose it. This restricts the allowable values of the `DisposedFlag` and `UnregisteredFlag` flags.

8.7.3 Content-filtered Topics

Content-filtered topics make it possible for a DDS `DataReader` to request the middleware to filter out data samples based on their contents.

When filtering on the Reader side only, samples which do not pass the filter are simply dropped by the middleware. In this case, no further extensions to RTPS are needed.

In many cases, implementations will benefit from filtering on the Writer side, in addition to filtering on the Reader side. By filtering on the Writer side, a sample that would not pass any Reader side filters will not be sent. This conserves bandwidth. Likewise, when a sample does get sent, a Writer can include information on what filters it passed. This makes it possible to apply a filter only once on the Writer side, as opposed to once for each Reader. Readers will simply check whether a sample was filtered previously on the Writer side. If so, the filter need not be applied.

In order to support Writer side filtering, standard RTPS extension mechanisms are used to:

- include Reader filter information during the Endpoint discovery phase
- include filter results with each data sample

8.7.3.1 Exchanging filter information using the built-in Endpoints

Content-filtered topics are defined on the Reader side. In order to implement Writer side filtering, information on the filter used by a given Reader must be propagated to matching remote Writers. This requires extending the data type associated with RTPS built-in Endpoints.

As illustrated in Figure 8.32, the data types associated with RTPS built-in Endpoints extend the DDS built-in topic data types, which include all relevant QoS. Since DDS does not define content-filtered topics as a Reader QoS policy (instead, DDS defines separate Content-filtered Topics), RTPS adds an additional `ContentFilterProperty_t` field to `DiscoveredReaderData`, defined in Table 8.80.

Table 8.85 - Content filter property

ContentFilterProperty_t		
attribute	type	value
contentFilteredTopicName	string	Name of the Content-filtered Topic associated with the Reader. Must have non-zero length.
relatedTopicName	string	Name of the Topic related to the Content-filtered Topic. Must have non-zero length.
filterClassName	string	Identifies the filter class this filter belongs to. RTPS can support multiple filter classes (SQL, regular expressions, custom filters, etc). Must have non-zero length. RTPS predefines the following values: "DDSSQL" Default filter class name if none specified. Matches the SQL filter specified by DDS, which must be available in all implementations.
filterExpression	string	The actual filter expression. Must be a valid expression for the filter class specified using <i>filterClassName</i> . Must have non-zero length.
expressionParameters	stringSequence	Defines the value for each parameter in the filter expression. Can have zero length if the filter expression contains no parameters.

The *ContentFilterProperty_t* field provides all the required information to enable content filtering on the Writer side. For example, for the default DDSSQL filter class, a valid filter expression for a data type containing members a, b and c could be “(a < 5) AND (b == %0) AND (c >= %1)” with expression parameters “5” and “3.” In order for the Writer to apply the filter, it must have been configured to handle filters of the specified filter class. If not, the Writer will simply ignore the filter information and not filter any data samples.

DDS allows the user to modify the filter expression parameters at run-time. Each time the parameters are modified, the updated information is exchanged using the Endpoint discovery protocol. This is identical to updating a mutable QoS value.

8.7.3.2 Including in-line filter results with each data sample

In general, when applying filtering on the Writer side, a sample is not sent if it does not pass the remote Reader’s filter. In that case, the **Data** submessage is replaced by a **Gap** submessage. This ensures the sample is not considered ‘lost’ on the Reader side. This approach matches that of applying a time-based filter on the Writer side. The remainder of the discussion only refers to **Data** Submessages, but the same approach is followed for ~~NoKeyData, DataFrag, and NoKeyDataFrag~~ Submessages.

In some cases, it may still be possible for a Reader to receive a sample that did not pass its filter, for example when sending data using multicast. Another use case is multiple Readers belonging to the same Participant. In that case, the Writer need only send a single RTPS message, destined to ENTITYID_UNKNOWN (see Section 8.4.15.5). Each Reader may use a different filter however, in which case the Writer needs to apply multiple filters before sending the sample.

In both use cases, two options exist:

- The sample passes none of the filters for any of the remote Readers. In that case, the **Data** submessage is again replaced by a **Gap** submessage.
- The sample passes some or all of the filters. In that case, the sample must still be sent and the writer must include information with the **Data** submessage on what filters were applied and the according result.

The *inlineQos* element of the **Data** submessage is used to include the necessary filter information. More specifically, a new parameter is added, containing the information shown in Table 8.81.

Table 8.86 - Content filter info associated with a data sample

ContentFilterInfo_t		
attribute	type	value
filterResult	FilterResult_t	For each filter signature, the results indicate whether the sample passed the filter.
filterSignatures	FilterSignature_t[]	A list of filters that were applied to the sample.

A filter signature *FilterSignature_t* uniquely identifies a filter and is based on the filter properties listed in Table 8.80. How to represent and calculate a filter signature is defined by the PSM. Whether the sample passed the filters that were applied on the **Writer** side is encoded by the *filterResult_t* attribute, again defined by the PSM.

Note that a filter signature changes when the filter’s expression parameters change. Until it receives updated parameter values, a Writer side filter may be using outdated expression parameters, in which case the in-line filter signature will not match the signature expected by the Reader. As a result, the Reader will ignore the filter results and instead apply its local filter.

8.7.3.3 Requirements for Interoperability

Writer side filtering constitutes an optimization and is optional, so it is not required for interoperability.

Samples will always be filtered on the Reader side if

- the Writer side did not apply any filtering.
- the Writer side did not apply the filter expected by the Reader.
As mentioned earlier, this may occur if the Writer has not yet been informed about updated filter parameters.
- the Reader side does not support Writer side filtering (and therefore ignores in-line filter information).

Likewise, Writers may not filter samples because

- the implementation does not support Content-filtered Topics (in which case the filter properties of the Reader are ignored).

- the Reader's filter information was rejected (e.g., unrecognized filter class).
If an implementation supports Content-filtered Topics, it must at least recognize the “DDSSQL” filter class, as mandated by the DDS specification. For all other filter classes, both implementations must allow the user to register the same custom filter class.
- other implementation-specific restrictions, such as a resource limit on the number of remote readers each writer is able to store filter information for.

8.7.4 Changes in the Instance LifecycleState

Beyond writing data, a DDS DataWriter can register data object instances (operation **register instance**), update their value (operation **write**), dispose data-object instances (operation **dispose**), and unregister them (operation **unregister instance**). Each one of these operations may cause notifications to be dispatched to the matched DDS DataReaders. The DDS DataReader can determine the nature of the change by inspecting the **LifecycleState instance state** field in the **SampleInfo** that is returned on the DDS DataReader **read** or **take** call.

RTPS uses regular **Data** Submessages and the in-line QoS parameter extension mechanism to communicate lifecycle changes. The serialized information within the inline QoS contains the new LifecycleState, that is, whether the instance has been registered, unregistered or disposed. The actual details depend on the PIM (e.g. see Section 9.6.3.4).

An implementation of RTPS must use the **Data** Submessage to communicate a lifecycle changes. When doing so an implementation of RTPS is allowed to include only the Key of the Data-Object within the SerializedPayload submessage element (see Section 8.3.7.2). This is because the Key is sufficient to uniquely identify the Data_Object instance to which the LifecycleState change applies.

An implementation of RTPS is not required to propagate registration changes until the DDS DataWriter writes the first value for that Data-Object instance.

8.7.5 Coherent Sets

The DDS specification provides the functionality to define a set of sample updates as a coherent set. A DataReader is only notified of the arrival of new updates once all updates in the coherent set have been received.

What constitutes a coherent set is defined on the DataWriter side by using the container Publisher to denote the beginning and end of the coherent set. A coherent set may span only the instances written to by a given DataWriter (access scope TOPIC) or may span across multiple DataWriters belonging to the same Publisher (access scope GROUP). Please refer to the DDS specification for additional details.

In order to support coherent sets, RTPS uses the in-line QoS parameter extension mechanism to include additional information in-line with each **Data** Submessage. The additional information denotes membership to a particular coherent set. The remainder of the discussion only refers to **Data** Submessages, but the same approach is followed for ~~NoKeyData, DataFrag and NoKeyDataFrag~~-Submessages.

For access scope TOPIC, all **Data** Submessages belonging to the same coherent set have strict monotonically increasing sequence numbers (as they originated from the same **Writer**). Therefore, a coherent set is uniquely identified by the sequence number of the first sample update belonging to the coherent set. All sample updates belonging to the same coherent set contain an in-line QoS parameter with this same sequence number. This approach also allows the **Reader** to easily determine when the coherent set started.

The end of a **Writer's** coherent set is defined by the arrival of one of the following:

- A **Data** Submessage from this **Writer** that belongs to a new coherent set.
- A **Data** Submessage from this **Writer** that does not contain a coherent set in-line QoS parameter or alternatively, contains a coherent set in-line QoS parameter with value SEQUENCENUMBER_UNKNOWN. Both approaches are equivalent.

Note that a **Data** or **NoKeyData**-Submessage need not necessarily contain *serializedDataPayload*. This makes it possible to notify the **Reader** about the end of a coherent set before the next data is written by the **Writer**.

Finally, the extensions required for access scope GROUP are not yet defined.

8.7.6 Directed Write

Direct peer-to-peer communications may be enabled within the publish-subscribe framework of DDS by tagging samples with the handles of the intended recipient(s).

RTPS supports directed writes by using the in-line QoS parameter extension mechanism. The serialized information denotes the GUIDs of the targeted reader(s).

When a writer sends a directed sample, only recipients with a matching GUID accept the sample; all other recipients acknowledge but absorb the sample, as if it were a GAP message.

8.7.7 Property Lists

Property lists are lists of user-definable properties applied to a DDS Entity. An entry in the list is a generic name-value pair. A user defines a pair to be a property for a DDS Participant, DataWriter, or DataReader. This extensible list enable non-DDS-specified properties to be applied.

The RTPS protocol supports Property Lists as in-line parameters. Properties can then be propagated during Discovery or as in-line QoS.

8.7.8 Original Writer Info

A service supporting the Persistent level of DDS Durability QoS needs to send the data that has been received and stored on behalf of the persistent writer.

This service that forwards messages needs to indicate that the forwarded message belongs to the message-stream of another writer, such that if the reader receives the same messages from another source (for example, another forwarding service or the original writer), it can treat them as duplicates.

The RTPS protocol supports this forwarding of messages by including information of the original writer.

When a RTPS Reader receives this information, it will treat it as a normal CacheChange, but once the CacheChange is ready to be committed to the DDS DataReader, it will not commit it. Instead, it will hand it off to the HistoryCache of the RTPS Reader that is communicating with the RTPS Writer indicated in the ORIGINAL_WRITER_INFO in-line QoS and treat it as having the sequence number which appears there and the ParameterList also included in the ORIGINAL_WRITER_INFO.

Table 8.87 - Original writer info

OriginalWriterInfo_t		
attribute	type	value
originalWriterGUID	GUID_t	The GUID of the RTPS Writer that first generated the message
originalWriterSN	SequenceNumber_t	The Sequence Number of the CacheChange as sent from the original writer
originalWriterQoS	ParameterList	The list of in-line parameters that should apply to the CacheChange as sent by the RTPS Writer that first generated the sample

8.7.9 Key Hash

The Key Hash provides a hint for the key that uniquely identifies the data-object that is being changed within the set of objects that have been registered by the DDS DataWriter.

Nominally the key is part of the serialized data of a data submessage. Using the key hash benefits implementations by providing a faster alternative than deserializing the full key from the received data-object.

When the key hash is not received by a DataReader, it should be computed from the data itself. If there is no data in the submessage, then a default zero-valued key hash should be used by the DataReader.

A KeyHash, if present, shall be computed as described in Section 9.6.3.3.

9 Platform Specific Model (PSM) : UDP/IP

9.1 Introduction

This chapter defines the Platform Specific Model (PSM) that maps the Protocol PIM to UDP/IP. The goal for this PSM is to provide a mapping with minimal overhead directly on top of UDP/IP.

The suitability of UDP/IP as a transport for DDS applications stems from several factors:

- Universal availability. Being a core part of the IP stack, UDP/IP is available on virtually all operating systems.
- Light-weight. UDP/IP is a very simple protocol that adds minimal services on top of IP. Its use enables the use of IP-based networks with the minimal possible overhead.
- Best-effort. UDP/IP provides a best-effort service which maps well to Quality-of-service needs of many real-time data streams. In the situations where it is needed, the RTPS protocol provides the mechanism to attain reliable delivery on top of the best-effort service provided by UDP.
- Connectionless. UDP/IP offers a connectionless service; this allows multiple RTPS endpoints to share a single operating-system UDP resource (socket/port) while allowing for interleaving of messages effectively providing an out-of-band mechanism for each separate data-stream.
- Predictable behavior. Unlike TCP, UDP does not introduce timers that would cause operations to block for varying amounts of time. As such, it is simpler to model the impact of using UDP on a real-time application.
- Scalability and multicast support. UDP/IP natively supports multicast which allows efficient distribution of a single message to a large number of recipients.

9.2 Notational Conventions

9.2.1 Name Space

All the definitions in this document are part of the “RTPS” name-space. To facilitate reading and understanding, the name-space prefix has been left out of the definitions and classes in this document.

9.2.2 IDL Representation of Structures and CDR Wire Representation

The following sections often define structures, such as:

```
struct {
    octet[3] entityKey;
    octet entityKind;
} EntityId_t;
```

These definitions use the OMG IDL (Interface Definition Language). When these structures are sent on the wire, they are encoded using the corresponding CDR representation.

9.2.3 Representation of Bits and Bytes

This document often uses the following notation to represent an octet or byte:

```

+---+---+---+---+---+---+
|7|6|5|4|3|2|1|0|
+---+---+---+---+---+---+

```

In this notation, the leftmost bit (bit 7) is the most significant bit ("MSB") and the rightmost bit (bit 0) is the least significant bit ("LSB").

Streams of bytes are ordered per lines of 4 bytes each as follows:

```

0...2.....7.....15.....23.....31
+---+---+---+---+---+---+---+---+---+---+---+---+---+---+---+---+
| first byte |           |           | 4th byte |
+---+---+---+---+---+---+---+---+---+---+---+---+---+---+---+---+
-----stream----->>>>

```

In this representation, the byte that comes first in the stream is on the left. The bit on the extreme left is the MSB of the first byte; the bit on the extreme right is the LSB of the 4th byte.

9.3 Mapping of the RTPS Types

9.3.1 The Globally Unique Identifier (GUID)

The GUID is an attribute present in all RTPS Entities that uniquely identifies them within the DDS domain (see Section 8.2.4.1). The PIM defines the GUID as composed of a *GuidPrefix_t* capable of holding 12 bytes, and an *EntityId_t* capable of holding 4 bytes. This section defines how the PSM maps those structures.

9.3.1.1 Mapping of the GuidPrefix_t

The PSM maps the *GuidPrefix_t* to the following structure:

```
typedef octet[12] GuidPrefix_t;
```

The reserved constant GUIDPREFIX_UNKNOWN defined by the PIM is mapped to:

```
#define GUIDPREFIX_UNKNOWN {0x00, 0x00, 0x00, 0x00, 0x00, 0x00, 0x00, 0x00, 0x00, 0x00, 0x00, 0x00}
```

9.3.1.2 Mapping of the EntityId_t

Section 8.2.4.3 states that the *EntityId_t* is the unique identification of the *Endpoint* within the *Participant*.

The PSM maps the *EntityId_t* to the following structure:

```
struct {
    octet[3] entityKey;
    octet entityKind;
} EntityId_t;
```

The reserved constant ENTITYID_UNKNOWN defined by the PIM is mapped to:

```
#define ENTITYID_UNKNOWN {0x00, 0x00, 0x00, 0x00}
```

The *entityKind* field within *EntityId_t* encodes the kind of *Entity* (*Participant*, *Reader*, *Writer*) and whether the *Entity* is a built-in *Entity* (fully pre-defined by the Protocol, automatically instantiated), a user-defined *Entity* (defined by the Protocol, but instantiated by the user only as needed by the application) or a vendor-specific *Entity* (defined by a vendor-specific extension to the Protocol, can therefore be ignored by another vendor's implementation).

When not pre-defined (see below), the *entityKey* field within the *EntityId_t* can be chosen arbitrarily by the middleware implementation as long as the resulting *EntityId_t* is unique within the *Participant*.

The information on whether the object is a built-in entity, a vendor-specific entity, or a user-defined entity is encoded in the two most-significant bits of the *entityKind*. These two bits are set to:

- '00' for user-defined entities.
- '11' for built-in entities.
- '01' for vendor-specific entities.

The information on the kind of *Entity* is encoded in the last six bits of the *entityKind* field. Table 9.1 provides a complete list of the possible values of the *entityKind* supported in version 2.1 of the protocol. These are fixed in this major version (2) of the protocol. New *entity Kinds* may be added in higher minor versions of the protocol in order to extend the model with new kinds of *Entities*.

Table 9.1 - entityKind octet of an EntityId_t

Kind of Entity	User-defined Entity	Built-in Entity
unknown	0x00	0xc0
Participant	N/A	0xc1
Writer (with Key)	0x02	0xc2
Writer (no Key)	0x03	0xc3
Reader (no Key)	0x04	0xc4
Reader (with Key)	0x07	0xc7

9.3.1.3 Predefined EntityIds

As mentioned above, the entity IDs for built-in entities are fully predefined by the RTPS Protocol.

The PIM specifies that the *EntityId_t* of a *Participant* has the pre-defined value ENTITYID_PARTICIPANT (Section 8.2.4.2). The corresponding PSM mapping of all pre-defined *Entity* IDs appears in Table 9.2. The meaning of these *Entity* IDs cannot change in this major version (2) of the protocol, but future minor versions may add additional reserved *Entity* IDs.

Table 9.2 - EntityId_t values fully predefined by the RTPS Protocol

Entity	Corresponding value for entityId_t (NAME = value)
participant	ENTITYID_PARTICIPANT = {00,00,01,c1}
SEDPbuiltinTopicWriter	ENTITYID_SEDP_BUILTIN_TOPIC_WRITER = {00,00,02,c2}

Table 9.2 - EntityId_t values fully predefined by the RTPS Protocol

Entity	Corresponding value for entityId_t (NAME = value)
SEDPbuiltinTopicReader	ENTITYID_SEDP_BUILTIN_TOPIC_READER = {00,00,02,c7}
SEDPbuiltinPublicationsWriter	ENTITYID_SEDP_BUILTIN_PUBLICATIONS_WRITER = {00,00,03,c2}
SEDPbuiltinPublicationsReader	ENTITYID_SEDP_BUILTIN_PUBLICATIONS_READER = {00,00,03,c7}
SEDPbuiltinSubscriptionsWriter	ENTITYID_SEDP_BUILTIN_SUBSCRIPTIONS_WRITER = {00,00,04,c2}
SEDPbuiltinSubscriptionsReader	ENTITYID_SEDP_BUILTIN_SUBSCRIPTIONS_READER = {00,00,04,c7}
SPDPbuiltinParticipantWriter	ENTITYID_SPDP_BUILTIN_PARTICIPANT_WRITER = {00,01,00,c2}
SPDPbuiltinSdpParticipantReader	ENTITYID_SPDP_BUILTIN_PARTICIPANT_READER = {00,01,00,c7}
BuiltinParticipantMessageWriter	ENTITYID_P2P_BUILTIN_PARTICIPANT_MESSAGE_WRITER = {00,02,00,C2}
BuiltinParticipantMessageReader	ENTITYID_P2P_BUILTIN_PARTICIPANT_MESSAGE_READER = {00,02,00,C7}

9.3.1.4 Deprecated EntityIds in version 2.1 of the Protocol

The Discovery Protocol used in version 2.1 of the protocol deprecates the EntityIds shown in Table 9.3. These EntityIds should not be used by future versions of the protocol unless they are used with the same meaning as in versions prior to 2.1. Implementations that wish to discover earlier versions should utilize these EntityIds.

Table 9.3 - Deprecated EntityIds in version 2.1 of the protocol

Entity	Corresponding entityId
Client	0x05
Server	0x06
writerApplications	{00,00,01,c2}
readerApplications	{00,00,01,c7}
writerClients	{00,00,05,c2}
readerClients	{00,00,05,c7}
writerServices	{00,00,06,c2}
readerServices	{00,00,06,c7}
writerManagers	{00,00,07,c2}
readerManagers	{00,00,07,c7}
writerApplicationsSelf	{00,00,08,c2}

9.3.1.5 Mapping of the GUID_t

The PSM maps the *GUID_t* to the following structure:

```
typedef struct {
    GuidPrefix_t guidPrefix;
    EntityId_t entityId;
} GUID_t;
```

The reserved constant GUID_UNKNOWN defined by the PIM is mapped to:

```
#define GUID_UNKNOWN{ GUIDPREFIX_UNKNOWN, ENTITYID_UNKNOWN }
```

9.3.2 Mapping of the Types that Appear Within Submessages or Built-in Topic Data

Table 9.4 specifies the PSM mapping of those types introduced by the PIM that appear within messages sent by the protocol. There is no need to map the types that are used exclusively by the virtual machine, but do not appear in the messages.

Table 9.4 - PSM mapping of the value types that appear on the wire

Type	PSM Mapping
<i>Time_t</i>	<p>Mapping of the type</p> <pre>struct { long seconds; // time in seconds unsigned long fraction; // time in sec/2^32 } Time_t;</pre> <p>The representation of the time is the one defined by the IETF Network Time Protocol (NTP) Standard (IETF RFC 1305). In this representation, time is expressed in seconds and fraction of seconds using the formula:</p> $\text{time} = \text{seconds} + (\text{fraction} / 2^{(32)})$ <p>Mapping of the reserved values:</p> <pre>#define TIME_ZERO {0, 0} #define TIME_INVALID {-1, 0xffffffff} #define TIME_INFINITE {0x7fffffff, 0xffffffff}</pre>
<i>VendorId_t</i>	<p>Mapping of the type</p> <pre>struct { octet[2] vendorId; } VendorId_t;</pre> <p>Mapping of the reserved values:</p> <pre>#define VENDORID_UNKNOWN {0,0}</pre>

Table 9.4 - PSM mapping of the value types that appear on the wire

Type	PSM Mapping
<i>SequenceNumber_t</i>	<p>Mapping of the type</p> <pre> struct { long high; unsigned long low; } SequenceNumber_t; </pre> <p>Using this structure, the 64-bit sequence number is:</p> $seq_num = high * 2^{32} + low$ <p>Mapping of the reserved values:</p> <pre> #define SEQUENCENUMBER_UNKNOWN {-1,0} </pre>
<i>FragmentNumber_t</i>	<p>Mapping of the type</p> <pre> struct { unsigned long value; } FragmentNumber_t; </pre>
<i>Locator_t</i>	<p>Mapping of the type</p> <pre> struct { long kind; unsigned long port; octet[16] address; } Locator_t; </pre> <p>If the <i>Locator_t kind</i> is <i>LOCATOR_KIND_UDPv4</i>, the <i>address</i> contains an IPv4 address. In this case the leading 12 octets of the address must be zero. The last 4 octets are used to store the IPv4 address. The mapping between the dot-notation “a.b.c.d” of an IPv4 address and its representation in the <i>address</i> field of a <i>Locator_t</i> is:</p> $address = (0,0,0,0,0,0,0,0,0,0,0,0,0,0,a,b,c,d)$ <p>If the <i>Locator_t kind</i> is <i>LOCATOR_KIND_UDPv6</i>, the <i>address</i> contains an IPv6 address. IPv6 addresses typically use a shorthand hexadecimal notation that maps one-to-one to the 16 octets in the <i>address</i> field. For example the representation of the IPv6 address “FF00:4501:0:0:0:0:32” is:</p> $address = (0xff,0,0x45,0x01,0,0,0,0,0,0,0,0,0,0,0,0x32)$ <p>Mapping of the reserved values:</p> <pre> #define LOCATOR_INVALID \ {LOCATOR_KIND_INVALID, LOCATOR_PORT_INVALID, LOCATOR_ADDRESS_INVALID} #define LOCATOR_KIND_INVALID -1 #define LOCATOR_ADDRESS_INVALID {0,0,0,0,0,0,0,0,0,0,0,0,0,0,0,0} #define LOCATOR_PORT_INVALID 0 #define LOCATOR_KIND_RESERVED 0 #define LOCATOR_KIND_UDPv4 1 #define LOCATOR_KIND_UDPv6 2 </pre>

Table 9.4 - PSM mapping of the value types that appear on the wire

Type	PSM Mapping
<i>TopicKind_t</i>	<p>Mapping of the type</p> <pre>struct { long value; } TopicKind_t;</pre> <p>Mapping of the reserved values:</p> <pre>#define NO_KEY 1 #define WITH_KEY 2</pre>
<i>ReliabilityKind_t</i>	<p>Mapping of the type</p> <pre>struct { long value; } ReliabilityKind_t;</pre> <p>Mapping of the reserved values:</p> <pre>#define BEST_EFFORT 1 #define RELIABLE 3</pre>
<i>Count_t</i>	<p>Mapping of the type</p> <pre>struct { long value; } Count_t;</pre>
<i>ProtocolVersion_t</i>	<p>Mapping of the type</p> <pre>typedef struct { octet major; octet minor; } ProtocolVersion_t;</pre> <p>Mapping of the reserved values:</p> <pre>#define PROTOCOLVERSION_1_0 {1,0} #define PROTOCOLVERSION_1_1 {1,1} #define PROTOCOLVERSION_2_0 {2,0} #define PROTOCOLVERSION_2_1 {2,1} #define PROTOCOLVERSION_{2,1}PROTOCOLVERSION_2_1</pre> <p>The Implementations following this version of the document implement protocol version 2.1 (major = 2, minor = 1).</p>
<i><u>KeyHash_t</u></i>	<p>Mapping of the type</p> <pre>struct { octet[16] value; } KeyHash_t;</pre>

Table 9.4 - PSM mapping of the value types that appear on the wire

Type	PSM Mapping
<i>StatusInfo_t</i>	<p>Mapping of the type</p> <pre> struct { octet[4] value; } StatusInfo_t; </pre>
<i>KeyHashPrefix_t</i>	<p>Mapping of the type</p> <pre> struct { octet[12] value; } KeyHashPrefix_t; </pre>
<i>KeyHashSuffix_t</i>	<p>Mapping of the type</p> <pre> struct { octet[4] value; } KeyHashSuffix_t; </pre>
<i>ParameterId_t</i>	<p>Mapping of the type</p> <pre> struct { short value; } ParameterId_t; </pre>
<i>ContentFilterProperty_t</i>	<p>Mapping of the type</p> <pre> typedef struct { string<256> contentFilteredTopicName; string<256> relatedTopicName; string<256> filterClassName; string filterExpression; sequence<string> expressionParameters; } ContentFilterProperty_t; </pre>
<i>ContentFilterInfo_t</i>	<p>Mapping of the type</p> <pre> typedef struct { FilterResult_t filterResult; sequence<FilterSignature_t> filterSignatures; } ContentFilterInfo_t; </pre> <p>with</p> <pre> typedef sequence<long> FilterResult_t; typedef long[4] FilterSignature_t; </pre>
<i>Property_t</i>	<pre> struct { string name; string value; } Property_t; </pre>
<i>EntityName_t</i>	<pre> struct { string name; } EntityName_t; </pre>

Table 9.4 - PSM mapping of the value types that appear on the wire

Type	PSM Mapping
<i>OriginalWriterInfo_t</i>	<pre> struct { GUID_t originalWriterGUID; SequenceNumber_t originalWriterSN; ParameterList originalWriterQos; } OriginalWriterInfo_t; </pre>
<i>BuiltinEndpointSet_t</i>	<p>Mapping of the type</p> <pre> typedef unsigned long BuiltinEndpointSet_t; where #define DISC_BUILTIN_ENDPOINT_PARTICIPANT_ANNOUNCER 0x00000001 << 0; #define DISC_BUILTIN_ENDPOINT_PARTICIPANT_DETECTOR 0x00000001 << 1; #define DISC_BUILTIN_ENDPOINT_PUBLICATION_ANNOUNCER 0x00000001 << 2; #define DISC_BUILTIN_ENDPOINT_PUBLICATION_DETECTOR 0x00000001 << 3; #define DISC_BUILTIN_ENDPOINT_SUBSCRIPTION_ANNOUNCER 0x00000001 << 4; #define DISC_BUILTIN_ENDPOINT_SUBSCRIPTION_DETECTOR 0x00000001 << 5; #define DISC_BUILTIN_ENDPOINT_PARTICIPANT_PROXY_ANNOUNCER 0x00000001 << 6; #define DISC_BUILTIN_ENDPOINT_PARTICIPANT_PROXY_DETECTOR 0x00000001 << 7; #define DISC_BUILTIN_ENDPOINT_PARTICIPANT_STATE_ANNOUNCER 0x00000001 << 8; #define DISC_BUILTIN_ENDPOINT_PARTICIPANT_STATE_DETECTOR 0x00000001 << 9; #define BUILTIN_ENDPOINT_PARTICIPANT_MESSAGE_DATA_WRITER 0x00000001 << 10; #define BUILTIN_ENDPOINT_PARTICIPANT_MESSAGE_DATA_READER 0x00000001 << 11; </pre>

In addition to the types introduced by the PIM, the UDP PSM introduces the additional types listed in Table 9.5.

Table 9.5 - Additional types introduced by the UDP PSM

Type	Description and PSM Mapping
<i>LocatorUDIPv4_t</i>	<p>Description</p> <p>Specialization of <i>Locator_t</i> used to hold UDP IPv4 locators using a more compact representation. Equivalent to <i>Locator_t</i> with <i>kind</i> set to <i>LOCATOR_KIND_UDPv4</i>.</p> <p>Need only be able to hold an IPv4 address and a port number.</p> <p>The following values are reserved by the protocol:</p> <pre> LOCATORUDIPv4_INVALID </pre> <p>Mapping</p> <p>Mapping of the type</p> <pre> struct { unsigned long address; unsigned long port; } LocatorUDIPv4_t; </pre> <p>The mapping between the dot-notation “a.b.c.d” of an IPv4 address and its representation as an unsigned long is as follows:</p> $\text{address} = ((a * 256 + b) * 256) + c * 256 + d$ <p>Mapping of the reserved values:</p> <pre> #define LOCATORUDIPv4_INVALID {0, 0} </pre>

Following the CDR encoding, the wire representation of the **GuidPrefix** SubmessageElement is:

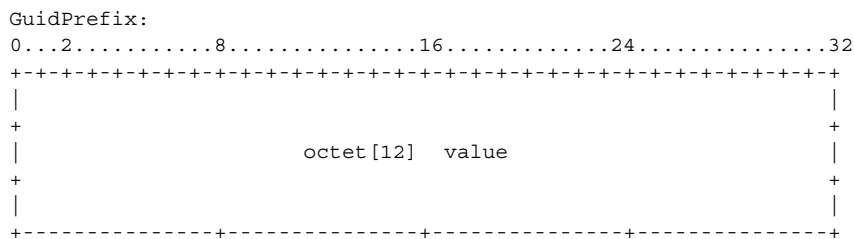

9.4.2.3 VendorId

The PSM mapping for the **VendorId** SubmessageElement defined in Section 8.3.5.2 is given by the following IDL definition:

```
typedef VendorId_t VendorId;
```

Following the CDR encoding, the wire representation of the **VendorId** SubmessageElement is:

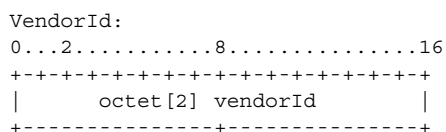

9.4.2.4 ProtocolVersion

The PSM mapping for the **ProtocolVersion** SubmessageElement defined in Section 8.3.5.3 is given by the following IDL definition:

```
typedef ProtocolVersion_t ProtocolVersion;
```

Following the CDR encoding, the wire representation of the **ProtocolVersion** SubmessageElement is:

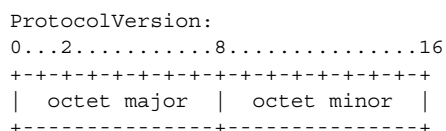

9.4.2.5 SequenceNumber

The PSM mapping for the **SequenceNumber** SubmessageElement defined in Section 8.3.5.4 is given by the following IDL definition:

```
typedef SequenceNumber_t SequenceNumber;
```

Following the CDR encoding, the wire representation of the **SequenceNumber** SubmessageElement is:

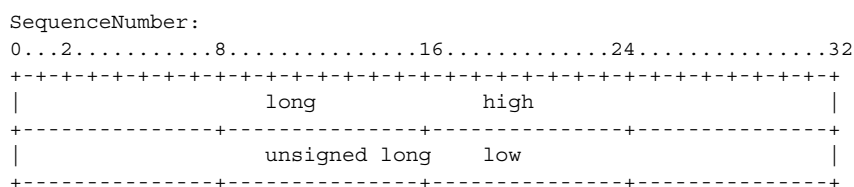

9.4.2.6 SequenceNumberSet

The PSM maps the **SequenceNumberSet** SubmessageElement defined in Section 8.3.5.5 to the following structure:

```
struct {
    SequenceNumber_t bitmapBase;
    sequence<long, 8> bitmap;
} SequenceNumberSet;
```

The above structure offers a compact representation encoding a set of up to 256 sequence numbers. The representation of the **SequenceNumberSet** includes the first sequence number in the set (*bitmapBase*) and a *bitmap* of up to 256 bits. The number of bits in the *bitmap* is denoted by numBits. The value of each bit in the *bitmap* indicates whether the SequenceNumber obtained by adding the offset of the bit to the *bitmapBase* is included (bit=1) or excluded (bit=0) from the **SequenceNumberSet**.

More precisely a **SequenceNumber** ‘*seqNum*’ belongs to the **SequenceNumberSet** ‘*seqNumSet*,’ if and only if the following two conditions apply:

```
seqNumSet.bitmapBase <= seqNum < seqNumSet.bitmapBase + seqNumSet.numBits
1  (bitmap[deltaN/32] & (1 << (31 - deltaN%32)) == (1 << (31 - deltaN%32))
```

where

```
deltaN = seqNum - seqNumSet.bitmapBase
```

A valid **SequenceNumberSet** must satisfy the following conditions:

- *bitmapBase* >= 1
- 0 < numBits <= 256
- there are M=(numBits+31)/32 longs containing the pertinent bits

This document uses the following notation for a specific bitmap:

```
bitmapBase/numBits:bitmap
```

In the *bitmap*, the bit corresponding to sequence number *bitmapBase* is on the left. The ending "0" bits can be represented as one "0."

For example, in *bitmap* “1234/12:00110”, *bitmapBase*=1234 and *numBits*=12. The bits apply as follows to the sequence numbers:

Table 9.6 - Example of bitmap: meaning of “1234/12:00110”

SequenceNumber	Bit
1234	0
1235	0
1236	1
1237	1
1238-1245	0

The wire representation of the **SequenceNumberSet** SubmessageElement is:

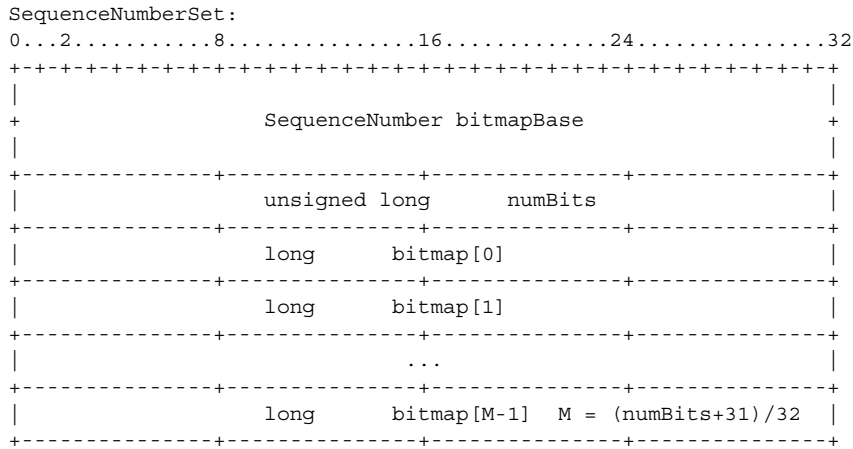

The *numBits* field encodes both the number of significant bits and the number of bitmap elements. Due to this optimization, this SubmessageElement does not follow strict CDR encoding.

9.4.2.7 FragmentNumber

The PSM mapping for the **FragmentNumber** SubmessageElement defined in Section 8.3.5.6 is given by the following IDL definition:

```
typedef FragmentNumber_t FragmentNumber;
```

Following the CDR encoding, the wire representation of the **FragmentNumber** SubmessageElement is:

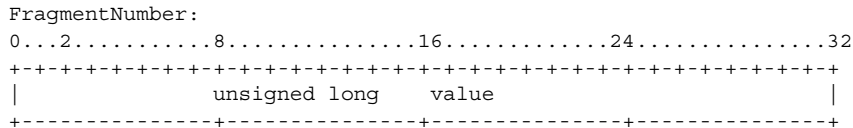

9.4.2.8 FragmentNumberSet

The PSM maps the **FragmentNumberSet** SubmessageElement defined in Section 8.3.5.7 to the following structure:

```
struct {
    FragmentNumber_t bitmapBase;
    sequence<long, 8> bitmap;
} FragmentNumberSet;
```

The above structure offers a compact representation encoding a set of up to 256 fragment numbers. The representation of the **FragmentNumberSet** includes the first fragment number in the set (*bitmapBase*) and a *bitmap* of up to 256 bits. The interpretation matches that of a **SequenceNumberSet**.

The wire representation of the **FragmentNumberSet** SubmessageElement is:

```

FragmentNumberSet
0...2.....8.....16.....24.....32
+---+---+---+---+---+---+---+---+---+---+---+---+---+---+---+---+
|               fragmentNumber  bitmapBase               |
+-----+-----+-----+-----+-----+-----+-----+-----+
|               unsigned long  numBits                    |
+-----+-----+-----+-----+-----+-----+-----+-----+
|               long           bitmap[0]                  |
+-----+-----+-----+-----+-----+-----+-----+-----+
|               long           bitmap[1]                  |
+-----+-----+-----+-----+-----+-----+-----+-----+
|               ...                                           |
+-----+-----+-----+-----+-----+-----+-----+-----+
|               long           bitmap[M-1]  M = (numBits+31)/32 |
+-----+-----+-----+-----+-----+-----+-----+-----+

```

The *numBits* field encodes both the number of significant bits and the number of bitmap elements. Due to this optimization, this SubmessageElement does not follow strict CDR encoding.

9.4.2.9 Timestamp

The PSM mapping for the **Timestamp** SubmessageElement defined in Section 8.3.5.8 is given by the following IDL definition:

```
typedef Time_t Timestamp;
```

Following the CDR encoding, the wire representation of the **Timestamp** SubmessageElement is:

```

Timestamp:
0...2.....8.....16.....24.....31
+---+---+---+---+---+---+---+---+---+---+---+---+---+---+---+---+
|               long           seconds                    |
+-----+-----+-----+-----+-----+-----+-----+-----+
|               unsigned long   fraction                  |
+-----+-----+-----+-----+-----+-----+-----+-----+

```

9.4.2.10 LocatorList

The PSM mapping for the **LocatorList** SubmessageElement defined in Section 8.3.5.11 is given by the following IDL definition:

```
typedef sequence<Locator_t, 8> LocatorList;
```

Following the CDR encoding, the wire representation of the **LocatorList** SubmessageElement is:

```

LocatorList:
0...2.....8.....16.....24.....31
+---+---+---+---+---+---+---+---+---+---+---+---+---+---+---+---+
|               unsigned long   numLocators                |
+-----+-----+-----+-----+-----+-----+-----+-----+
|               Locator_t       locator_1                  |
~               ...                                           ~
|               Locator_t       locator_numLocators        |
+-----+-----+-----+-----+-----+-----+-----+-----+

```

Where each *Locator_t* has the following wire representation:

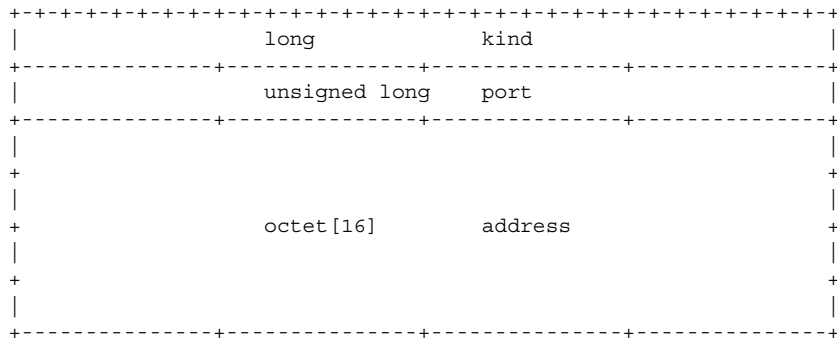

9.4.2.11 ParameterList

A **ParameterList** contains a list of **Parameters**, terminated with a sentinel. Each **Parameter** within the **ParameterList** starts aligned on a 4-byte boundary with respect to the start of the **ParameterList**.

The IDL representation for each **Parameter** is:

```

typedef short ParameterId_t
struct Parameter {
    ParameterId_t parameterId;
    short length;
    octet value[length];
};

```

The *parameterId* identifies the type of parameter.

The *length* encodes the number of octets following the *length* to reach the ID of the next parameter (or the ID of the sentinel). Because every *parameterId* starts on a 4-byte boundary, the *length* is always a multiple of four.

The *value* contains the CDR encapsulation of the Parameter type that corresponds to the specified *parameterId*. For alignment purposes, the CDR stream is logically reset for each parameter (i.e., no initial padding is required).

The **ParameterList** may contain multiple Parameters with the same value for the *parameterId*. This is used to provide a collection of values for that kind of Parameter.

The use of **ParameterList** encapsulation makes it possible to extend the protocol and introduce new parameters and still be able to preserve interoperability with earlier versions of the protocol.

The wire representation for the **ParameterList** is:

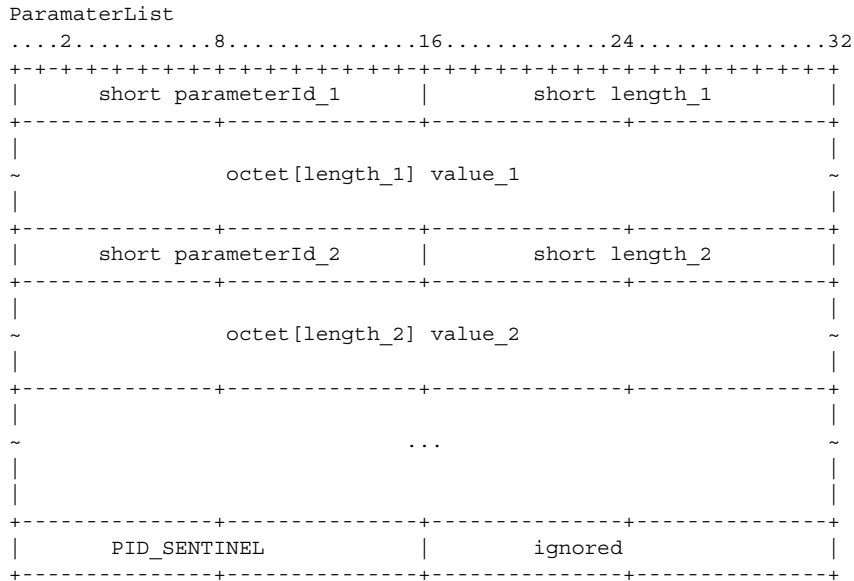

There are two predefined values of the *parameterId* used for the encapsulation:

```

#define PID_PAD (0)
#define PID_SENTINEL (1)

```

The PID_SENTINEL is used to terminate the parameter list and its length is ignored. The PID_PAD is used to enforce alignment of the parameter that follows and its length can be anything (as long as it is a multiple of 4).

The complete set of possible values for the *parameterId* in version 2.1 of the protocol appears in Section 9.6.3.

9.4.2.12 SerializedDataPayload

~~A SerializedDataSubmessageElement contains the serialized representation of the value of an application-defined data-object.~~ A SerializedPayloadSubmessageElement contains the serialized representation of either value of an application-defined data-object or the value of the key that uniquely identifies the data-object. The specification of the process used to encapsulate the application-level data-type into a serialized byte-stream is not strictly part of the RTPS protocol. For the purpose of interoperability, all implementations must however use a consistent representation (See Chapter 10, 'Data Encapsulation').

The wire representation for the **SerializedDataPayload** is:

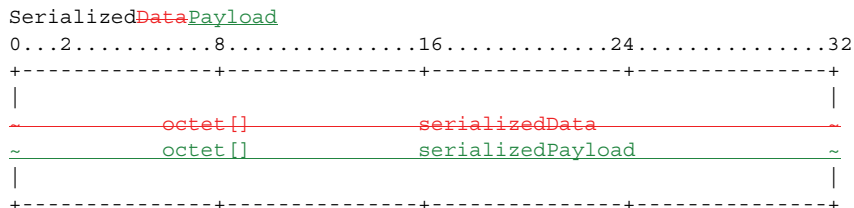

Note that when using CDR, primitive types must be aligned to their length. For example, a long must start on a 4-byte boundary. The boundaries are counted from the start of the CDR stream.

9.4.2.13 Count

The PSM maps the **Count** SubmessageElement defined in Section 8.3.5.10 to the structure:

```
typedef Count_t Count;
```

Following the CDR encoding, the wire representation of the **Count** SubmessageElement is:

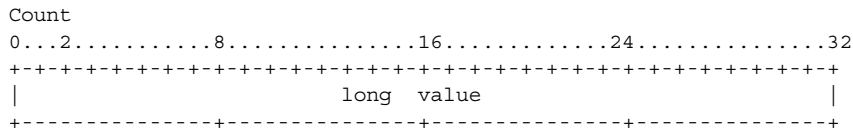

9.4.2.14 KeyHashPrefix

~~The PSM mapping for the **KeyHashPrefix** SubmessageElement defined in Section 8.3.5.10 is given by the following IDL definition:~~

```
typedef KeyHashPrefix_t KeyHashPrefix;
```

~~Following the CDR encoding, the wire representation of the **KeyHashPrefix** SubmessageElement is:~~

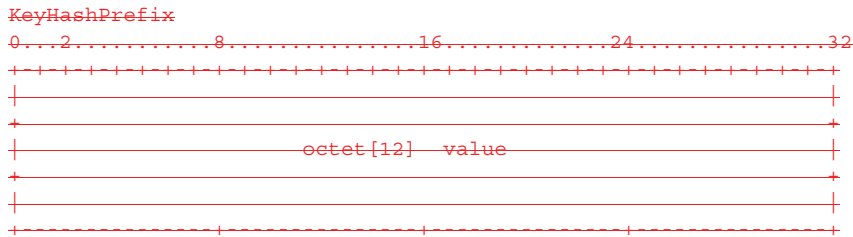

9.4.2.15 KeyHashSuffix

~~The PSM mapping for the **KeyHashSuffix** SubmessageElement defined in Section 8.3.5.11 is given by the following IDL definition:~~

```
typedef KeyHashSuffix_t KeyHashSuffix;
```

~~Following the CDR encoding, the wire representation of the **KeyHashSuffix** SubmessageElement is:~~

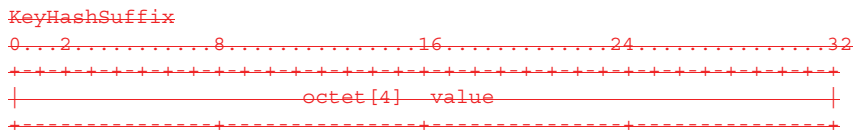

9.4.3 Additional SubmessageElements

In addition to the SubmessageElements introduced by the PIM, the UDP PSM introduces the following additional SubmessageElements.

9.4.3.1 LocatorUDpv4

The **LocatorUDpv4** SubmessageElement is identical to a **LocatorList** SubmessageElement containing a single locator of kind `LOCATOR_KIND_UDPv4`. **LocatorUDpv4** is introduced to provide a more compact representation when using UDP on IPv4.

Table 9.7 - Structure of the LocatorUDpv4 SubmessageElement

field	type	meaning
<i>value</i>	LocatorUDpv4_t	A single IPv4 address and port.

The PSM maps the **LocatorUDpv4** SubmessageElement to the structure:

```
typedef LocatorUDpv4_t LocatorUDpv4;
```

Following the CDR encoding, the wire representation of the **LocatorUDpv4** SubmessageElement is:

```
LocatorUDpv4:
0...2.....8.....16.....24.....32
+++++
|                unsigned long   address                |
+-----+
|                unsigned long   port                    |
+-----+
```

9.4.4 Mapping of the RTPS Header

Section 8.3.7 in the PIM specifies that all messages should include a leading RTPS Header. The PSM mapping of the RTPS Header is shown below:

```
Header:
0...2.....8.....16.....24.....32
+++++
|   'R'   |   'T'   |   'P'   |   'S'   |
+-----+
| ProtocolVersion version | VendorId vendorId |
+-----+
|
+
|           GuidPrefix      guidPrefix
+
|
+-----+
```

The structure of the Header cannot change in this major version (2) of the protocol.

9.4.5 Mapping of the RTPS Submessages

9.4.5.1 Submessage Header

Section 8.3.3.2 in the PIM defined the structure of all Submessages as composed of a leading **SubmessageHeader** followed by a variable number of **SubmessageElements**.

The PSM maps the **SubmessageHeader** into the following structure:

```

struct {
    octet submessageId;
    octet flags;
    unsigned short submessageLength; /* octetsToNextHeader */
} SubmessageHeader;

```

With the byte stream representation defined in Section 9.2.3, the `submessageLength` is defined as the number of octets from the start of the contents of the Submessage to the start of the next Submessage header. Given this definition, the remainder of the UDP PSM will refer to `submessageLength` as *octetsToNextHeader*. See also Section 9.4.5.1.3.

Following the CDR encoding, the wire representation of the **SubmessageHeader** is shown below:

```

SubmessageHeader:
0...2.....8.....16.....24.....32
+--+--+--+--+--+--+--+--+--+--+--+--+--+--+--+--+--+--+--+--+--+--+
| submessageId |      flags |E|  ushort octetsToNextHeader  |
+-----+-----+-----+-----+-----+-----+-----+-----+
|
|               following are the                          |
~               contents of Submessage                       ~
|
+-----+-----+-----+-----+-----+-----+-----+-----+

```

This general structure cannot change in this major version (2) of the protocol.

The following sections discuss each member of the **SubmessageHeader** in more detail.

9.4.5.1.1 SubmessageId

This octet identifies the kind of **Submessage**. Submessages with IDs 0x00 to 0x7f (inclusive) are protocol-specific. They are defined as part of the RTPS protocol. Version 2.1 defines the following Submessages:

```

enum SubmessageKind {
    PAD                = 0x01, /* Pad */
    DATA                = 0x02, /* Data */
    NOKEY_DATA          = 0x03, /* NoKeyData */
    ACKNACK            = 0x06, /* AckNack */
    HEARTBEAT         = 0x07, /* Heartbeat */
    GAP               = 0x08, /* Gap */
    INFO_TS           = 0x09, /* InfoTimestamp */
    INFO_SRC          = 0x0c, /* InfoSource */
    INFO_REPLY_IP4    = 0x0d, /* InfoReplyIp4 */
    INFO_DST          = 0x0e, /* InfoDestination */
    INFO_REPLY        = 0x0f, /* InfoReply */
    DATA_FRAG          = 0x10, /* DataFrag */
    NOKEY_DATA_FRAG    = 0x11, /* NoKeyDataFrag */
    NACK_FRAG         = 0x12, /* NackFrag */
    HEARTBEAT_FRAG    = 0x13, /* HeartbeatFrag */
    DATA              = 0x15, /* Data */
    DATA_FRAG        = 0x16, /* DataFrag */
};

```

The meaning of the Submessage IDs cannot be modified in this major version (2). Additional Submessages can be added in higher minor versions. Submessages with ID's 0x80 to 0xff (inclusive) are vendor-specific; they will not be defined by future versions of the protocol. Their interpretation is dependent on the *vendorId* that is current when the Submessage is encountered. ~~The current list of vendorId's is provided in TODO.~~

9.4.5.1.2 flags

Section 8.3.3.2 in the PIM defines the *EndiannessFlag* as a flag present in all Submessages that indicates the endianness used to encode the Submessage. The PSM maps the *EndiannessFlag* flag into the least-significant bit (LSB) of the *flags*. This bit is therefore always present in all **Submessages** and represents the endianness used to encode the information in the **Submessage**. The *EndiannessFlag* is represented with the literal 'E'. E=0 means big-endian, E=1 means little-endian.

The value of the *EndiannessFlag* can be obtained from the expression:

```
E = SubmessageHeader.flags & 0x01
```

Other bits in the *flags* have interpretations that depend on the type of **Submessage**.

In the following descriptions of the **Submessages**, the character 'X' is used to indicate a flag that is unused in version 2.1 of the protocol. Implementations of RTPS version 2.1 should set these to zero when sending and ignore these when receiving. Higher minor versions of the protocol can use these flags.

9.4.5.1.3 octetsToNextHeader

The representation of this field is a CDR unsigned short (ushort).

In case *octetsToNextHeader* > 0, it is the number of octets from the first octet of the contents of the Submessage until the first octet of the header of the next **Submessage** (in case the **Submessage** is not the last **Submessage** in the **Message**) OR it is the number of octets remaining in the **Message** (in case the **Submessage** is the last **Submessage** in the **Message**). An interpreter of the **Message** can distinguish these two cases as it knows the total length of the **Message**.

In case *octetsToNextHeader*==0 and the kind of Submessage is NOT PAD or INFO_TS, the **Submessage** is the last **Submessage** in the **Message** and extends up to the end of the **Message**. This makes it possible to send Submessages larger than 64k (the size that can be stored in the *octetsToNextHeader* field), provided they are the last **Submessage** in the **Message**.

In case the *octetsToNextHeader*==0 and the kind of Submessage is PAD or INFO_TS, the next **Submessage** header starts immediately after the current **Submessage** header OR the PAD or INFO_TS is the last **Submessage** in the **Message**.

9.4.5.2 AckNack Submessage

Section 8.3.7.1 in the PIM defines the logical contents of the **AckNack** Submessage. The PSM maps the **AckNack** Submessage into the following wire representation:

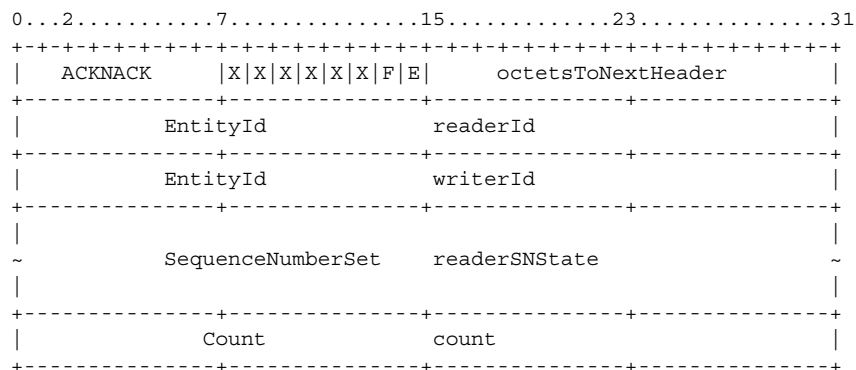

9.4.5.2.1 Flags in the Submessage Header

In addition to the *EndiannessFlag*, The **AckNack** Submessage introduces the *FinalFlag* (“Content” on page 45). The PSM maps the *FinalFlag* flag into the 2nd least-significant bit (LSB) of the flags.

The *FinalFlag* is represented with the literal ‘F’. F=1 means the reader does not require a response from the writer. F=0 means the writer must respond to the AckNack message.

The value of the *FinalFlag* can be obtained from the expression:

```
F = SubmessageHeader.flags & 0x02
```

9.4.5.3 ~~NoKeyData Submessage~~

~~Section in the PIM defines the logical contents of the **NoKeyData** Submessage. The PSM maps the **NoKeyData** Submessage into the following wire representation:~~



9.4.5.3.1 ~~Flags in the Submessage Header~~

~~In addition to the *EndiannessFlag*, The **NoKeyData** Submessage introduces the *InlineQosFlag* and *DataFlag* (see “Contents” on page 48). The PSM maps these flags respectively into the 2nd and 3rd least significant bits (LSB) of the flags:~~

~~The *InlineQosFlag* is represented with the literal ‘Q’. Q=1 means that the **NoKeyData** Submessage contains the inlineQos SubmessageElement.~~

~~The value of the *InlineQosFlag* can be obtained from the expression:~~

```
Q = SubmessageHeader.flags & 0x02
```

~~The *DataFlag* is represented with the literal ‘D.’ D=1 means that the **NoKeyData** Submessage contains the serializedData SubmessageElement.~~

~~The value of the *DataFlag* can be obtained from the expression:~~

```
D = SubmessageHeader.flags & 0x04
```

9.4.5.4 NoKeyDataFrag-Submessage

Section 8.3.7.2 in the PIM defines the logical contents of the **NoKeyDataFrag**-Submessage. The PSM maps the **NoKeyDataFrag**-Submessage into the following wire representation:

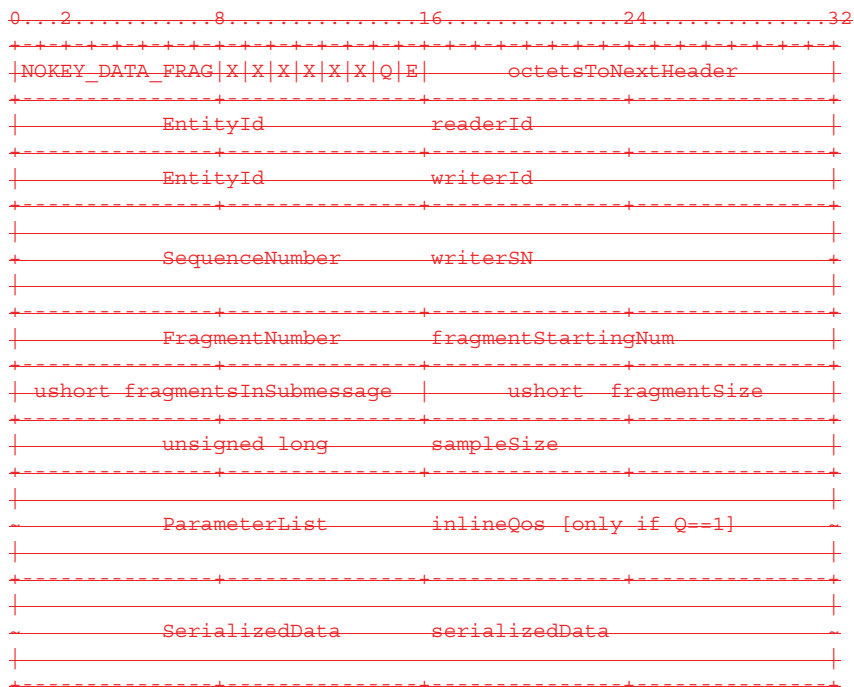

9.4.5.4.1 Flags in the Submessage Header

In addition to the *EndiannessFlag*, The **NoKeyDataFrag**-Submessage introduces the *InlineQosFlag*. The PSM maps this additional flags into the 2nd least significant bit (LSB) of the flags.

The *InlineQosFlag* is represented with the literal 'Q'. Q=1 means that the **NoKeyDataFrag**-Submessage contains the *inlineQos*-SubmessageElement.

The value of the *InlineQosFlag* can be obtained from the expression:

$$Q = \text{SubmessageHeader.flags} \& 0x02$$

9.4.5.5 Data Submessage

Section 8.3.7.2 in the PIM defines the logical contents of the **Data** Submessage. The PSM maps the **Data** Submessage into the following wire representation:

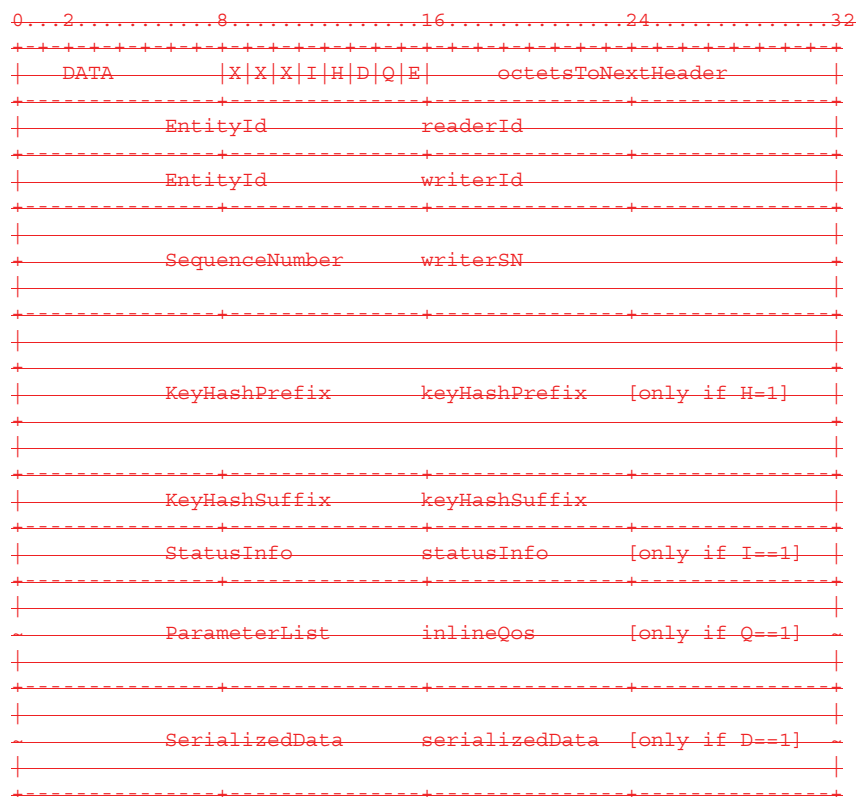
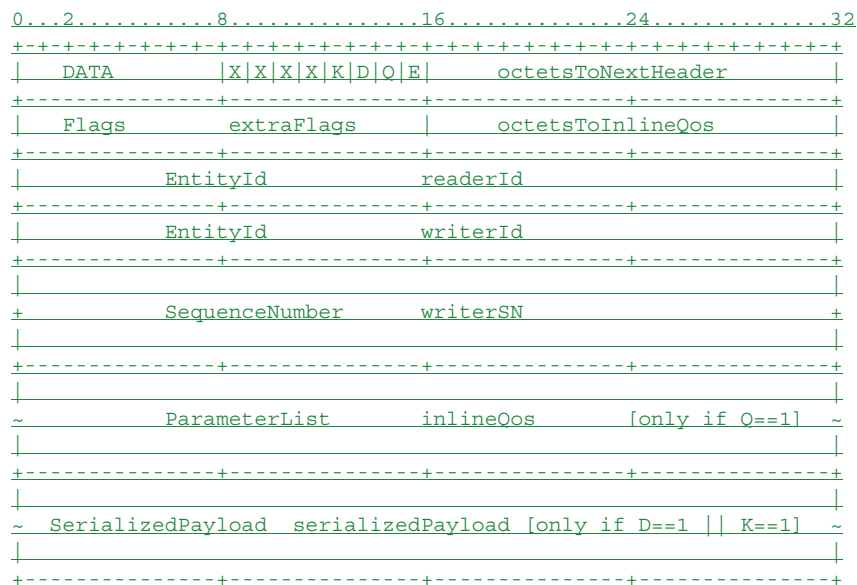

where

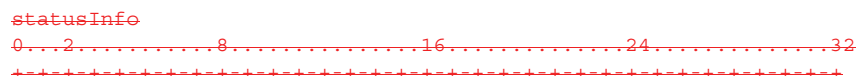

The *UnregisteredFlag* is represented with the literal ‘U’. U=0 means that the *Writer* plans to provide further information on the Data-Object. U=1 means the *Writer* will not provide any further information on the Data-Object (or also, has “unregistered” the Data-Object). The value of the *UnregisteredFlag* can be obtained from the expression:

```
U = statusInfo & 0x02
```

The *StatusInfo* SubmessageElement can be omitted if all its flags are zero. It must only be included if any of its flags are non-zero.

9.4.5.5.2 *extraFlags*

The *extraFlags* field provides space for an additional 16 bits of flags beyond the 8 bits provided as in the submessage header. These additional bits will support evolution of the protocol without compromising backwards compatibility.

This version of the protocol should set all the bits in the *extraFlags* to zero.

9.4.5.5.3 *octetsToInlineQos*

The representation of this field is a CDR unsigned short (ushort).

The *octetsToInlineQos* field contains the number of octets starting from the first octet immediately following this field until the first octet of the *inlineQos* SubmessageElement. If the *inlineQos* SubmessageElement is not present (i.e. the *InlineQosFlag* is not set), then *octetsToInlineQos* contains the offset to the next field after the *inlineQos*.

Implementation of the protocol that are processing a received submessage should always use the *octetsToInlineQos* to skip any submessage headers it does not expect or understand and continue to process the *inlineQos* SubmessageElement (or the first submessage element that follows *inlineQos* if the *inlineQos* is not present). This rule is necessary so that the receiver will be able to interoperate with senders that use future versions of the protocol which may include additional submessage headers before the *inlineQos*.

9.4.5.6 DataFrag Submessage

Section 8.3.7.3 in the PIM defines the logical contents of the **DataFrag** Submessage. The PSM maps the **DataFrag** Submessage into the following wire representation:

-----+

9.4.5.9.1 Flags in the Submessage Header

The **HeartBeatFrag** Submessage introduces no other flags in addition to the *EndiannessFlag*.

9.4.5.10 InfoDestination Submessage

Section 8.3.7.7 in the PIM defines the logical contents of the **InfoDestination** Submessage. The PSM maps the **InfoDestination** Submessage into the following wire representation:

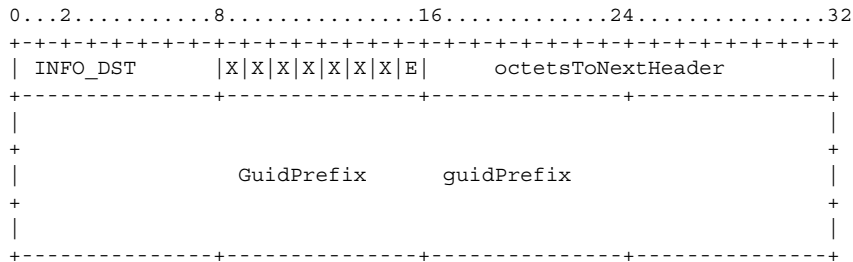

9.4.5.10.1 Flags in the Submessage Header

This Submessage has no flags in addition to the *EndiannessFlag*.

9.4.5.11 InfoReply Submessage

Section 8.3.7.8 in the PIM defines the logical contents of the **InfoReply** Submessage. The PSM maps the **InfoReply** Submessage into the following wire representation:

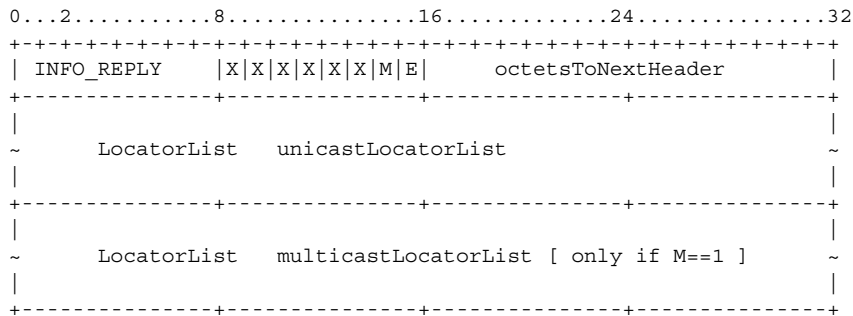

9.4.5.11.1 Flags in the Submessage Header

In addition to the *EndiannessFlag*, The **InfoReply** Submessage introduces the *MulticastFlag* (“Content” on page 45). The PSM maps the *MulticastFlag* flag into the 2nd least-significant bit (LSB) of the flags.

The *MulticastFlag* is represented with the literal ‘M’. M=1 means the **InfoReply** also includes a *multicastLocatorList*.

The value of the *MulticastFlag* can be obtained from the expression:

$$M = \text{SubmessageHeader.flags} \& 0x02$$

9.4.5.12 InfoSource Submessage

Section 8.3.7.9 in the PIM defines the logical contents of the **InfoSource** Submessage. The PSM maps the **InfoSource** Submessage into the following wire representation:

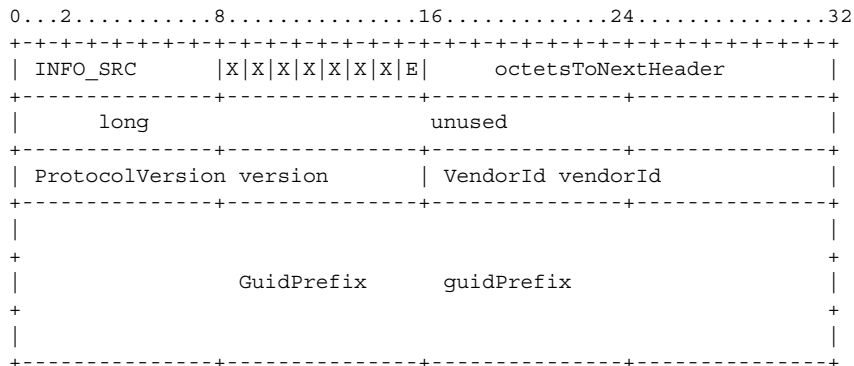

9.4.5.12.1 Flags in the Submessage Header

This Submessage has no flags in addition to the *EndiannessFlag*.

9.4.5.13 InfoTimestamp Submessage

Section 8.3.7.9.6 in the PIM defines the logical contents of the **InfoTimestamp** Submessage. The PSM maps the **InfoTimestamp** Submessage into the following wire representation:

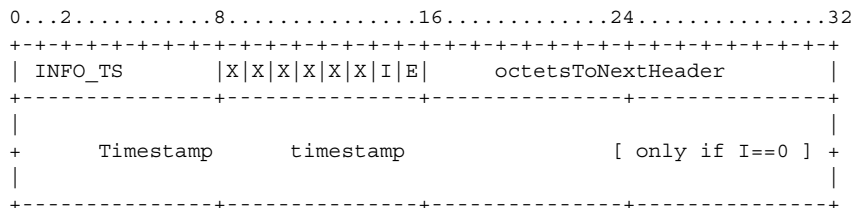

9.4.5.13.1 Flags in the Submessage Header

In addition to the *EndiannessFlag*, The **InfoTimestamp** Submessage introduces the *InvalidateFlag* (“Content” on page 45). The PSM maps the *InvalidateFlag* flag into the 2nd least-significant bit (LSB) of the flags.

The *InvalidateFlag* is represented with the literal ‘I’. I=0 means the **InfoTimestamp** also includes a *timestamp*. I=1 means subsequent Submessages should not be considered to have a valid timestamp.

The value of the *InvalidateFlag* can be obtained from the expression:

```
I = SubmessageHeader.flags & 0x02
```

9.4.5.14 Pad Submessage

Section 8.3.7.11 in the PIM defines the logical contents of the **Pad** Submessage. The PSM maps the **Pad** Submessage into the following wire representation:

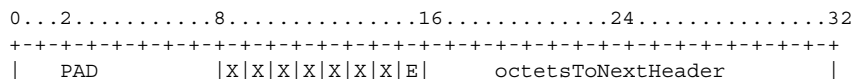

9.4.5.14.1 Flags in the Submessage Header

This Submessage has no flags in addition to the *EndiannessFlag*.

9.4.5.15 NackFrag Submessage

Section 8.3.7.10 in the PIM defines the logical contents of the **NackFrag** Submessage. The PSM maps the **NackFrag** Submessage into the following wire representation:

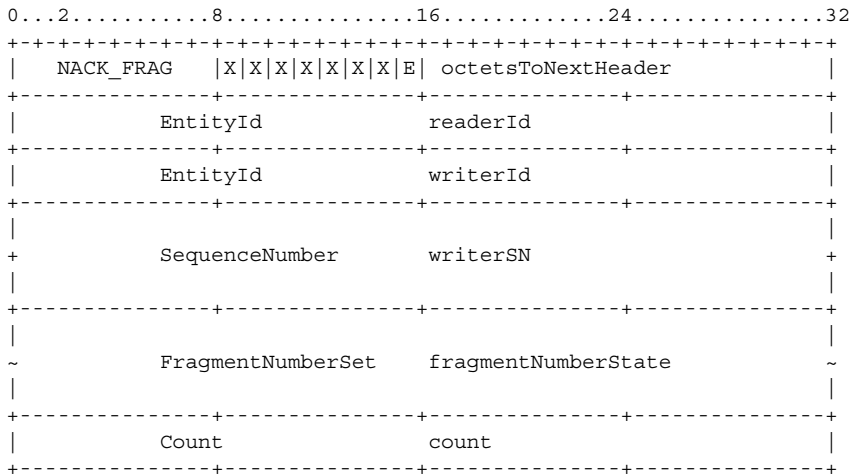

9.4.5.15.1 Flags in the Submessage Header

This Submessage has no flags in addition to the *EndiannessFlag*.

9.4.5.16 InfoReplyIp4 Submessage (PSM specific)

The **InfoReplyIp4** Submessage is an additional Submessage introduced by the UDP PSM.

Its use and interpretation are identical to those of an **InfoReply** Submessage containing a single unicast and possibly a single multicast locator, both of kind `LOCATOR_KIND_UDPv4`. It is provided for efficiency reasons and can be used instead of the **InfoReply** Submessage to provide a more compact representation.

The PSM maps the **InfoReplyIp4** Submessage into the following wire representation:

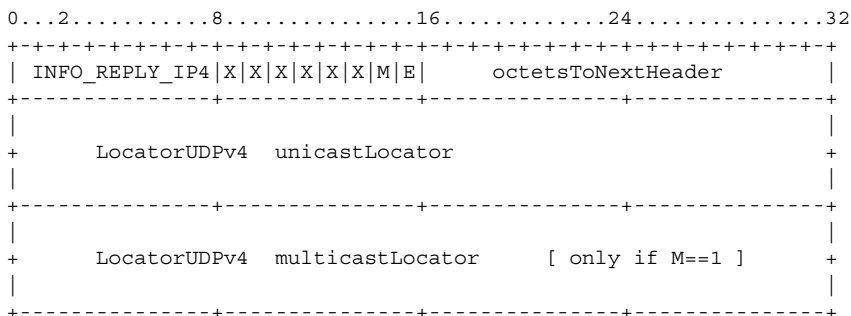

9.4.5.16.1 Flags in the Submessage Header

In addition to the *EndiannessFlag*, The **InfoReplyIp4** Submessage introduces the *MulticastFlag*. The PSM maps the *MulticastFlag* flag into the 2nd least-significant bit (LSB) of the flags.

The *MulticastFlag* is represented with the literal ‘M’. M=1 means the **InfoReplyIp4** also includes a *multicastRLocator*.

The value of the *MulticastFlag* can be obtained from the expression:

```
M = SubmessageHeader.flags & 0x02
```

9.5 RTPS Message Encapsulation

When RTPS is used over UDP/IP, a **Message** is the contents (payload) of exactly one UDP/IP Datagram.

9.6 Mapping of the RTPS Protocol

9.6.1 Default Locators

9.6.1.1 Discovery traffic

Discovery traffic is the traffic generated by the Participant and Endpoint Discovery Protocols. For the Simple Discovery Protocols (SPDP and SEDP), discovery traffic is the traffic exchanged between the built-in *Endpoints*.

The SPDP built-in *Endpoints* are configured using well-known ports (see Section 8.5.3.4). The UDP PSM maps these well-known ports to the port number expressions listed in Table 9.8.

Table 9.8 - Ports used by built-in Endpoints

Discovery traffic type	SPDP well-known port	Default port number expression
Multicast	SPDP_WELL_KNOWN_MULTICAST_PORT	PB + DG * <i>domainId</i> + d0
Unicast	SPDP_WELL_KNOWN_UNICAST_PORT	PB + DG * <i>domainId</i> + d1 + PG * <i>participantId</i>

where

```
domainId = DDS Domain identifier  
participantId = Participant identifier  
PB, DG, d0, d1 = tunable parameters (defined below)
```

The *domainId* and *participantId* identifiers are used to avoid port conflicts among *Participants* on the same node. Each *Participant* on the same node and in the same domain must use a unique *participantId*. In the case of multicast, all *Participants* in the same domain share the same port number, so the *participantId* identifier is not used in the port number expression.

To simplify the configuration of the SPDP, *participantId* values ideally start at 0 and are incremented for each additional *Participant* on the same node and in the same domain. That way, for a given domain, *Participants* can announce their presence to up to N remote *Participants* on a given node, by announcing to port numbers on that node corresponding to *participantId* 0 through N-1.

The default ports used by the SEDP built-in *Endpoints* match those used by the SPDP. If a node chooses not to use the default ports for the SEDP, it can include the new port numbers as part of the information exchanged during the SPDP.

9.6.1.2 User traffic

User traffic is the traffic exchanged between user-defined Endpoints (i.e., non built-in *Endpoints*). As such, it pertains to all the traffic that is not related to discovery. By default, user-defined *Endpoints* use the port number expressions listed in Table 9.9.

Table 9.9 - Ports used by user-defined Endpoints

User traffic type	Default port number expression
Multicast	$PB + DG * domainId + d2$
Unicast	$PB + DG * domainId + d3 + PG * participantId$

User-defined Endpoints may choose to not use the default ports. In that case, remote Endpoints obtain the port number as part of the information exchanged during the Simple Endpoint Discovery Protocol.

9.6.1.3 Default Port Numbers

The port number expressions use the following parameters:

```
DG = DomainId Gain
PG = ParticipantId Gain
PB = Port Base number
d0, d1, d2, d3 = additional offsets
```

Implementations must expose these parameters so they can be customized by the user.

In order to enable out-of-the-box interoperability, the following default values must be used:

```
PB = 7400
DG = 250
PG = 2
d0 = 0
d1 = 10
d2 = 1
d3 = 11
```

Given UDP port numbers are limited to 64K, the above defaults enables the use of about 230 domains with up to 120 *Participants* per node per domain.

9.6.1.4 Default Settings for the Simple Participant Discovery Protocol

When using the SPDP, each *Participant* sends announcements to a pre-configured list of locators. What ports to use when configuring these locators is discussed above. This section describes any remaining settings that are required to enable plug-and-play interoperability.

9.6.1.4.1 Default multicast address

In order to enable plug-and-play interoperability, the default pre-configured list of locators must include the following multicast locator (assuming UDPv4):

```
DefaultMulticastLocator = {LOCATOR_KIND_UDPv4, "239.255.0.1", PB + DG * domainId + d0}
```

All *Participants* must announce and listen on this multicast address.

```
SPDPbuiltinParticipantWriter.readerLocators CONTAINS DefaultMulticastLocator
SPDPbuiltinParticipantReader.multicastLocatorList CONTAINS DefaultMulticastLocator
```

9.6.1.4.2 Default announcement rate

The default rate by which SPDP periodic announcements are sent equals 30 seconds.

```
SPDPbuiltinParticipantWriter.resendPeriod = {30, 0};
```

9.6.2 Data representation for the built-in Endpoints

9.6.2.1 Data Representation for the ParticipantMessageData Built-in Endpoints

The Behavior module within the PIM (Section 8.4) defines the DataType *ParticipantMessageData*. This type is the logical content of the *BuiltinParticipantDataMessageWriter* and *BuiltinParticipantDataMessageReader* built-in Endpoints.

The PSM maps the *ParticipantMessageData* tpe into the following IDL:

```
struct ParticipantMessageData {
  KeyHashPrefix_t participantGuidPrefix;
  KeyHashSuffix_t kind;
  GuidPrefix_t participantGuidPrefix;
  octet [4] kind;
  sequence<octet> data;
};
```

~~The DDS key consists of both the *participantGuidPrefix* and the *kind* fields. On the wire, the *participantGuidPrefix* and the *kind* are not serialized as part of the *ParticipantMessageData* because they are already explicitly serialized as part of the Data Submessages (see Section 8.3.7.2).~~

The following values for the kind field are reserved by RTPS:

```
#define PARTICIPANT_MESSAGE_DATA_KIND_UNKNOWN {0x00, 0x00, 0x00, 0x00}
#define PARTICIPANT_MESSAGE_DATA_KIND_AUTOMATIC_LIVELINESS_UPDATE {0x00, 0x00, 0x00, 0x01}
#define PARTICIPANT_MESSAGE_DATA_KIND_MANUAL_LIVELINESS_UPDATE {0x00, 0x00, 0x00, 0x02}
```

RTPS also reserves for future use all values of the kind field where the most significant bit is not set. Therefore:

```
kind.value[0] & 0x80 == 0 // reserved by RTPS
kind.gd.value[0] & 0x80 == 1 // vendor specific kind
```

Implementations can decide the upper length of the data field but must be able to support at least 128 bytes.

Following the CDR encoding, the wire representation of the *ParticipantMessageData* structure is:

```
0...2.....8.....16.....24.....32
+--+--+--+--+--+--+--+--+--+--+--+--+--+--+--+--+--+--+--+--+--+--+
|                unsigned long      data.length                |
+-----+-----+-----+-----+-----+-----+-----+-----+
|                octet []           data.value                  |
+-----+-----+-----+-----+-----+-----+-----+-----+
```

9.6.2.2 Simple Discovery Protocol built-in Endpoints

The Discovery Module within the PIM (Section 8.5) defines the DataTypes *SPDPdiscoveredParticipantData*, *DiscoveredWriterData*, *DiscoveredReaderData*, and *DiscoveredTopicData*. These types define the logical contents of the data sent between the RTPS built-in Endpoints.

The PSM maps these types into the following IDL:

```

struct SPDPdiscoveredParticipantData {
    struct DDS::ParticipantBuiltinTopicData ddsParticipantData;
    struct participantProxy participantProxy;
    Duration_t leaseDuration;
};

struct DiscoveredWriterData {
    struct DDS::PublicationBuiltinTopicData ddsPublicationData;
    struct WriterProxy writerProxy;
};

struct DiscoveredReaderData {
    struct DDS::SubscriptionBuiltinTopicData ddsSubscriptionData;
    struct ReaderProxy readerProxy;
    ContentFilterProperty_t contentFilterProperty;
};

struct DiscoveredTopicData {
    struct DDS::TopicBuiltinTopicData ddsTopicData;
};

```

where each DDS built-in topic data type is defined by the DDS specification.

The discovery data is sent using standard **Data** Submessages. In order to allow for QoS extensibility while preserving interoperability between versions of the protocol, the wire-representation of the *SerializedData* within the **Data** Submessage uses a the format of a **ParameterList** SubmessageElement. That is, the *SerializedData* encapsulates each QoS and other information within a separate parameter identified by a ParameterId. Within each parameter, the parameter value is encapsulated using CDR.

For example, in order to add a vendor-specific Endpoint Discovery Protocol (EDP) in the *SPDPdiscoveredParticipantData*, a vendor could define a vendor-specific parameterId and use it to add a new parameter to the **ParameterList** contained in *SPDPdiscoveredParticipantData*. The presence of this parameterId would denote support for the corresponding EDP. As this is a vendor-specific parameterId, other vendors' implementations would simply ignore the parameter and the information it contains. The parameter itself would contain any additional data required by the vendor-specific EDP encapsulated using CDR.

For optimization, implementations of the protocol may choose not to include a parameter in the Data submessage if it contains information that is redundant with other parameters already present in that same Data submessage. As a result of this optimization an implementation can omit the serialization of the parameters listed in Table 9.10.

Table 9.10 - ParameterId subspaces

<u>BuiltinEndpoint</u>	<u>Parameter which may be omitted</u>	<u>Parameter where the information on the omitted parameter can be found</u>
<u>SPDPdiscoveredParticipantData</u>	<u>ParticipantProxy::guidPrefix</u>	<u>ParticipantBuiltinTopicData::key</u>
<u>DiscoveredReaderData</u>	<u>ReaderProxy::remoteReaderGuid</u>	<u>SubscriptionBuiltinTopicData::key</u>

Table 9.10 - ParameterId subspaces

<u>BuiltinEndpoint</u>	<u>Parameter which may be omitted</u>	<u>Parameter where the information on the omitted parameter can be found</u>
<u>DiscoveredWriterData</u>	<u>ReaderProxy::remoteWriterGuid</u>	<u>PublicationBuiltinTopicData::key</u>

For example, an implementation of the protocol sending DATA message containing the SPDPdiscoveredParticipantData may omit the parameter that contains the guidPrefix. If the guidPrefix is not present in the DATA message, the implementation of the protocol in the receiver side must derive this value from the “key” parameter which is always present in the DATA message.

9.6.2.2.1 ParameterId space

As described in Section 9.4.2.11, the ParameterId space is 16 bits wide. In order to accommodate vendor specific options and future extensions to the protocol, the ParameterId space is partitioned into multiple subspaces. The ParameterId subspaces are listed in Table 9.11.

Table 9.11 - ParameterId subspaces

Bit	Value	Meaning
ParameterId & 8000 (MSB)	0	Reserved ParameterId.
	1	Vendor-specific ParameterId. Will not be recognized by other vendors’ implementations.
ParameterId & 4000	0	If the ParameterId is not recognized, skip and ignore the parameter.
	1	If the ParameterId is not recognized, treat the parameter as an incompatible QoS. In this case, no communication will be established between the two Entities.

The first subspace division enables vendor-specific ParameterIds. Future minor versions of the RTPS protocol can add new parameters up to a maximum ParameterId of 0x7fff. The range 0x8000 to 0xffff is reserved for vendor-specific options and will not be used by any future versions of the protocol.

For backwards compatibility, both subspaces are subdivided again. If a ParameterId is expected, but not present, the protocol will assume the default value. Similarly, if a ParameterId is present but not recognized, the protocol will either skip and ignore the parameter or treat the parameter as an incompatible QoS. The actual behavior depends on the ParameterId value, see Table 9.11.

9.6.2.2.2 ParameterID values

Table 9.12 summarizes the list of ParameterIDs used to encapsulate the data for the built-in Entities. Table 9.13 lists the Entities to which each parameterID applies and its default value.

Table 9.12 - ParameterId Values

Name	ID	Type
PID_PAD	0x0000	N/A
PID_SENTINEL	0x0001	N/A
PID_USER_DATA	0x002c	UserDataQosPolicy
PID_TOPIC_NAME	0x0005	string<256>
PID_TYPE_NAME	0x0007	string<256>
PID_GROUP_DATA	0x002d	GroupDataQosPolicy
PID_TOPIC_DATA	0x002e	TopicDataQosPolicy
PID_DURABILITY	0x001d	DurabilityQosPolicy
PID_DURABILITY_SERVICE	0x001e	DurabilityServiceQosPolicy
PID_DEADLINE	0x0023	DeadlineQosPolicy
PID_LATENCY_BUDGET	0x0027	LatencyBudgetQosPolicy
PID_LIVELINESS	0x001b	LivelinessQosPolicy
PID_RELIABILITY	0x001A	ReliabilityQosPolicy
PID_LIFESPAN	0x002b	LifespanQosPolicy
PID_DESTINATION_ORDER	0x0025	DestinationOrderQosPolicy
PID_HISTORY	0x0040	HistoryQosPolicy
PID_RESOURCE_LIMITS	0x0041	ResourceLimitsQosPolicy
PID_OWNERSHIP	0x001f	OwnershipQosPolicy
PID_OWNERSHIP_STRENGTH	0x0006	OwnershipStrengthQosPolicy
PID_PRESENTATION	0x0021	PresentationQosPolicy
PID_PARTITION	0x0029	PartitionQosPolicy
PID_TIME_BASED_FILTER	0x0004	TimeBasedFilterQosPolicy
PID_TRANSPORT_PRIORITY	0x0049	TransportPriorityQoSPolicy
PID_PROTOCOL_VERSION	0x0015	ProtocolVersion_t
PID_VENDORID	0x0016	VendorId_t
PID_UNICAST_LOCATOR	0x002f	Locator_t
PID_MULTICAST_LOCATOR	0x0030	Locator_t

Table 9.12 - ParameterId Values

Name	ID	Type
PID_MULTICAST_IPADDRESS	0x0011	IPv4Address_t
PID_DEFAULT_UNICAST_LOCATOR	0x0031	Locator_t
PID_DEFAULT_MULTICAST_LOCATOR	0x0048	Locator_t
PID_METATRAFFIC_UNICAST_LOCATOR	0x0032	Locator_t
PID_METATRAFFIC_MULTICAST_LOCATOR	0x0033	Locator_t
PID_DEFAULT_UNICAST_IPADDRESS	0x000c	IPv4Address_t
PID_DEFAULT_UNICAST_PORT	0x000e	Port_t
PID_METATRAFFIC_UNICAST_IPADDRESS	0x0045	IPv4Address_t
PID_METATRAFFIC_UNICAST_PORT	0x000d	Port_t
PID_METATRAFFIC_MULTICAST_IPADDRESS	0x000b	IPv4Address_t
PID_METATRAFFIC_MULTICAST_PORT	0x0046	Port_t
PID_EXPECTS_INLINE_QOS	0x0043	boolean
PID_PARTICIPANT_MANUAL_LIVELINESS_COUNT	0x0034	Count_t
PID_PARTICIPANT_BUILTIN_ENDPOINTS	0x0044	unsigned long
PID_PARTICIPANT_LEASE_DURATION	0x0002	Duration_t
PID_CONTENT_FILTER_PROPERTY	0x0035	ContentFilterProperty_t
PID_PARTICIPANT_GUID	0x0050	GUID_t
PID_PARTICIPANT_ENTITYID	0x0051	EntityId_t
PID_GROUP_GUID	0x0052	GUID_t
PID_GROUP_ENTITYID	0x0053	EntityId_t
PID_BUILTIN_ENDPOINT_SET	0x0058	BuiltinEndpointSet_t
PID_PROPERTY_LIST	0x0059	sequence<Property_t>
PID_TYPE_MAX_SIZE_SERIALIZED	0x0060	long
PID_ENTITY_NAME	0x0062	EntityName_t
PID_KEY_HASH	0x0070	KeyHash_t
PID_STATUS_INFO	0x0071	StatusInfo_t

Table 9.13 - ParameterId mapping and default values

Name	Used For Fields	Default
PID_PAD	-	N/A
PID_SENTINEL	-	N/A
PID_USER_DATA	ParticipantBuiltinTopicData::user_data PublicationBuiltinTopicData::user_data SubscriptionBuiltinTopicData::user_data	See DDS Specification.
PID_TOPIC_NAME	TopicBuiltinTopicData::name PublicationBuiltinTopicData::topic_name SubscriptionBuiltinTopicData::topic_name	N/A
PID_TYPE_NAME	TopicBuiltinTopicData::type_name PublicationBuiltinTopicData::type_name SubscriptionBuiltinTopicData::type_name	N/A
PID_GROUP_DATA	PublicationBuiltinTopicData::group_data SubscriptionBuiltinTopicData::group_data	See DDS Specification.
PID_TOPIC_DATA	PublicationBuiltinTopicData::topic_data SubscriptionBuiltinTopicData::topic_data	See DDS Specification.
PID_DURABILITY	TopicBuiltinTopicData::durability PublicationBuiltinTopicData::durability	See DDS Specification.
PID_DURABILITY_SERVICE	TopicBuiltinTopicData::durability_service PublicationBuiltinTopicData::durability_service	See DDS Specification.
PID_DEADLINE	TopicBuiltinTopicData::deadline PublicationBuiltinTopicData::deadline SubscriptionBuiltinTopicData::deadline	See DDS Specification.
PID_LATENCY_BUDGET	TopicBuiltinTopicData::latency_budget PublicationBuiltinTopicData::latency_budget SubscriptionBuiltinTopicData::latency_budget	See DDS Specification.
PID_LIVELINESS	TopicBuiltinTopicData::liveliness PublicationBuiltinTopicData::liveliness SubscriptionBuiltinTopicData::liveliness	See DDS Specification.
PID_RELIABILITY	TopicBuiltinTopicData::reliability PublicationBuiltinTopicData::reliability SubscriptionBuiltinTopicData::reliability	See DDS Specification.
PID_LIFESPAN	TopicBuiltinTopicData::lifespan PublicationBuiltinTopicData::lifespan SubscriptionBuiltinTopicData::lifespan	See DDS Specification.

Table 9.13 - ParameterId mapping and default values

Name	Used For Fields	Default
PID_DESTINATION_ORDER	TopicBuiltinTopicData::destination_order PublicationBuiltinTopicData::destination_order SubscriptionBuiltinTopicData::destination_order	See DDS Specification.
PID_HISTORY	TopicBuiltinTopicData::history	See DDS Specification.
PID_RESOURCE_LIMITS	TopicBuiltinTopicData::resource_limits	See DDS Specification.
PID_OWNERSHIP	TopicBuiltinTopicData::ownership	See DDS Specification.
PID_OWNERSHIP_STRENGTH	PublicationBuiltinTopicData::ownership_strength	See DDS Specification.
PID_PRESENTATION	PublicationBuiltinTopicData::presentation	See DDS Specification.
PID_PARTITION	PublicationBuiltinTopicData::partition SubscriptionBuiltinTopicData::partition	See DDS Specification.
PID_TIME_BASED_FILTER	SubscriptionBuiltinTopicData::time_based_filter	See DDS Specification.
PID_PROTOCOL_VERSION	ParticipantProxy::protocolVersion	N/A
PID_VENDORID	ParticipantProxy::vendorId	N/A
PID_UNICAST_LOCATOR	ReaderProxy::unicastLocatorList WriterProxy::unicastLocatorList	N/A
PID_MULTICAST_LOCATOR	ReaderProxy::multicastLocatorList WriterProxy::multicastLocatorList	N/A
PID_MULTICAST_IPADDRESS	ReaderProxy::multicastLocatorList.address WriterProxy::multicastLocatorList.address	N/A
PID_DEFAULT_UNICAST_LOCATOR	ParticipantProxy::defaultUnicastLocatorList	N/A
PID_DEFAULT_MULTICAST_LOCATOR	ParticipantProxy::defaultMulticastLocatorList	N/A
PID_METATRAFFIC_UNICAST_LOCATOR	ParticipantProxy::metatrafficUnicastLocatorList	N/A
PID_METATRAFFIC_MULTICAST_LOCATOR	ParticipantProxy::metatrafficMulticastLocatorList	N/A
PID_DEFAULT_UNICAST_IPADDRESS	ParticipantProxy::defaultUnicastLocatorList.address	N/A
PID_DEFAULT_UNICAST_PORT	ParticipantProxy::defaultUnicastLocatorList.port	N/A
PID_METATRAFFIC_UNICAST_IPADDRESS	ParticipantProxy::metatrafficUnicastLocatorList.address	N/A

Table 9.13 - ParameterId mapping and default values

Name	Used For Fields	Default
PID_METATRAFFIC_UNICAST_PORT	ParticipantProxy::metatrafficMulticastLocatorList.port	N/A
PID_METATRAFFIC_MULTICAST_IPADDRESS	ParticipantProxy::metatrafficMulticastLocatorList.address	N/A
PID_METATRAFFIC_MULTICAST_PORT	ParticipantProxy::metatrafficMulticastLocatorList.port	N/A
PID_EXPECTS_INLINE_QOS	ParticipantProxy::expectsInlineQos	FALSE
PID_PARTICIPANT_MANUAL_LIVELINESS_COUNT	ParticipantProxy::manualLivelinessCount	N/A
PID_PARTICIPANT_BUILTIN_ENDPOINTS	ParticipantProxy::availableBuiltinEndpoints	
PID_PARTICIPANT_LEASE_DURATION	SPDPdiscoveredParticipantData::leaseDuration	{100, 0}
PID_PARTICIPANT_GUID	ParticipantBuiltinTopicData::key PublicationBuiltinTopicData::participant_key SubscriptionBuiltinTopicData::participant_key	N/A
PID_PARTICIPANT_ENTITYID	Reserved for future use by the protocol	
PID_GROUP_GUID	Reserved for future use by the protocol	
PID_GROUP_ENTITYID	Reserved for future use by the protocol	

9.6.3 ParameterId Definitions used to Represent In-line QoS

The Messages module within the PIM (Section 8.3) provides the means for the **Data** (Section 8.3.7.2), ~~NoKeyData (Section)~~, and **DataFrag** (Section 8.3.7.3), ~~and NoKeyDataFrag (Section)~~ Submessages to include QoS policies in-line with the Submessage. The QoS policies are encapsulated using a **ParameterList**.

Section 8.7.2.1 defines the complete set of parameters that can appear within the inlineQos SubmessageElement. The corresponding set of parameterIds is listed in Table 9.14.

Table 9.14 - Inline QoS parameters

Name	ID	IDL description of the contents
PID_PAD	See Table 9.12	N/A
PID_SENTINEL		N/A
PID_TOPIC_NAME		string<256>
PID_DURABILITY		DurabilityQosPolicy
PID_PRESENTATION		PresentationQosPolicy
PID_DEADLINE		DeadlineQosPolicy
PID_LATENCY_BUDGET		LatencyBudgetQosPolicy
PID_OWNERSHIP		OwnershipQosPolicy
PID_OWNERSHIP_STRENGTH		OwnershipStrengthQosPolicy
PID_LIVELINESS		LivelinessQosPolicy
PID_PARTITION		PartitionQosPolicy
PID_RELIABILITY		ReliabilityQosPolicy
PID_TRANSPORT_PRIORITY		TransportPriorityQoSPolicy
PID_LIFESPAN		LifespanQosPolicy
PID_DESTINATION_ORDER		DestinationOrderQosPolicy
PID_CONTENT_FILTER_INFO	0x0055	ContentFilterInfo_t
PID_COHERENT_SET	0x0056	SequenceNumber_t
PID_DIRECTED_WRITE	0x0057	sequence<GUID_t>
PID_ORIGINAL_WRITER_INFO	0x0061	OriginalWriterInfo_t
PID_KEY_HASH	0x0070	KeyHash_t
PID_STATUS_INFO	0x0071	StatusInfo_t

The policies that can appear in-line include a subset of the DataWriter QoS policies (ParameterId defined in Section 9.6.2) and some additional QoS (for which a new ParameterId is defined).

The following sections describe these additional QoS in more detail.

9.6.3.1 Content filter info (PID_CONTENT_FILTER_INFO)

Following the CDR encoding, the wire representation of the *ContentFilterInfo_t* (see Table 9.4) in-line QoS is:

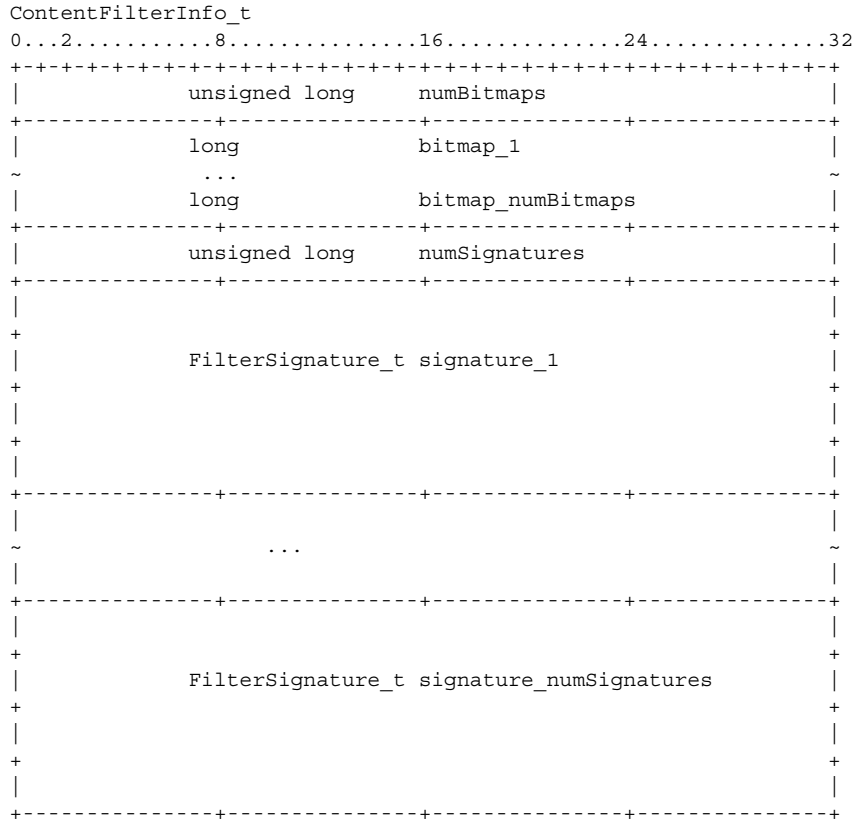

The *filterResult* member is encoded as a bitmap. Bit 0 (MSB) corresponds to the first filter signature, bit 1 to the second filter signature, and so on. The content filter info in-line QoS is invalid unless

```
numBitmaps == ([numSignatures/32] + (numSignatures%32 ? 1 : 0))
```

The bitmap is interpreted as follows:

Table 9.15 - Interpretation of filterResult member in content filter info in-line QoS

bit value	Interpretation
0	Sample was filtered by the corresponding filter and did not pass.
1	Sample was filtered by the corresponding filter and passed.

A filter’s signature is calculated as the 128-bit MD5 checksum of all strings in the filter's *ContentFilterProperty_t*. More precisely, all strings are combined into the following character array:

```
[ contentFilteredTopicName relatedTopicName filterClassName filterExpression expressionParameters[0]
expressionParameters[1] ... expressionParameters[numParams - 1] ]
```

where each individual string includes its NULL termination character. The filter signature is calculated by taking the MD5 checksum of the above character sequence.

9.6.3.2 Coherent set (PID_COHERENT_SET)

The coherent set in-line QoS parameter uses the CDR encoding for SequenceNumber_t.

As defined in Section 8.7.5, all ~~Data~~, ~~NoKeyData~~, ~~DataFrag~~ and ~~NoKeyDataFrag~~ Submessages that belong to the same coherent set must contain the coherent set in-line QoS parameter with value equal to the sequence number of the first sample in the set.

For example, assume a coherent set contains sample updates with sequence numbers 3, 4, 5 and 6 from a given *Writer*. Samples in this coherent set are identified by including the coherent set in-line QoS parameter with value 3. Some example **Data** submessages that the *Writer* can use to denote the end of this coherent set are listed in Table 9.16.

Table 9.16 - Example Data Submessages to denote the end of a coherent set

Data Submessage Elements (subset)	Example 1 (new coherent set)	Example 2 (no coherent set)	Example 3 (no coherent set)
DataFlag	1	0	0
InlineQosFlag	1	1	0
KeyHashSuffix	Identifies Object	Ignored	Ignored
writerSN	7	7	7
InlineQos (PID_COHERENT_SET)	7	SEQUENCENUMBER_UNKNOWN	N/A
SerializedData	Valid data	N/A	N/A

9.6.3.3 KeyHash (PID_KEY_HASH)

The key hash inline parameter contains the CDR encoding of the *KeyHash_t*. The *KeyHash_t* is defined as a 16-Byte octet array (see Table 9.4) therefore the key hash inline parameter just copies those 16 Bytes.

The *KeyHash_t* is computed from the Data as follows using one of two algorithms depending on whether the Data type is such that the maximum size of the sequential CDR encapsulation of all the key fields is guaranteed to be less than 128bits (the size of the *KeyHash_t*):

- If the maximum size of the sequential CDR encapsulation of all the key fields is guaranteed to be less than 128 bits then the *KeyHash_t* shall be computed as the CDR Big-Endian encapsulation of all the Key fields in sequence. Any unfilled bits in the *KeyHash_t* after all the key fields have been encapsulated shall be set to zero.
- Otherwise the *KeyHash_t* shall be computed as a 128 bit MD5 Digest (IETF RFC 1321) applied to the CDR Big-Endian encapsulation of all the Key fields in sequence.

Note that the choice of the algorithm to use depends on the data-type, not on any particular data value.

Example 1: Assume the following IDL-described type:

```

struct TypeWithShortKey {
    long id; /* assume defined as a key field */
    string name<6>; /* assume defined as a key field */
    /* other non-key fields */
};

```

Then we know that the maximum size for the CDR encapsulation of the key fields is 15 Bytes (4 for the 'id' field, plus 4 for the length of the string 'name' plus at most 7 Bytes for the string (includes extra byte for terminating NUL)).

In this example the *KeyHash t* shall be computed as:

```
_____ [CDR(id), CDR(name), <zero fill to 16 bytes> ]
```

Where CDR(x) represents the big-endian CDR encapsulation of that field.

A concrete data value of this type such as { 32, "hello", ... } would be encapsulated as:

```
0.....8.....16.....24.....32
+---+---+---+---+---+---+---+---+---+---+---+---+
| 0x00 | 0x00 | 0x00 | 0x20 |
+-----+-----+-----+-----+
| 0x00 | 0x00 | 0x00 | 0x06 |
+-----+-----+-----+-----+
| 'h'  | 'e'  | 'l'  | 'l'  |
+-----+-----+-----+-----+
| 'o'  | 0x00 | 0x00 | 0x00 |
+-----+-----+-----+-----+
```

Note that for clarity use a notation where each byte can be represented either as an hexadecimal number (e.g. 0x20) or as a character (e.g. 'h');

Example 2: Assume the following IDL-described type:

```
struct TypeWithShortKey {
    long id; _____ /* assume defined as a key field */
    string name<8>; /* assume defined as a key field */
    /* other non-key fields */
};
```

Then we know that the maximum size for the CDR encapsulation of the key fields is 17 Bytes (4 for the 'id' field, plus 4 for the length of the string 'name' plus at most 9 Bytes for the string (includes extra byte for terminating NUL)).

In this example the *KeyHash t* shall be computed as:

```
_____ MD5( [CDR(id), CDR(name)] )
```

9.6.3.4 StatusInfo t (PID STATUS INFO)

The status info parameter contains the CDR encoding of the *StatusInfo t*. The *StatusInfo t* is defined as a 4-Byte octet array (see Table 9.4) therefore the status info inline parameter just copies those 4 Bytes.

The status info parameter may appear in the **Data** or in the **DataFrag** submessages.

The *StatusInfo t* shall be interpreted as a 32-bit worth of flags with the layout shown below:

```
0...2.....8.....16.....24.....32
+---+---+---+---+---+---+---+---+---+---+---+---+
|X|X|X|X|X|X|X|X|X|X|X|X|X|X|X|X|X|X|X|X|X|X|X|X|X|X|X|X|U|D|
+-----+-----+-----+-----+-----+-----+-----+-----+
```

The flags represented with the literal 'X' are unused by this version of the protocol and should be set to zero by the writer and not interpreted by the reader so that they may be used in future versions of the protocol without breaking interoperability.

The flags in the status info provide information on the status of the data-object to which the submessage refers. Specifically the status info is used to communicate changes to the LifecycleState of a data-object instance.

The current version of the protocol defines the *DisposeFlag* and the *UnregisterFlag*.

The *DisposeFlag* is represented with the literal ‘D’.

D=1 indicates that the DDS DataWriter has disposed the instance of the data-object whose Key appears in the submessage.

The *UnregisterFlag* is represented with the literal ‘U’.

U=1 indicates that the DDS DataWriter has unregistered the instance of the data-object whose Key appears in the submessage.

9.6.4 ParameterIds Deprecated by Version 2.1 of the Protocol

Version 2.1 of the protocol deprecates the ParameterIds shown in Table 9.17. These parameters should not be used by future versions of the protocol unless they are used with the same meaning as in versions prior to 2.1. Implementations that wish to interoperate with earlier versions should send and process the parameters in Table 9.17.

Table 9.17 - Deprecated ParameterId Values

Name	ID	History
PID_PERSISTENCE	0x0003	
PID_TYPE_CHECKSUM	0x0008	
PID_TYPE2_NAME	0x0009	
PID_TYPE2_CHECKSUM	0x000a	
PID_EXPECTS_ACK	0x0010	
PID_MANAGER_KEY	0x0012	
PID_SEND_QUEUE_SIZE	0x0013	
PID_RELIABILITY_ENABLED	0x0014	
PID_VARGAPPS_SEQUENCE_NUMBER_LAST	0x0017	
PID_RECV_QUEUE_SIZE	0x0018	
PID_RELIABILITY_OFFERED	0x0019	

10 Data Encapsulation

Data encapsulation is not strictly part of the RTPS protocol. As discussed in Section 8.3.5.12, the RTPS protocol is agnostic to how the data in the **SerializedData** SubmessageElement is encapsulated. Instead, data encapsulation is the responsibility of the DDS type-plugin, which serializes and de-serializes the data.

For the purpose of interoperability, however, it is important that type-plugins from different DDS implementations encapsulate data in the same way. This additional chapter defines a common data encapsulation scheme to be used by all DDS type-plugins.

10.1 Data Encapsulation

A common approach to data encapsulation is OMG CDR. Depending on the specific data type, it may be desirable to use alternative encapsulation methods. For example, the RTPS built-in **Endpoints** use the **ParameterList** encapsulation for exchanging discovery information. The **ParameterList** encapsulation enables easy extension of the data type while maintaining backwards compatibility. This functionality becomes important when adding new QoS values.

In order to support multiple data encapsulation schemes, some additional information is needed that describes the encapsulation scheme. That is, the **SerializedData** must include both a data encapsulation scheme identifier and the actual data itself. The DDS type-plugin parses the data encapsulation scheme identifier before deserializing the rest of the data.

For the purpose of interoperability, DDS implementations must support at least CDR encapsulation for application defined data types. The encapsulation of the data associated with built-in Topics must use a **ParameterList**, as discussed in Section 9.6.2.

10.1.1 Standard Data Encapsulation Schemes

10.1.1.1 Common Approach

All data encapsulation schemes must start with an encapsulation scheme identifier.

```
octet[2] Identifier
```

The identifier occupies the first two octets of the serialized data-stream, as shown below:

```
0...2.....8.....16.....24.....32
+-----+-----+-----+-----+-----+-----+-----+-----+
| Encapsulation Identifier | | | | | | | | | | | | | | | | | | | |
+-----+-----+-----+-----+-----+-----+-----+-----+
-----stream----->>>>
```

The remaining part of the serialized data stream either contains the actual data or additional encapsulation specific information.

The current pre-defined data encapsulation schemes are listed in Table 10.1.

Table 10.1 - Pre-defined data encapsulation schemes

Encapsulation Scheme Identifier	Value	Descriptions
CDR_BE	0x0000	OMG CDR Big Endian See Section 10.1.1.2.
CDR_LE	0x0001	OMG CDR Little Endian See Section 10.1.1.2.
PL_CDR_BE	0x0002	ParameterList (Section 9.4.2.11). Both the parameter list and its parameters are encapsulated using OMG CDR Big Endian. See Section 10.1.1.3.
PL_CDR_LE	0x0003	ParameterList (Section 9.4.2.11). Both the parameter list and its parameters are encapsulated using OMG CDR Little Endian. See Section 10.1.1.3.

Additional data encapsulation schemes, such as for example XML, may be added in future versions of the specification.

10.1.1.2 OMG CDR

In addition to the encapsulation identifier, the OMG CDR encapsulation specifies the length of the data followed by the data encapsulated using CDR. The same encapsulation scheme is used for both the length and serialized data.

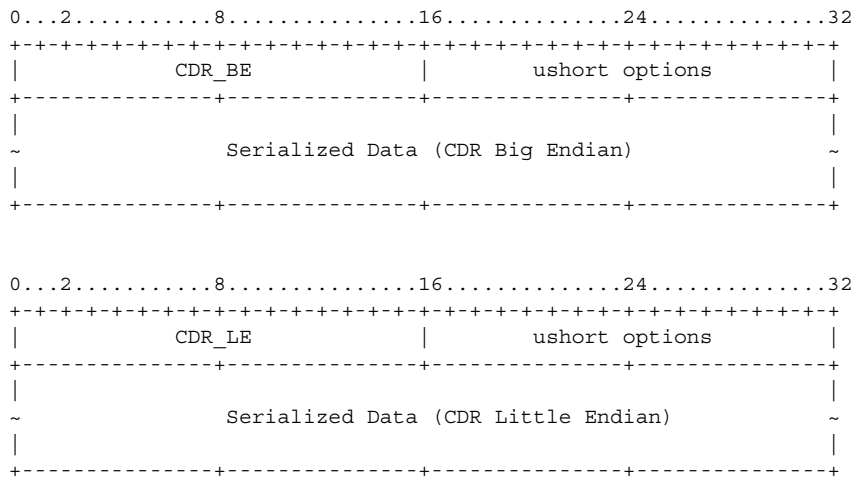

Fragmentation is done after encapsulation of large serialized data, so a SerializedDataFragment may contain the encapsulation header of its opaque and fragmented SerializedData sample.

10.1.1.3 ParameterList

In addition to the encapsulation identifier, the ParameterList encapsulation specifies the length of the data followed by the data encapsulated using a ParameterList. The same CDR encoding is used for both the length and the parameter list.

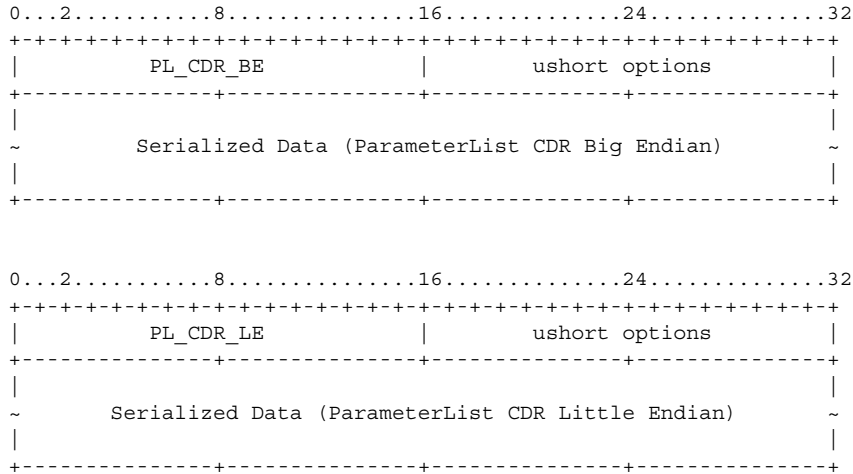

Fragmentation is done after encapsulation of large serialized data, so a SerializedDataFragment may contain the encapsulation header of its opaque and fragmented SerializedData sample.

10.1.2 Example

10.1.2.1 OMG CDR

Consider the following data type expressed in IDL:

```

struct example {
    long a;
    char b[4];
};

```

For the purpose of this example, let's assume the following values:

```

a = 1;
b[0] = 'a', b[1] = 'b', b[2] = 'c', b[3] = 'd';

```

The resulting encapsulation when using CDR in big-endian format is shown below:

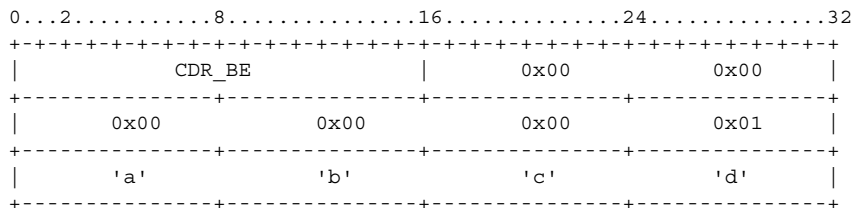

where

```

CDR_BE = 0x0000

```

The same data instance encoded using CDR in little-endian format results in:

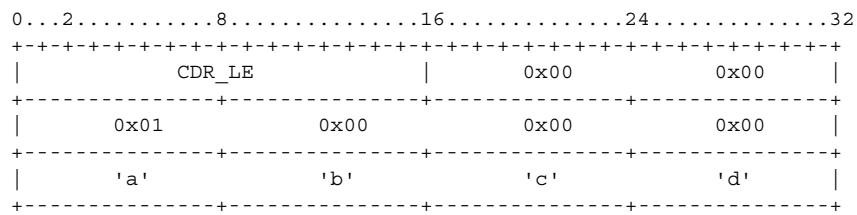

where

CDR_LE = 0x0001

A
Application level interface 5
Application portability 5

C
CDR Wire Representation 151
ChangeForReader 103
Conformance 1
Content-filtered topics 146
ContentFilterInfo_t 148
ContentFilterProperty_t 147

D
Data Distribution Service specification 5
Data encapsulation 195
Data-Centric Publish-Subscribe (DCPS) 5
DataWriter 5
DDS DataReader 11, 27
DDS DataWriter 11, 24
Discovery Module 127
Discovery traffic 182

E
Endpoint Discovery Protocol (EDP) 127

G
Globally Unique Identifier (GUID) 152
GUID 21

H
HistoryCache 16

I
IDL Representation 151
Implementation guidelines 125
Interoperability 71

J
JMS 5

M
Message 160
Messages module 29
Model-Driven Architecture (MDA) 5

N
name-space 151
Notational conventions 75

O
OMG CDR encapsulation 196
OriginalWriterInfo_t 151

P
ParameterList 197
Participant Discovery Protocol (PDP) 127
PIM SubmessageElements 160
Platform Specific Model (PSM) 151
Platform-Specific Models (PSMs) 7
Port number expressions 183
Property lists 150

Q
QoS parameters 144

R
Reader Reference Implementations 105
ReaderLocator operations 82
ReaderProxy operations 85
Real-Time Publish Subscribe (RTPS) protocol 6
References 1

RTPS 6
RTPS CacheChange 19
RTPS Endpoint
 RTPS Entity 23
RTPS Entities and Classes 12
RTPS Entity 20
RTPS HistoryCache 16
RTPS HistoryCache Operations 17
RTPS Message 31
RTPS Message Receiver 35
RTPS Participant
 RTPS Entity 22
RTPS Platform Specific Model (PSM) 10
RTPS Protocol 73
RTPS Reader 23, 106
 RTPS Endpoint 107
RTPS Reader operations 107
RTPS ReaderLocator 82
RTPS ReaderProxy 84, 88, 113
RTPS SPDPdiscoveredParticipantData 130
RTPS StatefulReader
 RTPS Reader 108
RTPS StatefulWriter
 RTPS Writer 83
RTPS StatelessWriter
 RTPS Writer 80
RTPS Submessages 37
RTPS transport model 10
RTPS virtual machine 11
RTPS Writer 23
RTPS Writer operations 79
RTPS Writer Reference Implementations 76
RTPS WriterProxy 110

S
Scope 5, 11, 151, 195
Simple Endpoint Discovery Protocol 134
Simple Endpoint Discovery Protocol (SEDP) 127
Simple Participant Discovery Protocol (SPDP) 127, 128, 183
SPDPbuiltinParticipantReader 133
SPDPbuiltinParticipantWriter 133
Stateful Reference Implementatio 73
StatefulReader Behavior 115
StatefulReader operations 109
StatefulWriter Behavior 95
StatefulWriter operations 83
Stateless Reference Implementation 73
StatelessReader Behavior 113
StatelessReader operations 108
StatelessWriter operations 81
Submessages 44, 168
Symbols 1

T
TCP/UDP/IP 5
Trade-offs 5
Types used to define RTPS messages 30
Types used within the RTPS Entities and Classes 13
Types used within the RTPS Model classes 75

U
UDP/IP 151
Unidirectional data exchange 5
User traffic 183

V
Virtual machine 12

W

Wire protocol 5

Writer Liveliness Protocol 121

WriterProxy operations 110