

An OMG[®] Semantics of Business Vocabulary and Business Rules[™] Publication



OBJECT MANAGEMENT GROUP[®]

Semantics of Business Vocabulary and Business Rules[™]

Version 1.5

OMG Document Number: formal/2019-10-02 [SMSC/19-10-02]
Release Date: October 2019
Standard document URL: <https://www.omg.org/spec/SBVR/1.5/PDF>
Machine Readable Files (normative):

<https://www.omg.org/spec/SBVR/20190601/SBVR-XMI-Metamodel.xml>
<https://www.omg.org/spec/SBVR/20190601/SBVR-XML-Schema.xsd>
<https://www.omg.org/spec/SBVR/20190601/SBVR-Content-Model-for-SBVR.xml>

Copyright © 2005-2007, Business Rule Solutions, LLC
Copyright © 2005-2007, Business Semantics Ltd
Copyright © 2005-2007, Fujitsu Ltd
Copyright © 2005-2007, Hendryx & Associates
Copyright © 2005-2007, LibRT
Copyright © 2005-2007, KnowGravity Inc
Copyright © 2005-2007, Model Systems
Copyright © 2005-2007, Neumont University
Copyright © 1997-2019, Object Management Group
Copyright © 2005-2007, Unisys Corporation

USE OF SPECIFICATION - TERMS, CONDITIONS & NOTICES

The material in this document details an Object Management Group specification in accordance with the terms, conditions and notices set forth below. This document does not represent a commitment to implement any portion of this specification in any company's products. The information contained in this document is subject to change without notice.

LICENSES

The companies listed above have granted to the Object Management Group, Inc. (OMG) a nonexclusive, royalty-free, paid up, worldwide license to copy and distribute this document and to modify this document and distribute copies of the modified version. Each of the copyright holders listed above has agreed that no person shall be deemed to have infringed the copyright in the included material of any such copyright holder by reason of having used the specification set forth herein or having conformed any computer software to the specification.

Subject to all of the terms and conditions below, the owners of the copyright in this specification hereby grant you a fully-paid up, non-exclusive, nontransferable, perpetual, worldwide license (without the right to sublicense), to use this specification to create and distribute software and special purpose specifications that are based upon this specification, and to use, copy, and distribute this specification as provided under the Copyright Act; provided that: (1) both the copyright notice identified above and this permission notice appear on any copies of this specification; (2) the use of the specifications is for informational purposes and will not be copied or posted on any network computer or broadcast in any media and will not be otherwise resold or transferred for commercial purposes; and (3) no modifications are made to this specification. This limited permission automatically terminates without notice if you breach any of these terms or conditions. Upon termination, you will destroy immediately any copies of the specifications in your possession or control.

PATENTS

The attention of adopters is directed to the possibility that compliance with or adoption of OMG specifications may require use of an invention covered by patent rights. OMG shall not be responsible for identifying patents for which a license may be required by any OMG specification, or for conducting legal inquiries into the legal validity or scope of those patents that are brought to its attention. OMG specifications are prospective and advisory only. Prospective users are responsible for protecting themselves against liability for infringement of patents.

GENERAL USE RESTRICTIONS

Any unauthorized use of this specification may violate copyright laws, trademark laws, and communications regulations and statutes. This document contains information which is protected by copyright. All Rights Reserved. No part of this work covered by copyright herein may be reproduced or used in any form or by any means--graphic, electronic, or mechanical, including photocopying, recording, taping, or information storage and retrieval systems--without permission of the copyright owner.

DISCLAIMER OF WARRANTY

WHILE THIS PUBLICATION IS BELIEVED TO BE ACCURATE, IT IS PROVIDED "AS IS" AND MAY CONTAIN ERRORS OR MISPRINTS. THE OBJECT MANAGEMENT GROUP AND THE COMPANIES LISTED ABOVE MAKE NO WARRANTY OF ANY KIND, EXPRESS OR IMPLIED, WITH REGARD TO THIS PUBLICATION, INCLUDING BUT NOT LIMITED TO ANY WARRANTY OF TITLE OR OWNERSHIP, IMPLIED WARRANTY OF MERCHANTABILITY OR WARRANTY OF FITNESS FOR A PARTICULAR PURPOSE OR USE. IN NO EVENT SHALL THE OBJECT MANAGEMENT GROUP OR ANY OF THE COMPANIES LISTED ABOVE BE LIABLE FOR ERRORS CONTAINED HEREIN OR FOR DIRECT, INDIRECT, INCIDENTAL, SPECIAL, CONSEQUENTIAL, RELIANCE OR COVER DAMAGES, INCLUDING LOSS OF PROFITS, REVENUE, DATA OR USE, INCURRED BY ANY USER OR ANY THIRD PARTY IN CONNECTION WITH THE FURNISHING, PERFORMANCE, OR USE OF THIS MATERIAL, EVEN IF ADVISED OF THE POSSIBILITY OF SUCH DAMAGES.

The entire risk as to the quality and performance of software developed using this specification is borne by you. This disclaimer of warranty constitutes an essential part of the license granted to you to use this specification.

RESTRICTED RIGHTS LEGEND

Use, duplication or disclosure by the U.S. Government is subject to the restrictions set forth in subparagraph (c) (1) (ii) of The Rights in Technical Data and Computer Software Clause at DFARS 252.227-7013 or in subparagraph (c)(1) and (2) of the Commercial Computer Software - Restricted Rights clauses at 48 C.F.R. 52.227-19 or as specified in 48 C.F.R. 227-7202-2 of the DoD F.A.R. Supplement and its successors, or as specified in 48 C.F.R. 12.212 of the Federal Acquisition Regulations and its successors, as applicable. The specification copyright owners are as indicated above and may be contacted through the Object Management Group, 109 Highland Avenue, Needham, MA 02494, U.S.A.

TRADEMARKS

CORBA®, CORBA logos®, FIBO®, Financial Industry Business Ontology®, FINANCIAL INSTRUMENT GLOBAL IDENTIFIER®, IIOP®, IMM®, Model Driven Architecture®, MDA®, Object Management Group®, OMG®, OMG Logo®, SoaML®, SOAML®, SysML®, UAF®, Unified Modeling Language®, UML®, UML Cube Logo®, VSIPL®, and XMI® are registered trademarks of the Object Management Group, Inc.

For a complete list of trademarks, see: https://www.omg.org/legal/tm_list.htm. All other products or company names mentioned are used for identification purposes only, and may be trademarks of their respective owners.

COMPLIANCE

The copyright holders listed above acknowledge that the Object Management Group (acting itself or through its designees) is and shall at all times be the sole entity that may authorize developers, suppliers and sellers of computer software to use certification marks, trademarks or other special designations to indicate compliance with these materials. Software developed under the terms of this license may claim compliance or conformance with this specification if and only if the software compliance is of a nature fully matching the applicable compliance points as stated in the specification. Software developed only partially matching the applicable compliance points may claim only that the software was based on this specification, but may not claim compliance or conformance with this specification. In the event that testing suites are implemented or approved by Object Management Group, Inc., software developed using this specification may claim compliance or conformance with the specification only if the software satisfactorily completes the testing suites.

OMG's Issue Reporting Procedure

All OMG specifications are subject to continuous review and improvement. As part of this process we encourage readers to report any ambiguities, inconsistencies, or inaccuracies they may find by completing the Issue Reporting Form listed on the main web page <https://www.omg.org>, under Documents, Report a Bug/Issue.

Table of Contents

Preface	xiii
Part I - Introduction	1
1 Scope	1
1.1 General	1
1.2 Applicability	1
1.3 SBVR Specification Files	2
1.4 Terminological Dictionaries and Rulebooks	2
1.5 Usage of an SBVR Content Model	3
1.6 For SBVR Tool Vendors	3
2 Conformance	4
2.1 General	4
2.2 Types of conformance	4
2.3 Conformance Claim Requirement to Specify SBVR Concepts Supported	5
2.4 Terminological Dictionary and/or Rulebook Interchange Conformance	6
2.4.1 General	6
2.4.2 Conformance of an SBVR Producer	7
2.4.3 Conformance of an SBVR Processor	7
3 Normative References	8
4 Terms and Definitions	8
5 Symbols	9
6 Additional Information	9
6.1 How to Read this Specification	9
6.1.1 About the Annexes	10
6.1.2 About the Normative Specification	11
6.2 Acknowledgements	12
Part II - Terminological Dictionary for Terminological Dictionaries and Rulebooks	15
7 Vocabulary Registration Vocabulary	17
7.1 Vocabulary Registration Vocabulary	17
7.1.1 Vocabularies Presented in this Document	17
7.1.2 External Vocabularies and Namespaces	17
8 Linguistic Foundations	19
8.1 Things, Meanings, and Expressions	19

8.1.1	Semiotic/Semantic Triangle in SBVR Terms	19
8.1.2	SBVR Concepts for the Corners of the Semiotic/Semantic Triangle	20
8.1.3	SBVR Concepts for the Sides of the Semiotic/Semantic Triangle	21
8.2	Kinds of Thing	21
8.3	Kinds of Meaning	24
8.3.1	Kinds of Meaning	24
8.3.2	Kinds of Proposition	26
8.4	Kinds of Expression	28
8.5	Connections between Concepts and Things in the Business	29
8.5.1	Introduction	30
8.5.2	Extensions	29
8.5.3	Instances	30
8.6	Connections between Kinds of Meaning and States of Affairs in the Business	31
8.6.1	Connections between Propositions and States of Affairs in the Business	31
8.6.2	Connections between Propositions and Actualities in the Business	32
8.6.3	Connections between Elements of Guidance and States of Affairs in the Business	33
8.6.4	Connections between Roles and the Things in the Business that Play Them	34
8.7	Connections between Expressions and Things in the Business	35
8.8	Necessities Concerning Extension.....	36
9	Communities and Authorities	39
9.1	Communities and Subcommunities	39
9.1.1	Community	39
9.1.2	Kinds of Community	40
9.2	Authorities	41
10	Characteristics	43
10.1	Introduction	43
10.2	Characteristic	43
10.3	Kinds of Characteristic	44
10.4	Concept Generalization/Specialization	45
11	Concepts	47
11.1	Noun Concepts	47
11.1.1	Introduction	47
11.1.2	Noun Concept	47
11.1.3	General Noun Concepts	47
11.1.4	Individual and Unitary Noun Concepts	49
11.2	Verb Concepts	50
11.2.1	Introduction	50
11.2.2	Verb Concept	50
11.2.3	Verb Concept Role	51
11.2.4	Verb Concepts and Propositions	51
11.2.5	Kinds of Verb Concept	52

11.3	Reference Schemes	53
12	Representations	57
12.1	Representations	57
12.1.1	Representation	57
12.1.2	Representation Formality	58
12.1.3	Representation Disambiguation	59
12.2	Designations	60
12.2.1	Designation	60
12.2.2	Verbal and Nonverbal Designations	61
12.2.3	Designation Preferences	63
12.2.4	Placeholder and Verb Concept Role Designation	64
12.3	Wordings for Verb Concepts	65
12.3.1	Verb Concept Wording.....	65
12.3.2	Kinds of Verb Concept Wording	67
12.4	Placeholders in Verb Concept Wordings	69
12.5	Statements	70
13	Concept Definition	73
13.1	Definitions	73
13.2	Definitional Entries	75
14	Structures in Concept Systems	77
14.1	Structural Connections between Things	77
14.1.1	Associations	77
14.1.2	Partitive Connections	79
14.2	Structural Connection between Concepts	80
14.2.1	Categorization	80
14.2.2	Classification	82
14.2.3	Characterization	83
14.2.4	Verb Concept Objectifications	84
14.3	Contextualization	85
14.3.1	Context of Thing	85
14.3.2	Situations	86
14.3.3	Facets	88
14.4	Elements of Concept System Structure	90
14.5	Conceptualization Choices	91
15	Elementary Concepts	93
15.1	Introduction	93
15.2	Quantities	93
15.3	Numbers	94
15.4	Sets	94
16	Business Rules	97
16.1	Elements of Guidance	97
16.1.1	Introduction	97

16.1.2	Business Rules and Advices	98
16.1.3	Elements of Governance	100
16.2	Element of Guidance Statements	100
16.3	Fundamental Principles for Elements of Guidance	102
16.3.1	The Severability Principle	102
16.3.2	The Accommodation Principle	103
16.3.3	The Wholeness Principle	103
16.4	Accommodations, Exceptions, and Authorizations	103
16.4.1	Authorizations	103
16.4.2	Exceptions	104
16.4.3	Approaches to Capturing Accommodations, Exceptions, and Authorizations ..	104
17	Definitional Guidance	109
17.1	Definitional Elements of Guidance	109
17.1.1	Introduction	109
17.1.2	Definitional Rules	109
17.1.3	Definitional Advices	110
17.2	Definitional Element of Guidance Statements	111
17.2.1	Statements of Definitional Rules	111
17.2.2	Statements of Definitional Advices	113
17.3	Connections between Definitional Rules and Concepts	114
18	Behavioral Guidance	117
18.1	Behavioral Elements of Guidance	117
18.1.1	Introduction	117
18.1.2	Behavioral Rules	117
18.1.3	Business Rule Enforcement	119
18.1.4	Behavioral Advices	119
18.2	Behavioral Element of Guidance Statements	121
18.2.1	Statements of Behavioral Rules	121
18.2.2	Statements of Behavioral Advices	123
19	Business Collections of Meanings and Representations	125
19.1	Bodies of Meanings	125
19.1.1	Bodies of Shared Meaning	125
19.1.2	Bodies of Shared Concepts	126
19.1.3	Bodies of Shared Guidance	127
19.2	Sets of Business Representations	127
19.2.1	Business Vocabularies	127
19.2.2	Speech Community Representation Sets	129
19.3	Ways of Packaging SBVR Content for Publication	131
19.3.1	Terminological Dictionaries	131
19.3.2	Rulebooks	132
19.4	Business Contents of a Communication	133
19.5	Namespaces	134
19.5.1	Namespace	134

19.5.2	Vocabulary Namespaces	135
19.5.3	Attributive Namespaces	136
20	Adoption	137
20.1	Adoption of Definitions	137
20.2	Adoption of Business Rules	138
21	Logical Formulation of Semantics	141
21.1	General	141
21.2	Semantic Formulations	144
21.3	Logical Formulations	145
21.3.1	Variables and Bindings	146
21.3.2	Atomic Formulations	150
21.3.3	Instantiation Formulations	151
21.3.4	Modal Formulations	152
21.3.5	Logical Operations	155
21.3.6	Quantifications	158
21.3.7	Objectifications	164
21.3.8	Projecting Formulations	166
21.3.9	Nominalizations of Propositions and Questions	170
21.4	Projections	174
22	Index of Vocabulary Entries (Informative)	183
Part III - Transformation to XMI Metamodel and Metamodel's		
	Interpretation in Formal Logics	193
23	SBVR's Use of MOF and XMI	195
23.1	General	195
23.2	SBVR's Use of MOF	195
23.2.1	SBVR uses MOF as a syntax to represent SBVR semantics	195
23.2.2	SBVR Content Models	196
23.2.3	ransformation that creates SBVR Vocabulary Namespaces.....	197
23.3	MOF Model Elements for SBVR	198
23.3.1	MOF Packages for SBVR Vocabulary Namespaces	199
23.3.2	MOF Classes for SBVR Noun Concepts	199
23.3.3	MOF Boolean Attributes for SBVR Characteristics	201
23.3.4	MOF Associations for SBVR Binary Verb Concepts	201
23.3.5	MOF Attributes for SBVR Roles of Verb Concepts	203
23.3.6	MOF Classes for SBVR Ternary Verb Concepts	204
23.3.7	Data Values	204
23.3.8	XMI Names	205
23.4	Using MOF to Represent Semantics	205
23.4.1	Multiclassification	205
23.4.2	Open World Assumption	206
23.5	Example SBVR Content Model	206
23.6	The SBVR Content Model for SBVR	209

23.7 XMI for the SBVR Model of SBVR	210
23.7.1 XML Patterns for Vocabularies	210
23.7.2 XML Patterns for General Concepts	212
23.7.3 XML Patterns for Individual Noun Concepts	214
23.7.4 XML Patterns for Verb Concepts	214
23.7.5 XML Patterns for Sets of Elements of Guidance (Rule Sets)	216
23.7.6 XML Patterns for Guidance Statements	217
24 Providing Semantic and Logical Foundations for Business	
Vocabulary and Rules	219
24.1 General	219
24.2 Logical Foundations for SBVR	219
24.2.1 SBVR Formal Grounding Model Interpretation	219
24.2.2 Formal Logic & Mathematics in General	245
24.3 Formal Logic Interpretation Placed on SBVR Terms	255
25 Supporting Documents	267
25.1 General	267
25.2 SBVR XMI Metamodel	267
25.3 SBVR XMI XML Schema	267
25.4 SBVR Content Model for SBVR	267
Part IV - Annexes.....	269
Annex A - SBVR Structured English	271
Annex B - SBVR Structured English Patterns	291
Annex C - Conventions for Representing an SBVR-Style Vocabulary as a Concept Model Diagram	303
Annex D - Additional References	319
Stand-alone Annexes	
Annex E - Overview of the Approach <i>see https://www.omg.org/cgi-bin/doc?dtd/19-05-23</i>	
Annex F - The Business Rules Approach <i>see https://www.omg.org/cgi-bin/doc?dtd/19-05-24</i>	
Annex G - EU-Rent Example <i>see https://www.omg.org/cgi-bin/doc?dtd/19-06-21</i>	
Annex H - The RuleSpeak[®] Business Rule Notation <i>see https://www.omg.org/cgi-bin/doc?dtd/19-05-26</i>	
Annex I - Concept Diagram Graphic Notation <i>see https://www.omg.org/cgi-bin/doc?dtd/19-05-27</i>	

Annex J - The ORM Notation for Verbalizing Facts and Business Rules

see <https://www.omg.org/cgi-bin/doc?dtc/19-05-28>

Annex K - Mappings and Relationships to Other Initiatives

see <https://www.omg.org/cgi-bin/doc?dtc/19-05-30>

Annex L - ORM Examples Related to the Logical Foundations for SBVR

see <https://www.omg.org/cgi-bin/doc?dtc/19-05-29>

Annex M - A Conceptual Overview of SBVR and the NIAM2007 Procedure to Specify a Conceptual Schema

see <https://www.omg.org/cgi-bin/doc?dtc/19-05-31>

Preface

About the Object Management Group

OMG

Founded in 1989, the Object Management Group, Inc. (OMG) is an open membership, not-for-profit computer industry standards consortium that produces and maintains computer industry specifications for interoperable, portable and reusable enterprise applications in distributed, heterogeneous environments. Membership includes Information Technology vendors, end users, government agencies and academia.

OMG member companies write, adopt, and maintain its specifications following a mature, open process. OMG's specifications implement the Model Driven Architecture® (MDA®), maximizing ROI through a full-lifecycle approach to enterprise integration that covers multiple operating systems, programming languages, middleware and networking infrastructures, and software development environments. OMG's specifications include: UML® (Unified Modeling Language™); CORBA® (Common Object Request Broker Architecture); CWM™ (Common Warehouse Metamodel); and industry-specific standards for dozens of vertical markets.

More information on the OMG is available at <https://www.omg.org/>.

OMG Specifications

As noted, OMG specifications address middleware, modeling, and vertical domain frameworks. A listing of all OMG Specifications is available from the OMG website at:

<https://www.omg.org/spec>

All of OMG's formal specifications may be downloaded without charge from our website. (Products implementing OMG specifications are available from individual suppliers.) Copies of specifications, available in PostScript and PDF format, may be obtained from the Specifications Catalog cited above or by contacting the Object Management Group, Inc. at:

OMG Headquarters
109 Highland Avenue
Needham, MA 02494
USA
Tel: +1-781-444-0404
Fax: +1-781-444-0320
Email: pubs@omg.org

Certain OMG specifications are also available as ISO standards. Please consult <https://www.iso.org>.

Issues

The reader is encouraged to report any technical or editing issues/problems with this specification to <https://issues.omg.org/issues/create-new-issue>

Part I - Introduction

This part includes Scope, Conformance, Normative References, Terms and Definitions, Symbols, and Additional Information.

Note: Issue SBVR15-08 lists the following change: In clauses 8-21, change the annotation line following every figure caption disclaimer to: This diagram shows the SBVR terminological entries of this sub clause as explained in Annex C. This is a global change and is shown with a change bar notation.

1 Scope

1.1 General

This specification defines the vocabulary and rules (see Clauses 7 through 21) for documenting the semantics of business vocabularies and business rules for the exchange of business vocabularies and business rules among organizations and between software tools.

This specification is interpretable in predicate logic with a small extension using modal operators. It supports linguistic analysis of text for business vocabularies and business rules, with the linguistic analysis itself being outside the scope of this specification.

1.2 Applicability

The SBVR specification is applicable to the domain of business vocabularies and business rules of all kinds of business activities in all kinds of organizations. It provides an unambiguous, meaning-centric, multilingual, and semantically rich capability for defining meanings of the language used by people in an industry, profession, discipline, field of study, or organization.

This specification is conceptualized optimally for business people rather than automated processing. It is designed to be used for business purposes, independent of information systems designs to serve these business purposes:

- Unambiguous definition of the meaning of business concepts and business rules, consistently across all the terms, names and other representations used to express them, and across the natural languages in which those representations are expressed, so that they are not easily misunderstood either by “ordinary business people” or by lawyers.
- Expression of the meanings of concepts and business rules in the wordings used by business people, who may belong to different communities, so that each expression wording is uniquely associated with one meaning in a given context.
- Transformation of the meanings of concepts and business rules as expressed by humans into forms that are suitable to be processed by tools, and vice versa.
- Interpretation of the meanings of concepts and business rules in order to discover inconsistencies and gaps within an SBVR Content Model (see 2.4) using logic-based techniques.
- Application of the meanings of concepts and business rules to real-world business situations in order to enable reproducible decisions and to identify conformant and non-conformant business behavior.
- Exchange of the meanings of concepts and business rules between humans and tools as well as between tools without losing information about the essence of those meanings.

1.3 SBVR Specification Files

This specification provides that SBVR Terminological dictionary and Rulebook content is exchanged among organizations and between software tools in “SBVR Content Model” files (see 23.2.2). The full [SBVR Vocabulary](#) (see Clauses 7 through 21) for documenting the semantics of business vocabularies and business rules is contained in the “SBVR Content Model for SBVR” file (see 23.2.1), which is an example of an SBVR Content Model exchange document.

The MOF/XMI XML Schema for SBVR Content Model exchange documents (e.g., 25.4) is the “SBVR XMI XML Schema” file (see Clause 23 Intro and 25.3). This SBVR XMI XML Schema is serialized from the SBVR MOF Metamodel file based on transform rules in Clause 23 and the OMG XMI Specification.

This specification also provides an “SBVR XMI Metamodel” file (see sub clauses 23.1 and 25.2) that is a serialization of the SBVR MOF Metamodel generated from the [SBVR Vocabulary](#) content of Clauses 7 through 21 based on transform rules in Clause 23 and Annex A.

1.4 Terminological Dictionaries and Rulebooks

The capability has two major areas of support:

- SBVR Terminological Dictionary: the business vocabulary part of an SBVR Content Model. As with all kinds of dictionaries, it contains business data content that defines terms and other representations, including definitional business rules.

Dictionaries in general are not metamodels. Dictionaries have no metamodel levels. All terms in a dictionary - including the terms that define the dictionary content itself - are at the same level. Dictionaries are easily and naturally extendable, as happens all the time in the culture. This is also true for SBVR Content Models.

- SBVR Rulebook: an SBVR Content Model that includes behavioral guidance. It comprises an SBVR Terminological Dictionary and business data content that defines elements of guidance, including behavioral business rules.

An SBVR Content Model documents the meaning of terms and other representations that business authors intend when they use them in their business communications, as evidenced in their written documentation, such as contracts, product/service specifications, and governance and regulatory compliance documents. Such documents are the authoritative source for the content of an SBVR Content Model.

In keeping with SBVR’s purpose to define unambiguously the meaning of natural language terms and sentences in any natural language, SBVR Terminological Dictionaries and Rulebooks need to be able to use the entire character set of the language in which their text is written. To this end, SBVR is designed to make it as natural as possible for the business user to author and edit SBVR-clarified content. Unicode encodings contain all of the characters used in all of the natural languages, including readability characters such as smart quotes. Unicode encodings are supported by all of the major word processing editors, many of which, including Microsoft Word and WordPress, insert readability characters such as smart quotes as a default. Since Unicode UTF-8 is the encoding recommended by W3C for Internet documents, SBVR Terminological Dictionaries and Rulebook content can use the full character set in UTF-8. SBVR Content Model exchange documents (Clause 2) containing SBVR Terminological Dictionaries and Rulebook content use UTF-8 encoding normatively, as specified in the SBVR XMI Metamodel XML Schema (Clause 25.4).

1.5 Usage of an SBVR Content Model

Concepts in an SBVR Content Model can have as members in their extension only things that are in the real or planned world of the organization. The extension of each of these concepts never contains anything in the SBVR Content Model. The terms and other representations in an SBVR Content Model name and describe the concepts.

SBVR Content Models focus exclusively on defining meaning and the expressions that represent meaning. They do not concern themselves with or contain assertions of the truth-value of propositions. Such concerns and assertions are outside the scope of SBVR and belong to the domain of data and rules enforcement. While putting business vocabulary in a published SBVR Business Vocabulary and business rules in a published SBVR Rulebook is often used by organizations to communicate that, in fact, this vocabulary is the vocabulary in use and these rules are the rules in force, such assertions are outside the scope of the SBVR specification and SBVR Content Models. For example, an organization could propose rules in a rulebook that are never put into force. SBVR Content Models therefore do not contain any kind of business data except business vocabulary and business rules content.

While this specification contains the SBVR XMI XML Schema (see 25.3) for interchanging the documentation of business vocabulary and business rules content, the SBVR MOF Model, the SBVR XMI Metamodel, and the SBVR XMI XML Schema are not metamodels for any form of data model, message model, business information, or model designed for reasoning over business information. A transformation is required to bridge from an SBVR Content Model to a data model, message model, business information, model for reasoning over business information, or any other IT system model.

An SBVR Content Model provides all the business semantics needed as input to such transformations by IT staff into information system designs, using a combination of decisions from system architects and Platform Independent Model designers together with software tool function. By use of URIs, SBVR Content Models can provide the business intent of any data element for which business vocabulary has been defined.

In SBVR Content Models the key relationship is between meanings in the business vocabulary / rulebook and things in the world of the business; whereas in IT systems the key relationship is between classes in the data/reasoning model and recorded business data in some form.

1.6 For SBVR Tool Vendors

The SBVR XMI Metamodel file is provided as part of this specification (see 25.2).

The SBVR XML Schema file is also provided as part of this specification (see 25.3).

SBVR tools generate and process SBVR Content Model exchange documents that validate according to the “SBVR XMI XML Schema” files of sub clause 25.3. The “SBVR Content Model for SBVR” file of sub clause 25.4 can be used as an example SBVR Content Model exchange document.

The “SBVR XMI Metamodel” file of sub clause 25.2 is a machine-readable metamodel that may be employed in the development of SBVR tools.

2 Conformance

2.1 General

This specification defines conformance for software that implements the specification and for an SBVR Content Model exchange document. Conformance of software is defined in terms of:

- the nature of its use of SBVR (*see sub clauses 2.2 and 2.4*), and
- its support for SBVR concepts that are defined in clauses of this specification and implemented in the SBVR MOF Metamodel as specified in Clause 23 (*see sub clause 2.3*).

2.2 Types of conformance

There are three distinct types of conformance for this SBVR Specification. These are listed below. Unless otherwise stated, these types of conformance are independent.

1. *Abstract syntax conformance.* A tool demonstrating SBVR Abstract syntax conformance provides a user interface, reports and/or an API that enables instances of SBVR concepts that are implemented in the SBVR XMI Metamodel to be created, read, updated, and deleted. User interfaces and reports shall use the representations for these SBVR concepts as specified in Clauses 8 through 21, and APIs shall use the representations for SBVR concepts as specified in Clauses 23 & 25. The tool must also provide a way to validate the well-formedness of the content in SBVR Terminological Dictionaries and Rulebooks based on Definitions and Definitional Rules specified in the [SBVR Vocabulary](#) (Clauses 8 through 21).
2. *Terminological Dictionary and/or Rulebook interchange conformance.* A tool demonstrating SBVR Terminological Dictionary and/or Rulebook interchange conformance can import and export conformant SBVR Content Model Exchange Documents in the SBVR XMI XML Schema files for all valid SBVR Terminological Dictionaries and Rulebooks (*see 2.4 for details*). Terminological Dictionary and/or Rulebook interchange conformance implies SBVR Abstract syntax conformance. A conforming SBVR tool shall be able to load and save SBVR Content Models in the SBVR XMI XML Schema format (*see 25.3*).
3. *SBVR Semantics conformance.* A tool demonstrating SBVR Semantics conformance provides a demonstrable way to interpret SBVR semantics, e.g., reasoning over SBVR Terminological Dictionary and/or Rulebook content to validate it, transformation of SBVR Terminological Dictionaries to UML Domain Logical Data Models or ODM/OWL Domain Reasoning Models, or transformation of SBVR Rulebooks to executable rules. The normative specification for SBVR semantics includes Clauses 8 through 21, 23, & 24. SBVR Semantics conformance implies SBVR Abstract syntax conformance.

2.3 Conformance Claim Requirement to Specify SBVR Concepts Supported

For all types of conformance support for every SBVR concept that is implemented in the SBVR XMI Metamodel is optional. All claims of conformance must specify which SBVR concepts are supported for each of the three types of conformance. With every claim of conformance, a table must be provided with this information in this format:

SBVR Concept implemented in the SBVR XMI Metamodel	Type of Conformance		
	Abstract syntax	Terminological Dictionary and/or Rulebook interchange	Semantics
<i>(show SBVR term, name, or verb concept wording for concept supported)</i>	<i>show "Unser Interface" and/or "Reports", or "Not Supported"</i>	<i>show "Producer" and/or "Processor", or "Not Supported"</i>	<i>name the supported demonstrable way(s) to interprets SBVR semantics</i>

A software tool supports an SBVR concept if and only if all of the following hold:

- The software tool uses the representations specified in SBVR for that concept as specified under *SBVR Abstract syntax conformance*. It may use other representations of the same concept for other purposes, including other forms of exchange documents.
- The software tool interprets the specified representation of the concept as having the meaning given by the Definition of that concept in this specification, and interprets instances of the concept in Terminological Dictionary and Rulebook content as having the associated characteristics.
- No Necessity concerning that concept that is given in this specification is violated by any Terminological Dictionary or Rulebook content maintained by the software tool nor in any SBVR Content Model exchange document the software tool produces.

Note: The requirement to interpret an instance as having the associated characteristics should not be taken to mean that a conforming processor to use any elaborate reasoning to determine characteristics that may be implied by the facts provided, even when those implications are stated as Necessities in SBVR. The intent of the requirement is that what the tool does with the instance is consistent with the SBVR interpretation of the facts provided.

Use of Reference Schemes given in this specification is recommended, but not required.

The Note, Example, and Dictionary Basis subentries of the [SBVR Vocabulary](#) entries in this specification are purely informative. All other elements are to be understood as giving the meaning and required characteristics of the concept. The vocabulary entry also specifies the representation of the concept that is used in this specification, while Clauses 23 and 15 specify the representation of the concept in exchange documents conforming to this specification.

Note: A concept is a meaning. Support for an SBVR concept is about using that meaning appropriately in the operation of the tool, and representing that meaning using the corresponding SBVR representations in all types of conformance that are claimed, as specified under SBVR Abstract syntax conformance. The internal designations and other representations for the meaning, and the representation of that meaning in other exchange documents are not concerns of this specification.

2.4 Terminological Dictionary and/or Rulebook Interchange Conformance

2.4.1 General

This sub clause defines conformance for an SBVR Content Model exchange document, for software that produces SBVR Content Model exchange documents, and for software that processes SBVR Content Model exchange documents.

An exchange document that conforms to this specification (an “SBVR Content Model exchange document”) shall be an XML document that uses the SBVR XMI XML Schema as its XSD (see 25.3). The exchange document shall identify its document type as the XML Schemas specified in sub clause 25.3 by using the URI for that schema specified in sub clause 25.4.

XML text (between XML Element tags; between double quotes in XML attributes) in SBVR Content Model exchange documents is normatively Unicode UTF-8 as per the SBVR XMI Metamodel XML Schema (Clause 25.4). The entire UTF-8 character set is supported. As required by the XML standard, all XML text must use XML Entity References in place of each these five characters < > & ' " that occur within it.

The content of the SBVR Content Model exchange document shall not contradict any Necessity in the [SBVR Vocabulary](#) (Clauses 8 through 21). However, no concept is closed in the SBVR XML Schema (see 25.3). A conforming SBVR Content Model exchange document need not include all of the content in a Terminological Dictionary or Rulebook. No Necessity should be interpreted as a requirement for inclusion of any given fact in the SBVR Content Model exchange document.

EXAMPLE

There is a rule that every statement expresses exactly one proposition. An SBVR Content Model exchange document that includes that a given statement expresses two different propositions is not conformant. But a conforming document can include a statement without relating the statement to a proposition, even though the proposition necessarily exists.

Note: If a use of SBVR for exchange between tools requires that certain kinds of facts be fully represented in the exchange document, the SBVR XML Schema can be extended for that purpose by adding the facts that particular concepts are closed or particular verb concepts are internally closed (see Clause 23).

An exchange document that conforms to this specification may include representations of instances of any SBVR concept that is included in the SBVR XMI Metamodel as specified in Clause 23.

Note: Not every conforming processor will support all of the concepts that can appear in a conforming SBVR document. Every conforming processor, however, is required to accept every conforming document (see sub clause 2.4.3).

For an XML exchange document that involves multiple namespaces, conformance to this specification is only defined for that part of the exchange document that uses the SBVR namespaces defined in this specification.

Note: The document type of a conforming XML exchange document need not be SBVR XML schema defined in sub clause 25.3; but the document’s XML Schema shall include the SBVR XML Schema as a subordinate namespace. Similarly, the SBVR XML Schema permits items like ‘definitions’ to have formal representations defined by other XML Schemas.

2.4.2 Conformance of an SBVR Producer

A software tool that conforms as an SBVR producer shall produce exchange documents that conform to this specification as specified in .

An SBVR producer may be able to produce representations of instances of any concepts specified in Clause 21. An SBVR producer is not required to be able to produce a representation of instances of any specific concept defined in this specification.

For a conforming SBVR producer, a claim of conformance shall identify the SBVR concepts for which it can produce representations of instances (see 2.3).

As indicated in 2.4.1, an SBVR producer may produce instances of concepts not defined in SBVR as well. In such a case, the SBVR Terminological Dictionary and Rulebook content for SBVR concepts in the SBVR XMI XML Schema would be only a part of the SBVR Content Model exchange document.

An SBVR producer shall support (as defined in 2.3) all of the SBVR concepts for which it makes a claim of conformance.

An SBVR producer shall not convey in the exchange document the intent of an SBVR concept by using a representation that is not specified herein.

2.4.3 Conformance of an SBVR Processor

A software tool that conforms as an SBVR processor shall accept any exchange document that conforms to this specification as specified in 2.4.2. The interpretation it makes of any fact contained in the exchange document depends on whether the software tool supports the concepts associated with that fact (see below).

Note: Accepting a valid exchange document is distinguished from rejecting the document as not processable and using none of the information in it. A tool can accept a document and nonetheless discard much of the information in it. Accepting is also distinguished from supporting instances of concepts found in the exchange document, which refers to interpreting all facts about instances of the concept properly into the internal models and functions of the tool (see 2.3).

Every SBVR processor shall be able to accept representations of facts about instances of all SBVR concepts for which a conformance claim of support is made. Every SBVR processor shall be able to accept the SBVR Content Model exchange documents listed in sub clause 25.4.

Note: Depending on what the SBVR processor actually does with the SBVR Content Model exchange document, there may be SBVR concepts for which there is no valid use in the function of the tool (see 2.3). For example, a tool that converts an SBVR Content Model exchange document to some other modeling language or rules language may find that there are SBVR concepts that have no image in the target language. In such a case, the proper support for the SBVR concept may be to do nothing with it.

When an SBVR processor encounters a representation of an instance of a concept for which conformance is not claimed (including concepts that are not SBVR concepts), the processor may choose to do any of the following:

- ignore the instance;
- support the instance, and the SBVR concept it instantiates;
- interpret the instance via internal concepts that are not SBVR concepts per se.

An SBVR processor may, but need not, provide a warning when it encounters a representation of an instance it does not support.

3 Normative References

The following normative documents contain provisions which, through reference in this text, constitute provisions of this specification. For dated references, subsequent amendments to, or revisions of, any of these publications do not apply.

- Berners-Lee, T., R. Fielding, L. Masinter. IETF RFC 2396: *Uniform Resource Identifiers (URI): Generic Syntax*, August 1998.
- International Organization for Standardization (ISO) : ISO 639-2. *Codes for the Representation of Names of Languages, Part 2: Alpha-3 Code*. Library of Congress, 2002.
- International Organization for Standardization (ISO) : 1087-1. *Terminology work — Vocabulary — Part 1: Theory and Application*
- *Meta Object Facility (MOF) Core Specification, v2.4.2*
(<https://www.omg.org/spec/MOF/2.4.2/PDF>)
- *MOF 2.4.2/XMI Mapping Specification, v2.4.2*
(<https://www.omg.org/spec/XMI/2.4.2/PDF>).
- International Organization for Standardization (ISO) : ISO 6093. *Information processing - Representation of numerical values in character strings for information interchange*. 1985.
- *OMG UML 2 Infrastructure, v2.4.1*
(<https://www.omg.org/spec/UML/2.4.1/Infrastructure/PDF>).
- *The Cambridge Dictionary of Philosophy*, 2nd ed. Cambridge University Press, 1999.
- *The New Oxford Dictionary of English*.
- *The Oxford Dictionary of English*.
- *Unicode 4.0.0 specification* : Glossary (<http://www.unicode.org/versions/Unicode4.0.0/b1.pdf>).

4 Terms and Definitions

For the purposes of this specification, the terms and definitions given in the normative reference and the following apply.

SBVR

shorthand for Semantics of Business Vocabulary and Business Rules

Business Vocabulary

vocabulary that is under business jurisdiction

Business Rule

rule that is under business jurisdiction

Business Vocabulary+Rules

business vocabulary plus a set of business rules specified in terms of that business vocabulary

SBVR Content Model

XML document that uses the SBVR XMI XML Schema (see 25.4) and contains SBVR Terminological dictionary and Rulebook content

SBVR Content Model for SBVR

SBVR Content Model that contains the [SBVR Vocabulary](#) in Clauses 7-21 (see 25.4)

SBVR MOF Metamodel

MOF model that is generated, as the metamodel for SBVR Terminological Dictionary and Rulebook content, from some of the terminological entries in SBVR Clauses 7 through 21 by the transformation specified in Clause 23

SBVR XMI Metamodel

Serialization of the SBVR MOF Metamodel (see 25.2)

SBVR XMI XML Schema

XMI XSD for SBVR that is a serialization of the SBVR MOF Metamodel according to the rules in the XMI specification (see 25.3)

Terminological Dictionary

collection of representations including at least one designation or definition of each of a set of concepts from one or more specific subject fields, together with other specifications of those concepts

Vocabulary

set of designations (such as terms and names) and verb concept wordings primarily drawn from a single language to express concepts within a body of shared meanings

note that this specification does not use the word “vocabulary” to refer to a dictionary or to any other sort of collection of terminological data

5 Symbols

FL The indicated term is to be interpreted in formal logic. Terms without this symbol are not interpreted in formal logic.

For the purpose of visualizing entries in the [SBVR Vocabulary](#), Annex C describes a non-normative interpretation of the figures in Clauses 7-21 and of figures in Annex G. Other non-normative notations used in Clauses 7 through 21 are explained in Annex A.

6 Additional Information

6.1 How to Read this Specification

This specification describes a vocabulary, or actually a set of vocabularies, using terminological entries. Each entry includes a definition, along with other specifications such as notes and examples. Often, the entries include rules (necessities) about the particular item being defined.

The sequencing of the clauses in this specification reflects the inherent logical order of the subject matter itself. Later clauses build semantically on the earlier ones. The initial clauses are therefore rather 'deep' in terms of SBVR's grounding in formal logics and linguistics. Only after these clauses are presented do clauses more relevant to day-to-day business communication and business rules emerge.

This overall form of presentation, essential for a vocabulary standard, unfortunately means the material is rather difficult to approach. A figure presented for each sub-vocabulary does help illustrate its structure; however, no continuous 'narrative' or explanation is appropriate.

6.1.1 About the Annexes

For that reason, the first-time general reader is urged to start with some of the non-normative Annexes, which do provide full explanation of the material, as well as context and purpose.

- Annex E, Overview of the Approach, is strongly recommended in that regard. It provides a general introduction to the fundamental concepts and approach of SBVR.
- Annex F, The Business Rules Approach, explains the core ideas and principles of business rules, which underpin SBVR's origin and focus. This short Annex is strongly recommended for readers who are unfamiliar with this area.

Good preparation for reading the specification is becoming familiar with the notation (non-normative) used to present the entries.

- Annex A, SBVR Structured English, provides comprehensive explanation in that regard.
- Annex B, SBVR Structured English Patterns, explains how to verbalize terminological entries.
- Annex C, Use of a business-friendly notation to visualize the connections between [SBVR Vocabulary](#) entries.

General practitioners will find the following sections of significant interest.

- Annex G, EU-Rent Example, provides a comprehensive case study, with a robust vocabulary and set of business rules fully worked through. Examples from EU-Rent are used widely in both the specification and Annexes to provide on-going commonality.
- Annex H, The RuleSpeak^R Business Rule Notation, presents a widely-used, business-friendly syntax for expressing business rules.
- Annex I is superseded by Annex C.

Object-Role Modeling (ORM)-related Annexes:

- Annex J, The ORM Notation for Verbalizing Facts and Business Rules, provides an introduction to the ORM approach. ORM contributes heavily to the theoretical underpinnings of SBVR, and represents some of the best practices in fact-based vocabulary and rule development.
- Annex L, ORM Examples Related to the Logical Foundations for SBVR, provides supplemental ORM material further clarifying the normative material, Logical Foundations for SBVR.

For those specialists and researchers interested in standards and/or in the formal logics underpinning of SBVR, the following material is of special interest.

- Annex K, Mappings and Relationships to Other Initiatives, addresses where and how SBVR fits with other software and standards initiatives.

For practitioners interested in a methodology supporting SBVR, used productively in industry for over 30 years, the fact-oriented approach NIAM2007 offers interesting advice.

- Annex M - a Conceptual Overview of SBVR and the NIAM2007 Procedure to Specify a Conceptual Schema.
- Annex D, Additional References, provides supplemental sources relevant to the formal underpinnings of SBVR.

NOTE: The SBVR Annexes in the table below are now published as stand-alone documents at the URIs shown solely for convenience and ease of use. The fact that they are published as separate SBVR specification documents makes no change to their status as part of the SBVR specification, or the way in which they can be updated under OMG Policies and Procedures.

Annex	Document number	URI
E - Overview of the Approach	formal/19-10-04*	https://www.omg.org/cgi-bin/doc?formal/19-10-04
F - The Business Rules Approach	formal/19-10-05	https://www.omg.org/cgi-bin/doc?formal/19-10-05
G - EU-Rent Example	formal/19-10-06*	https://www.omg.org/cgi-bin/doc?formal/19-10-06
H - The RuleSpeak® Business Rule Notation	formal/19-10-07	https://www.omg.org/cgi-bin/doc?formal/19-10-07
I - Concept Diagram Graphic Notation	formal/19-10-08	https://www.omg.org/cgi-bin/doc?formal/19-10-08
J - The ORM Notation for Verbalizing Facts and Business Rules	formal/19-10-09	https://www.omg.org/cgi-bin/doc?formal/19-10-09
K - Mappings and Relationships to Other Initiatives	formal/19-10-10	https://www.omg.org/cgi-bin/doc?formal/19-10-10
L - ORM Examples Related to the Logical Foundations for SBVR	formal/19-10-11	https://www.omg.org/cgi-bin/doc?formal/19-10-11
M - A Conceptual Overview of SBVR and the NIAM2007 Procedure to Specify a Conceptual Schema	formal/19-10-12	https://www.omg.org/cgi-bin/doc?formal/19-10-12

* Represents the Annexes that have changed since Version 1.4.

6.1.2 About the Normative Specification

The rest of this document contains the technical content of this specification.

The [SBVR Vocabulary](#) in Clauses 7 through 21 contains the SBVR terminological entries organized in focused topics that cover the subject filed of this specification: business vocabularies and business rules. Clauses 7 through 25 provide the foundation for the SBVR MOF Metamodel which is generated from Clauses 7 through 21 based on the transformation specified in Clause 23.

Clause 7, the [Vocabulary Registration Vocabulary](#) provides names and definitions for the vocabularies presented in the SBVR specification and of other vocabularies referenced by the SBVR specification.

As background for this specification, all readers are encouraged to first read Clause 8, which introduces the Semiotic/Semantic Triangle. It is the theoretic basis for the rest of the specification.

Clauses 8 through 21 provide the terminological entries that comprise the [SBVR Vocabulary](#). Parts of this vocabulary are intended for business people for use in business to communicate about:

- Business vocabularies, especially in Clauses 9 through 17 and 19 to 20.

- Business rules, especially in Clauses 16 through 20.

Clause 21 provides the terminological entries for the way that SBVR formulates the semantics of definitions and rules. It is not a vocabulary for business people but, rather, for those who work with the detailed specification of the meaning of business words and statements.

Clause 22 is an index of terminological entries in Clauses 8 through 21.

Clause 23 specifies how the SBVR MOF Metamodel is generated from the terminological entries in the [SBVR Vocabulary](#) and the [Vocabulary Registration Vocabulary](#) (Clauses 7 through 21).

Clause 24 presents the formal logics and mathematical underpinnings of the SBVR XML Metamodel. A concept in Clauses 8 through 21 marked with the symbol 'FL' is mapped to a formal logics concept in Clause 24.

Clause 25 lists supporting documents, such as an SBVR XMI XML Schema (XSD) for the SBVR MOF Metamodel.

Clauses 7 through 21 use SBVR Structured English to express the SBVR terminological entries. Annex A describes how the Structured English is interpreted such that SBVR is specified in terms of itself.

Much of the material in Parts II and III is illustrated by examples in the annexes, especially Annex G.

The clauses in this specification are organized in a logical manner and can be read sequentially. Short, highly-descriptive headings have been chosen with a focus on the essential subject matter, rather than on mechanics or underlying assumptions. The goal is to keep the topics as reader-friendly and unbiased as possible.

However, this is a reference specification and, as such, is also structured to support reading in a non-sequential manner. Consequently, extensive cross-references are provided to facilitate browsing and search.

6.2 Acknowledgements

The following companies submitted and/or supported parts of this specification:

- Adaptive
- Automated Reasoning Corporation
- Business Rule Solutions, LLC
- Business Rules Group
- Business Semantics Ltd
- Fujitsu Ltd
- Hendryx & Associates
- Hewlett-Packard Company
- InConcept
- LibRT
- KnowGravity Inc
- MEGA
- Model Systems
- Neumont University
- Perpetual Data Systems
- PNA Group
- Sandia National Laboratories

- The Rule Markup Initiative
- Unisys Corporation
- X-Change Technologies Group

Part II - Terminological Dictionary for Terminological Dictionaries and Rulebooks

This part contains the SBVR terminological entries that are the foundation for the SBVR MOF Metamodel. The clauses of Part II address focused topics that are of interest to different audiences.

Clause 7, the [Vocabulary Registration Vocabulary](#), provides names and definitions for the vocabularies presented in the SBVR specification and of other vocabularies referenced by the SBVR specification. Clause 8 introduces the Semiotic/Semantic Triangle. It is the theoretic basis for the rest of the specification.

Clauses 8 through 21 provide the terminological entries that comprise the [SBVR Vocabulary](#). Parts of this vocabulary are intended for business people for use in business to communicate about:

- Business vocabularies, especially in Clauses 9 through 17 and 19 and 20.
- Business rules, especially in Clauses 16 through 20.

Clause 21 provides the terminological entries for the way that SBVR formulates the semantics of definitions and rules. It is not a vocabulary for business people but, rather, for those who work with the detailed specification of the meaning of business words and statements.

Clause 22 is an index of terminological entries in Clauses 8 through 21.

Part II uses SBVR Structured English to express the SBVR terminological entries. Annex A describes how the Structured English is interpreted such that SBVR is specified in terms of itself. Although the Structured English is non-normative, its use in Clauses 7 through 21 has a normative interpretation described in sub-clause 23.6. Examples are in natural language and use no particular notation except where noted.

Any character in the UTF-8 character set may be used in these SBVR terminological entries. This includes readability characters such as smart quotes.

Much of the material in Part II is illustrated by examples in the annexes, especially Annex G.

The primary subjects of the [SBVR Vocabulary](#) fit between two other relevant subject areas described below.

1. **Expression** – things used to communicate (e.g., sounds, text, diagrams, gestures), but apart from their meaning — one expression can have many meanings.
2. **Representation** – the connection between expression and a meaning. Each representation ties one expression to one meaning.
3. **Meaning** – what is meant by a word (a concept) or by a statement (a proposition) – how we think about things.
4. **Extension** – the things to which meanings refer, which can be anything (even expressions, representations, and meanings when they are the subjects of our discourse).

Following are examples of how some things, like “driver,” cross through each subject area.

Extension	Meaning	Representation	Expression
The actual drivers of motor vehicles	Concept ‘driver’ — how we think of drivers, what characterizes them	Designation of the concept ‘driver’ by the signifier “driver”	The character sequence “driver”
		Definition of the concept ‘driver’ as “operator of a motor vehicle”	The character sequence “operator of a motor vehicle”
The actual City of Los Angeles, California – a real place	Individual noun concept ‘Los Angeles’ — how we think of that city, what distinguishes it from other places	‘Los Angeles’ as a designation for the individual noun concept of ‘Los Angeles’	The character sequence “Los Angeles”
For each car that is out of service, its actually being out of service	Characteristic applicable to a car, what is meant by a car being out of service	Verb concept wording ‘ <u>car</u> is out of service’ as a template for the characteristic with ‘ <u>car</u> ’ being a placeholder	The text “ <u>car</u> is out of service”
The actual state of affairs of it being obligatory in the EU-Rent business that it not rent to a barred driver	Proposition — the meaning of the statement “EU-Rent must not rent to a barred driver”	The statement, “EU-Rent must not rent to a barred driver,” having the proposition as its meaning	The character sequence “EU-Rent must not rent to a barred driver”

Another subject area of this vocabulary is reference schemes, which are ways people use information about something to identify it. For example, a city in the United States is identified by a name combined with the state it is in. The state is identified by its name or by a two-letter state code.

Representations provide a reference scheme for concepts and propositions because they are always tied to exactly one expression and to exactly one meaning. On the other hand, a single expression can have multiple meanings, a concept can have multiple expressions, a thing can be an instance of many concepts, and a proposition can be meant by many equivalent expressions.

A single representation can be tied to many speech acts, or to a single speech act, depending on how its expression is identified. For example, if the expression is a text or a sequence of words independent of any particular act of writing or speaking, the representation is independent in the same way. Conversely, if the expression is identified as belonging to a specific speech act, then the representation is tied to that speech act also.

Note: In the glossary entries below, the words “Concept Type: [role](#)” indicate that a general concept being defined is a role. Because it is a general concept, it is necessarily a situational role and is not a verb concept role.

7 Vocabulary Registration Vocabulary

7.1 Vocabulary Registration Vocabulary

This sub clause gives names of vocabularies and namespaces. Each one is either provided by SBVR or is external to SBVR but formally referenced.

Vocabulary Registration Vocabulary

General Concept: [vocabulary](#)
Language: [English](#)
Namespace URI: <https://www.omg.org/spec/SBVR/20160901/SBVR-Content-Model-for-SBVR.xml>

7.1.1 Vocabularies Presented in this Document

General Concept: [vocabulary](#)
Definition: [the vocabulary and definitional rules](#) that are defined in SBVR Clauses 7 through 21

SBVR Vocabulary

Definition: [the vocabulary](#) that is defined in SBVR Clauses 8 through 21

Formal Logic and Mathematics Vocabulary

General Concept: [vocabulary](#)
Note: See Clause 24 - Providing Semantic and Logical Foundations for Business Vocabulary and Rules.

Vocabulary Registration Vocabulary

General Concept: [vocabulary](#)
Note: This clause

7.1.2 External Vocabularies and Namespaces

ISO 1087-1 (English)

Definition: [the vocabulary](#) for the English language specified in [ISO1087-1]

ISO 6093 Number Namespace

Definition: [the namespace of designations](#) of decimal numbers specified in [ISO6093]
Namespace URI: <urn:iso:std:iso:6093:clause:8>

ISO 639-2 (English)

Definition: [the vocabulary](#) of English language names of languages specified in [ISO639-2] available at <http://www.loc.gov/standards/iso639-2/englangn.html>
Namespace URI: http://www.loc.gov/standards/iso639-2/php/English_list.php

ISO 639-2 (Alpha-3 Code)

Definition: the [vocabulary](#) of 3-letter codes for languages specified in [ISO639-2] available at <http://www.loc.gov/standards/iso639-2/langcodes.html>

Namespace URI: http://www.loc.gov/standards/iso639-2/php/code_list.php

UML2 Infrastructure

Definition: the [namespace](#) of [designations](#) for UML 2 Infrastructure concepts as defined by [UML2infr].

Unicode Glossary

Definition: the [vocabulary](#) presented in [Unicode4].

Uniform Resource Identifiers Vocabulary

Definition: the [vocabulary](#) presented in [IETF RFC 2396].

SBVR Vocabulary

General Concept: [vocabulary](#)

Language: [English](#)

Namespace URI: <https://www.omg.org/spec/SBVR/20160901/SBVR-Content-Model-for-SBVR.xml>

8 Linguistic Foundations

8.1 Things, Meanings, and Expressions

8.1.1 Semiotic/Semantic Triangle in SBVR Terms

This sub clause introduces the concepts that comprise one leg, ‘[meaning corresponds to thing](#)’, of the Semiotic/Semantic Triangle which was first introduced by Charles Sanders Peirce at the beginning of the twentieth century and later by (Ogden and Richards 1923). See “Ontology, Metadata, and Semiotics” [Sowa].

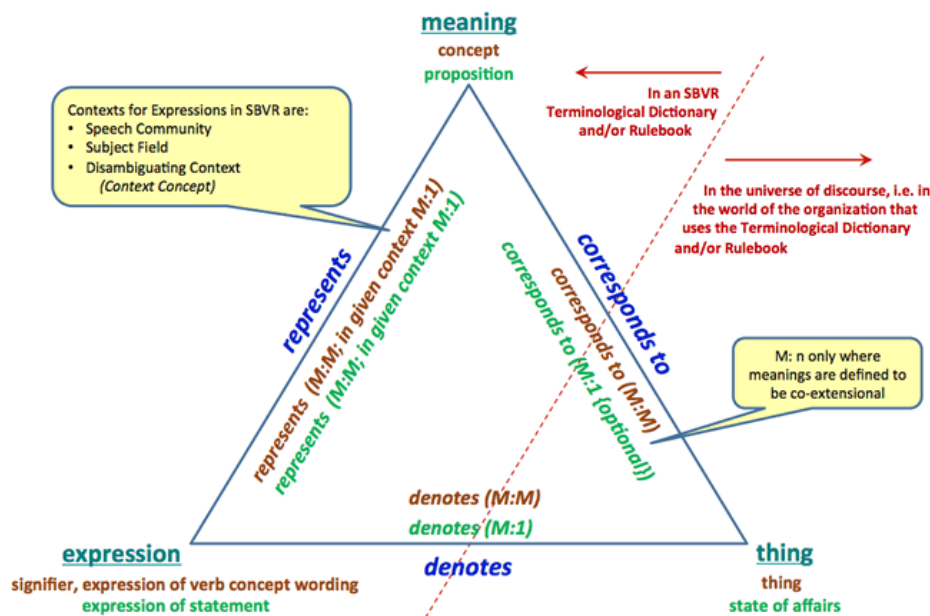

Figure 8.1 - Semiotic/Semantic Triangle in SBVR Terms

This diagram shows the SBVR terminological entries of this sub clause as explained in Annex C.

The Semiotic/Semantic Triangle is the theoretic basis for SBVR’s linguistics-based architecture in general and for the fundamental separation of representation (expression) from meanings in SBVR’s architecture. Being a linguistic-based standard the instances of concepts are the things in the universe of discourse, i.e., the world of the organization that uses the SBVR Business Vocabulary, and not concepts in the SBVR model.

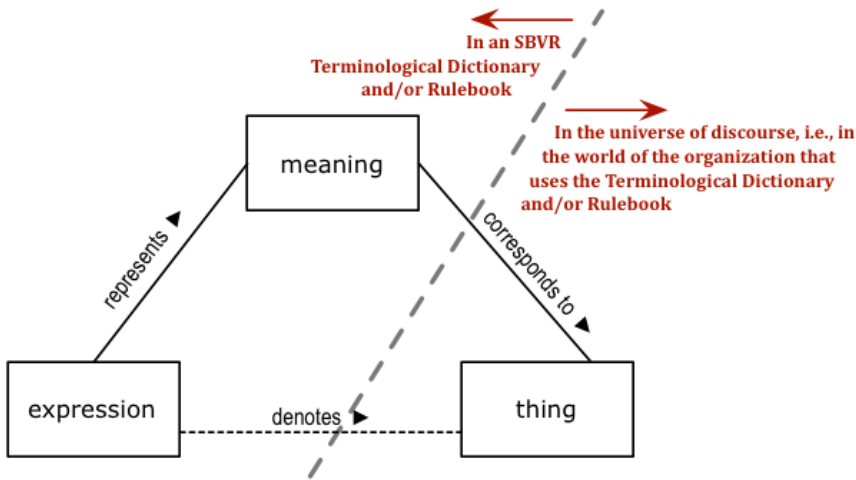

Figure 8.2 - Relating SBVR Concepts to the Semiotic/Semantic Triangle

This diagram shows the SBVR terminological entries of this sub clause as explained in Annex C.

8.1.2 SBVR Concepts for the Corners of the Semiotic/Semantic Triangle

meaning

Definition: what is meant by a word, sign, statement (*natural language meaning*), or [description](#); what someone intends to express or what someone understands

thing

Source: [ISO 1087-1 \(English\)](#) (3.1.1) ['object']

Definition: anything perceivable or conceivable

Note: Every other [concept](#) implicitly specializes the [concept](#) 'thing'.

Reference Scheme: [an individual noun concept that corresponds to the thing](#)

FL

expression

Definition: something that expresses or communicates, but considered independently of its interpretation

Example: the sequence of characters "car"

Example: the sequence of speech sounds (t), (r), and (ē)

Example: a smile

Example: a diagram

Example: The entire text of a book

8.1.3 SBVR Concepts for the Sides of the Semiotic/Semantic Triangle

meaning corresponds to thing

Definition: **the thing** is conceptualized by and is consistent with **the meaning**

Note: A concept corresponds to each instance of the concept. A proposition corresponds to a state of affairs (which might or might not be actual). A proposition that is true corresponds to an actuality.

Note: For some kinds of meanings this is a many-to-many relationship. For others it is many-to-one.

expression represents meaning

Definition: **the expression** portrays or signifies **the meaning**

8.2 Kinds of Thing

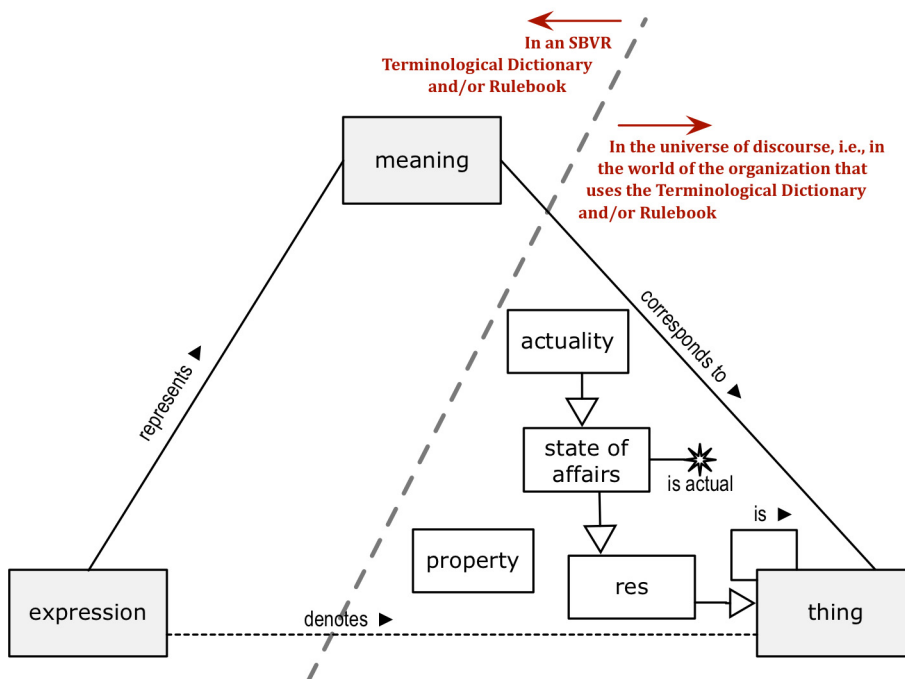

Figure 8.3 - Kinds of Thing

This diagram shows the SBVR terminological entries of this sub clause as explained in Annex C.

res

Definition: **thing that is not a meaning**

thing₁ is thing₂

Definition: **the thing₁ and the thing₂ are the same thing**

FL

property

- Definition: quality or trait actually belonging to a [thing](#) itself
- Dictionary Basis: a quality or trait belonging to a person or thing [[MWUD property](#)]
- Example: Consider three statements: “Meeting 1 starts at 1PM”, “Meeting 2 starts at 2PM”, “Meeting 1 ends at 2PM”. These describe three distinguishable properties: starting at 1PM, ending at 2PM and starting at 2PM. Each ‘property’ should not be confused with the verb concept role of the respective property association (which roles could be labeled “starting time” or “ending time”), because starting at 1PM is a different property than starting at 2PM. Also, the ‘property’ is not the thing that fills role (it’s not 1PM or 2PM), because starting at 2PM is a different property than ending at 2PM.
- Example: car group has daily price for member affiliation. This example involves a ternary property association, rather than a binary one. (Examples of “member affiliation” might include AARP membership, AAA membership, Costco membership, etc.)
- Note: By “actually” we mean “in the universe of discourse” (the things that we are talking about), not in a model of the universe of discourse. This meaning of “property” should not be confused with the meaning of “property” in an IT modeling context. There is no 1:1 relationship between “property association” in SBVR and “attribute” or “property” in a class or entity model.
- Note: There is no verb concept “[thing has property](#)” in SBVR for the following reason. Both of the noun concepts playing the roles of the verb concept would be in the Universe of Discourse - i.e., they would not pertain to meaning or representation. SBVR is about modeling what is said about the real world and not the real world itself. SBVR includes the ‘is-property-of’ category for verb concepts to specify which verb concepts are the connection between a concept in the role of a property and a concept in the role that has the property.

state of affairs

FL

- Definition: event, activity, [situation](#), or circumstance
- Reference Scheme: a [proposition that corresponds to the state of affairs](#)
- Reference Scheme: an [individual noun concept that corresponds to the state of affairs](#)
- Necessity: [No state of affairs is a proposition](#)
- Note: Any representation of a proposition may be used to denote the state(s) of affairs that it corresponds to. A proposition statement serves as a definite description for the state of affairs that the proposition corresponds to.
- Note: Some general noun concepts have extensions that are states of affairs; for example, the extension of ‘car being damaged during rental; is the states of affairs of rented cars being returned from rental damaged. A given state of affairs of this kind can be referenced by an individual noun concept (based on the general noun concept) such as ‘the car referenced by VIN xxxxx being damaged during the rental referenced by contract number yyyyyy’.
- Note: A [state of affairs](#) can be possible or impossible. Some of the possible ones are actualities. A [proposition corresponds to a state of affairs](#). A [state of affairs](#) either occurs or does not occur, whereas a [proposition](#) is either true or false. A state of affairs is not a meaning. It is a thing that exists and can be an instance of a concept, even if it does not happen.
- Example: EU-Rent owning 10,000 rental cars is a state of affairs to which the proposition “EU-Rent owns 10,000 rental cars”, corresponds.
- Example: It being obligatory that each rental have at most three additional drivers is a state of affairs to which the rule, “Each rental must have at most three additional drivers”, corresponds.

state of affairs is actual

FL

- Definition: **the state of affairs** happens (i.e., takes place, obtains)
- Note: The meaning of ‘is actual’ should not be confused with logical existence, which just means being something that is of interest in the universe of discourse. A potential state of affairs can ‘exist’ as a ‘thing’ in the universe of discourse and thereby be involved in relationships to other things (e.g., plans, desires, fears, expectations, perceptions, etc.) even if it is not actual, even if it never happens. A plan for, desire for, fear of, etc. a state of affairs is a different thing in the universe of discourse from the state of affairs itself that is planned for, desired or feared. The plan, desire fear, etc. can move between being actual and not actual. The state of affairs that is planned, desired or feared is corresponded to by a different proposition; it can, independently of the plan, desire or fear, also move between being actual and not actual.
- Note: If a state of affairs is perceivable (*real*) in a possible world, it is actual. If it is only conceivable (*planned, talked about*) and not perceivable in a possible world, it is not actual.
- Example: “The EU-Rent London-Heathrow Branch wants to be profitable”. Even when that branch is unprofitable, the previous statement can correspond to an actuality that involves the desired state of affairs that the EU-Rent London-Heathrow Branch is profitable. The desired state of affairs exists as an object of desire and planning regardless of whether there is ever an actual state of profitability. It exists and is involved in an actuality (an instance of the verb concept ‘company wants state of affairs’) even when the branch is unprofitable. The nature of the desired state of affairs is that it is a ‘desired state of affairs’ - conceived but not perceived. The actual state of affairs that the EU-Rent London-Heathrow Branch is profitable exists only when the branch is profitable. The nature of the actual state of affairs, if it exists, is that it is a happening in the world. It is perceived, as well as being conceived.

actuality

FL

- Definition: **state of affairs that is actual**
- Note: Actualities are states of affairs that actually happen, as distinct from states of affairs that don’t happen but nevertheless exist as subjects of discourse and can be imagined or planned.
- Example: Consider two unitary noun concepts, the first defined as “**state of affairs**” that EU-Rent London-Heathrow Branch is profitable” and the second defined as “**actuality**” that EU-Rent London-Heathrow Branch is profitable. The two definitions use the same objectification. The first concept always has an instance, regardless of profitability. The second concept has an instance (the same instance) only if the branch is profitable.

8.3 Kinds of Meaning

8.3.1 Kinds of Meaning

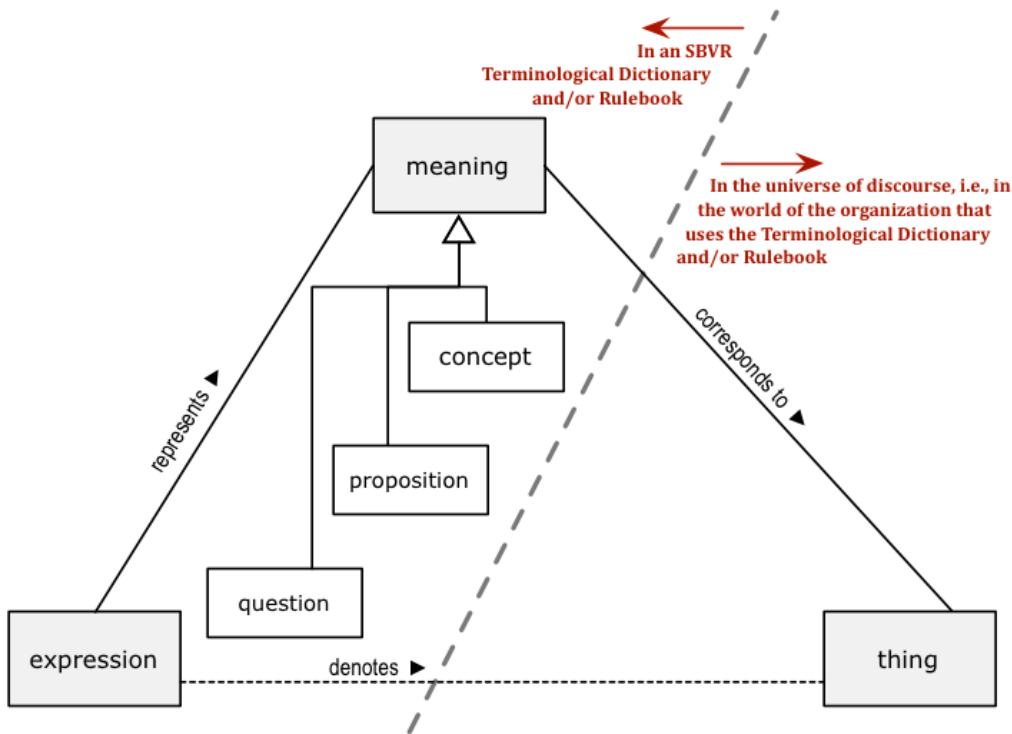

Figure 8.4 - Kinds of Meaning

This diagram shows the SBVR terminological entries of this sub clause as explained in Annex C.

concept

FL

Source: [ISO 1087-1 \(English\)](#) (3.2.1) [‘concept’]
 Definition: unit of knowledge created by a unique combination of [characteristics](#)
 General Concept: [meaning](#)
 Reference Scheme: a [designation of the concept](#)

proposition

FL

Definition: [meaning](#) of a declarative sentence that is not a paradox and that is invariant through all the paraphrases and translations of **the** sentence including synonymous [closed logical formulations](#)
 Note: A wff is a special case of statement in which there are no free occurrences of any variable, i.e., either it has constants in place of variables, or its variables are bound, or both.

- Source: [SubeGFOL]: proposition (2 & 3), Wff, Closed Wff
- Necessity: It is necessary that each [proposition that](#) is created by binding all the [verb concept roles of a given verb concept](#) means what [the definition of the verb concept](#) defines it to mean.
- Note: A verb concept role is played by a thing in the domain of discourse - the world of interest. A verb concept is 'bound' by specifying the thing(s) that play the verb concept role. Linguistically those things can be specified by a quantified noun phrase or by an individual noun concept or an expression or a pronoun that refers to a specific thing.
- Note: A proposition is always either true or false with respect to a possible world regardless of whether its truth value is known or is of interest.
- Note: Sub clause 21.3, Logical Formulations, describes one of the ways to understand the logical structure of propositions, including how concepts, such as individual noun concepts, general concepts, verb concepts and roles, fit into that structure.
- Note: The word "proposition" has two common meanings: first, a statement that affirms or denies something, and second, the meaning of such a statement. The concept '[proposition](#)' is here defined in the second sense and should not be confused with the statement of a [proposition](#).
- Note: The truth-value of the proposition is separate from the proposition (i.e., the meaning of the statement). The proposition means the same thing in every possible world, but the truth-value may be different in different possible worlds and is not necessarily relevant to every use of the proposition. Documenting the truth-value of a proposition is out of scope for SBVR and belongs to the domain of data management or rules enforcement.
- Reference Scheme: a [closed logical formulation that means the proposition](#)
- Reference Scheme: a [statement of the proposition](#)

question

- Definition: [meaning](#) of an interrogatory
- Note: The word "question" has two common meanings: first, a written or spoken expression of inquiry, and second, the meaning of such an inquiry. By the second definition, a single question could be asked in two languages. But by the first definition, using two language results in two expressions, and therefore, two questions. The concept '[question](#)' is here defined in the second sense (meaning) and should not be confused with the expression or representation of a [question](#).
- Reference Scheme: a [closed projection that means the question](#)

8.3.2 Kinds of Proposition

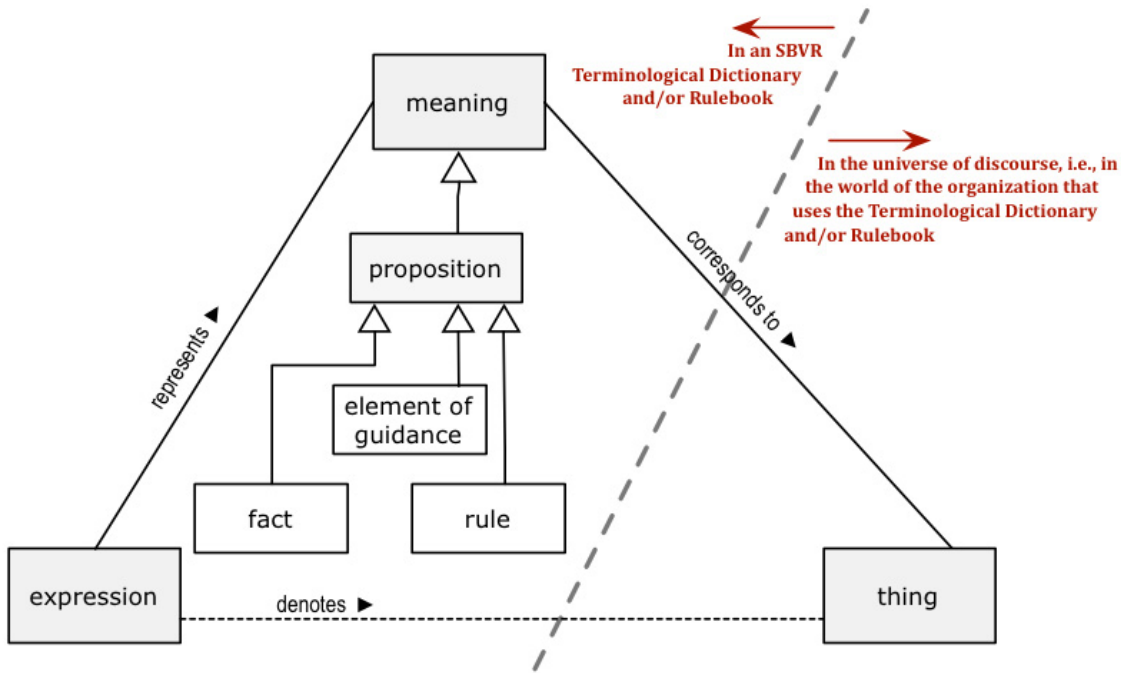

Figure 8.5 - Kinds of Proposition

This diagram shows the SBVR terminological entries of this sub clause as explained in Annex C.

fact

FL

Definition: [proposition](#) that is taken as true

Note: How one ascertains what is true, whether by assertion, observation, or other means, is outside the scope of this specification. However, taking a proposition as true must be consistent with epistemic commitment. The concept ‘[fact](#)’ is here defined to be consistent with the operations of truth-functional logic, which produce results based on true and false.

element of guidance

General Concept: [proposition](#)

Definition: means that guides, defines, or constrains some aspect of an enterprise

Note: This sense of ‘means’ (as in ‘ends and means’, rather than ‘is meant as’) arises from the Business Motivation Model [BMM].

Note: The formulation of an element of guidance is under an enterprise’s control by a party authorized to manage, control or regulate the enterprise, by selection from alternatives in response to a combination of assessments.

rule

FL

- Definition: [proposition](#) that *obligates* a given [state of affairs](#) or that *necessitates* a given [state of affairs](#)
- Dictionary Basis: one of a set of explicit or understood regulations or principles governing conduct or procedure within a particular area of activity ... a law or principle that operates within a particular sphere of knowledge, describing, or prescribing what is possible or allowable. [ODE]
- Note: The concept ‘proposition’ is defined in the SBVR Vocabulary in its linguistic sense as “meaning of a declarative sentence that ...” (see entry for [proposition](#)).
- Note: Rules fall into two fundamental categories, as follows:
- A behavioral business rule indicates something people or organizations are either obliged to do (an obligation), or prohibited from doing (a prohibition). A behavioral business rule serves to shape conduct or action and to provide a basis for judging the propriety of behavior.
 - A definitional rule indicates either what is always the case (a necessity) or is never the case (an impossibility). A definitional rule serves to specify a condition, in addition to those specified in the definition of the concept, that is true for every instance of the concept(s) to which the rule applies. As such it can be used as the basis for inference.

8.4 Kinds of Expression

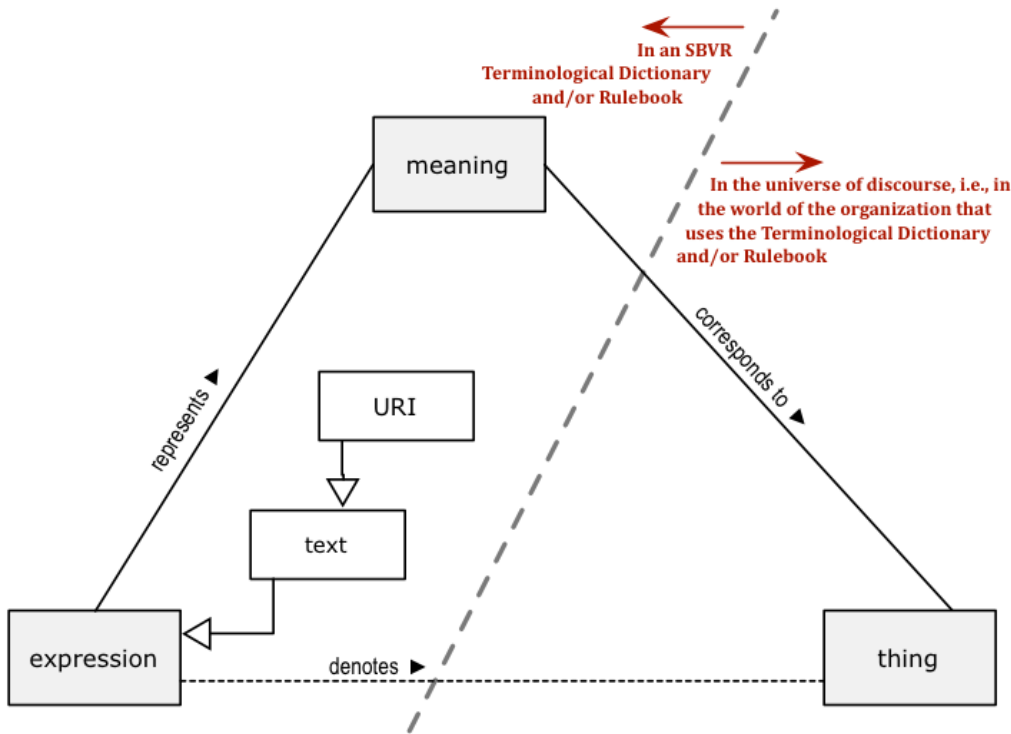

Figure 8.6 - Kinds of Expression

This diagram shows the SBVR terminological entries of this sub clause as explained in Annex C.

text

Source: [Unicode Glossary](#) ['Character Sequence']

General Concept: [expression](#)

Note: The [concept 'text'](#) has no explicit [reference scheme](#), but rather, is used as a target for reference schemes.

Note: A detailed vocabulary concerning text is provided by the Unicode specification. Taking the concept 'text' from the Unicode specification does not mean that a text is a Unicode encoding, but rather, it implies that a text can be represented by a Unicode encoding in electronic communications. Unicode encodings provide the common means of text representation in word processors, mail systems, the Internet, and so on. The encodings tend to be invisible to people writing and reading the text.

However, the character sets included in any given Unicode encoding are relevant to people writing and reading text, as they determine which characters are available for use in the text. Any character in the UTF-8 character set for the natural language used to write the SBVR

terminological entry or element of guidance entry may be used in the text of that entry. This includes readability characters such as smart quotes.

Note: A text is taken as a sequence of characters. Interpretation of markup is not addressed by this document.

URI

Source: [Uniform Resource Identifiers Vocabulary](#) [URI]
 Definition: [text](#) that identifies a resource as specified by [IETF RFC 2396]
 Synonym: [uniform resource identifier](#)
 Note: The [concept](#) 'URI' is introduced into this specification in order to provide a universal context for reference schemes.

8.5 Connections between Concepts and Things in the Business

8.5.1 Introduction

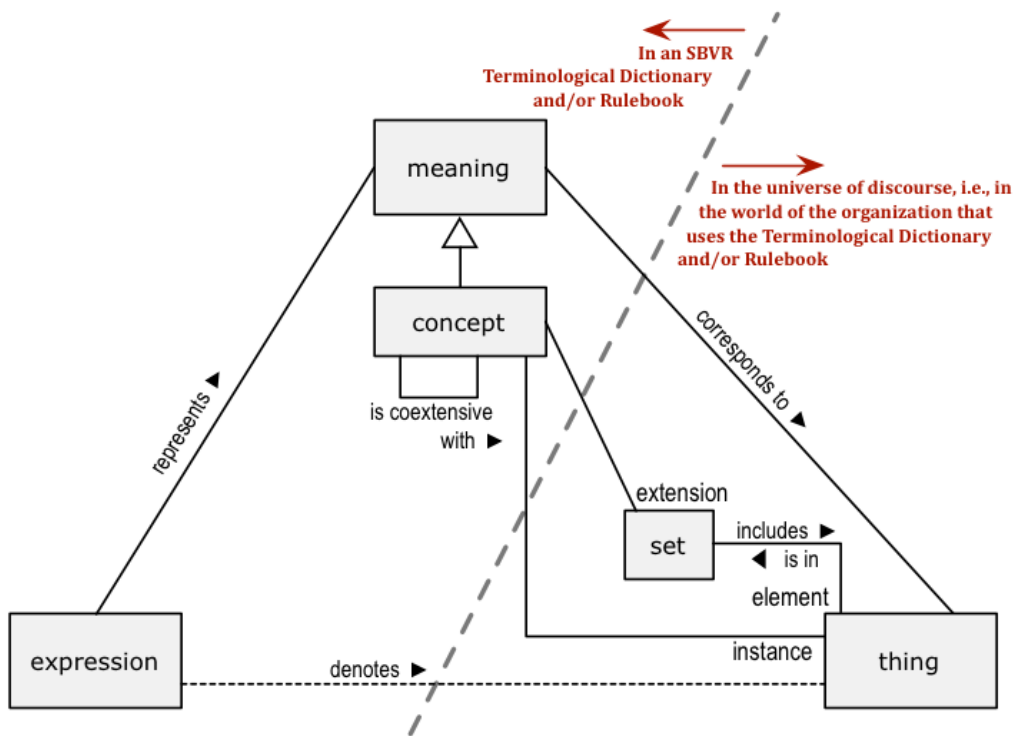

Figure 8.7 - Connections between Concepts and Things in the Business

This diagram shows the SBVR terminological entries of this sub clause as explained in Annex C.

8.5.2 Extensions

extension

FL

Source: [ISO 1087-1 \(English\)](#) (3.2.8) [‘extension’]
Definition: totality of objects [every [thing](#)] to which a [concept](#) *corresponds*
Concept Type: [role](#)
General Concept: [set](#)

concept has extension

FL

Definition: *the [extension](#) is the [set of things](#) to which the [concept](#) *corresponds**

concept₁ is coextensive with concept₂

FL

Definition: *the [extension of the concept₁](#) is always the [extension of the concept₂](#)*
Note: Semantic integrations between communities often involve recognizing where different concepts (having different intensions) have the same extensions in all possible worlds. Also, it is possible that concepts employing different methods of conceptualization have the same extension in all cases. For example, a noun concept that specializes the concept ‘actuality’ can be coextensive with a verb concept.
Example: The individual noun concept defined as “the thirtieth president of the United States” is coextensive with a general concept defined as “president of the United States in 1925”. The two concepts have the same extension (which includes only Calvin Coolidge) but they are different concepts.

8.5.3 Instances

instance

FL

Definition: *[thing that is in an \[extension of a concept\]\(#\)](#)*
Concept Type: [role](#)
Example: The actual City of Los Angeles is an [instance](#) of the [concept](#) ‘city.’ It is also the one [instance](#) of the [individual noun concept](#) ‘Los Angeles.’

concept has instance

FL

Definition: *the [concept](#) *corresponds to the* [instance](#)*

8.6 Connections between Kinds of Meaning and States of Affairs in the Business

8.6.1 Connections between Propositions and States of Affairs in the Business

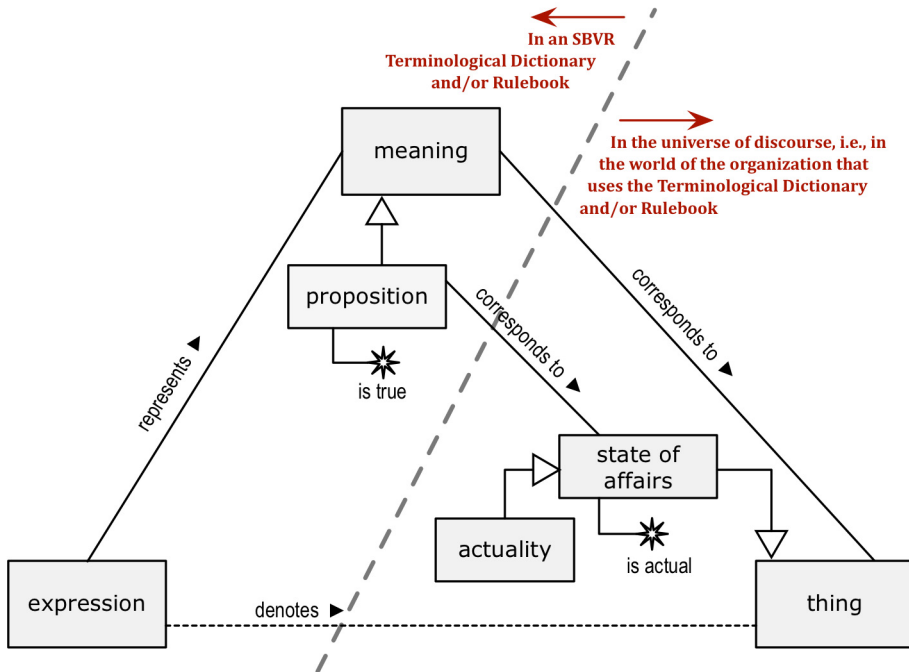

Figure 8.8 - Connections between Propositions and States of Affairs

This diagram shows the SBVR terminological entries of this sub clause as explained in Annex C.

proposition corresponds to state of affairs

General Concept: [meaning corresponds to thing](#)

Definition: [the state of affairs](#) is posited by [the proposition](#) and if the [state of affairs](#) were *actual*, the [proposition](#) would *be true*

Note: If the [proposition](#) is a simple proposition formulated using a single main verb, then the [state of affairs](#) can be understood as an instance of that verb concept that involves in each verb concept role of that verb concept the thing or things specified by the proposition as filling that verb concept role.

If the proposition is formulated using a more complex formulation involving implication, conjunction, or disjunction, the relationship between the proposition and the corresponding states of affairs is bound up with the way in which such propositions are determined to be true or false, as specified in Clauses 21 and 24. But ultimately each of those is based on the correspondence of the state of affairs to individual verb concepts.

8.6.2 Connections between Propositions and Actualities in the Business

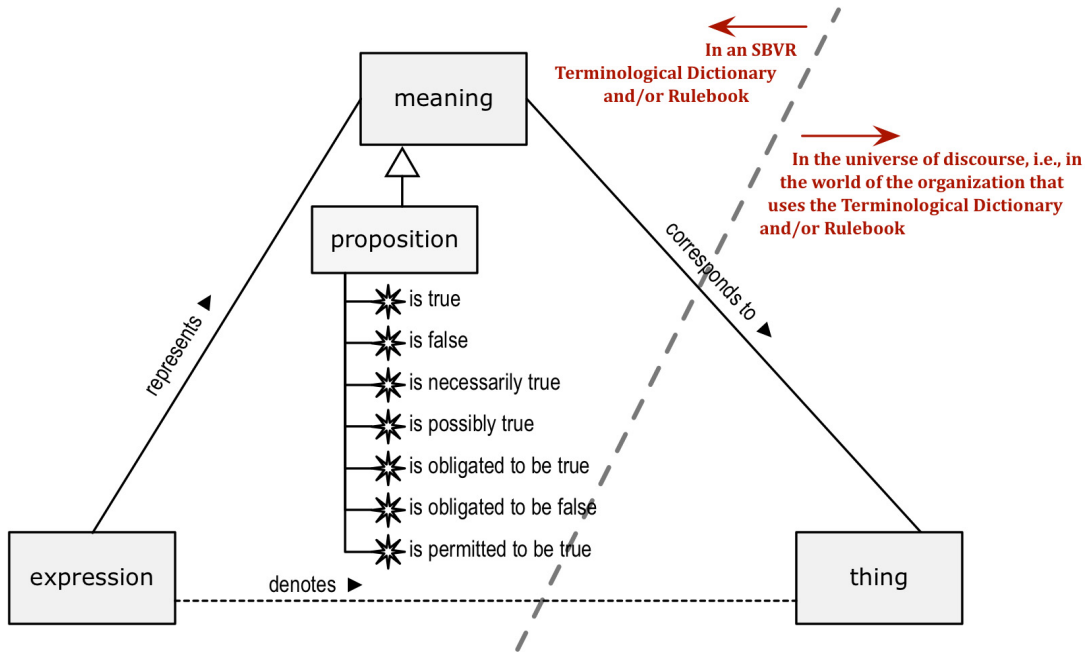

Figure 8.9 - Connections between Propositions and Actualities

This diagram shows the SBVR terminological entries of this sub clause as explained in Annex C.

proposition is true

FL

Definition: the state of affairs that the proposition corresponds to is actual

Note: A proposition is true if and only if the state of affairs to which it corresponds is actual, regardless of whether that state of affairs has been actual in the past or will be actual in the future.

Note: A proposition can be true with respect to one possible world and false with respect to another. See “possible world” in Clause 24.

proposition is false

FL

Definition: the state of affairs that the proposition corresponds to is not actual

proposition is necessarily true

FL

Definition: the proposition corresponds to an actuality in all possible worlds

Note: A proposition is considered to be necessarily true if it is true by definition - the definitions of relevant concepts make it logically impossible for the proposition to be false.

proposition is possibly true

Definition: the proposition corresponds to an actuality in some possible world

Possibility: A proposition that *is possibly true* corresponds to an actuality

proposition is obligated to be true

FL

Definition: the proposition corresponds to an actuality in all acceptable worlds

Note: The concept ‘acceptable world’ is described in Clause 24.

proposition is obligated to be false

FL

Definition: the proposition does not correspond to an actuality in any acceptable world

proposition is permitted to be true

FL

Definition: the proposition is not obligated to be false

Note: The concept ‘acceptable world’ is described in Clause 24.

8.6.3 Connections between Elements of Guidance and States of Affairs in the Business

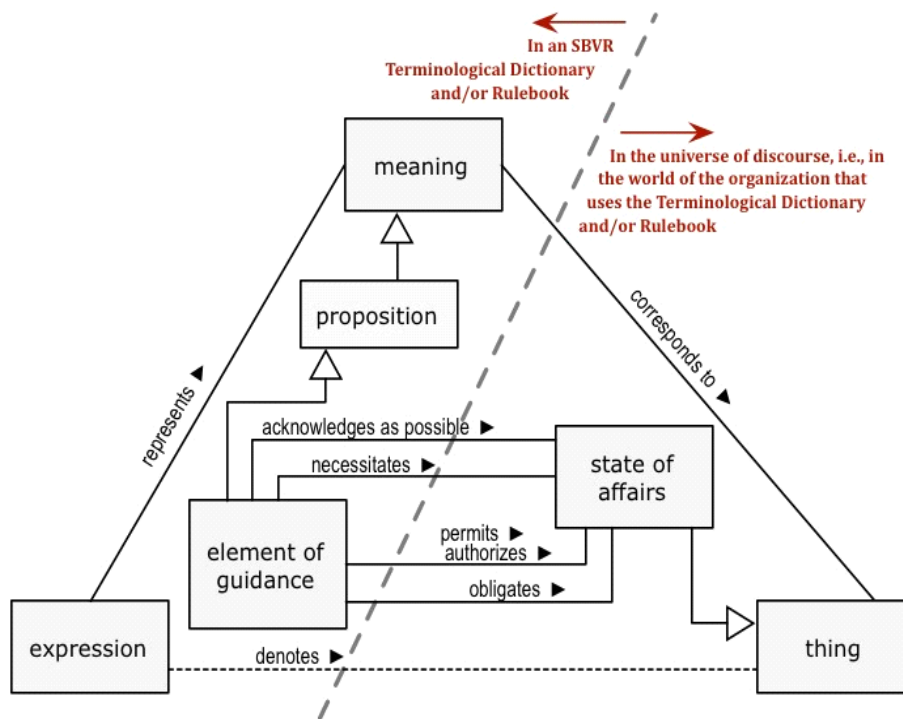

Figure 8.10 - Connections between Elements of Guidance and States of Affairs

This diagram shows the SBVR terminological entries of this sub clause as explained in Annex C.

element of guidance acknowledges as possible state of affairs

Definition: the element of guidance entails that the state of affairs can be an actuality in any possible world

element of guidance necessitates state of affairs

Definition: the element of guidance entails that the state of affairs *is always an actuality* in all possible worlds *or is never an actuality* in any possible world

element of guidance permits state of affairs

Definition: the element of guidance entails that the state of affairs *may be an actuality* in any acceptable world

Synonymous Form: element of guidance authorizes state of affairs

element of guidance obligates state of affairs

Definition: the element of guidance entails that the state of affairs *must be an actuality* in all acceptable worlds *or must not be an actuality* in any acceptable world

8.6.4 Connections between Roles and the Things in the Business that Play Them

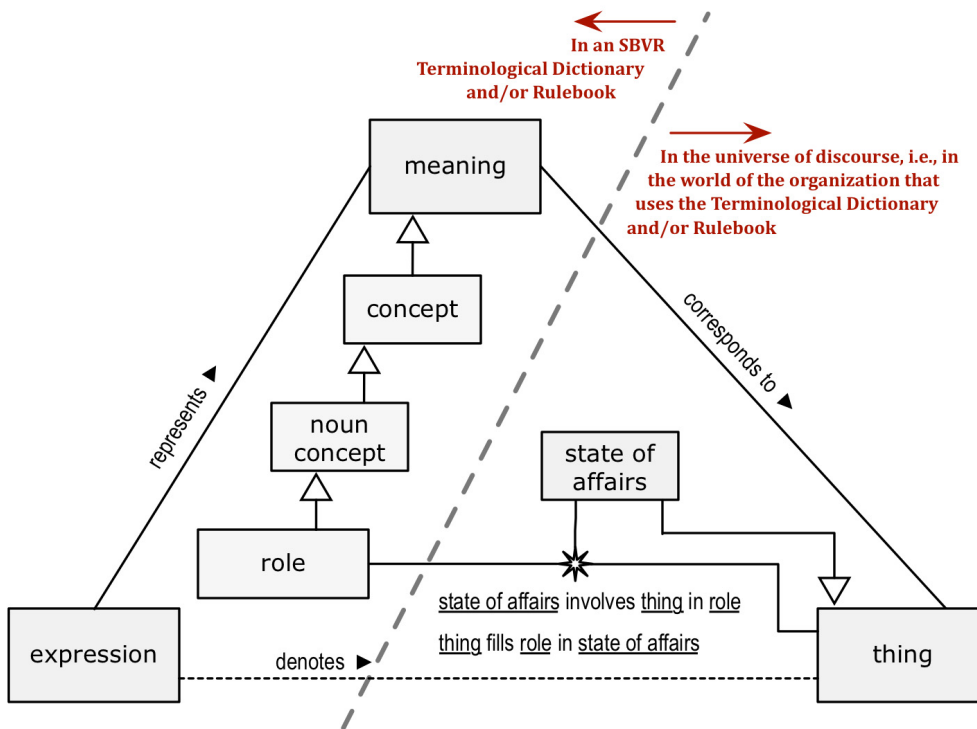

Figure 8.11 - Connections between Roles and the Things that Play Them

This diagram shows the SBVR terminological entries of this sub clause as explained in Annex C.

state of affairs involves thing in role

FL

- Definition: **the thing** plays **the role** in **the state of affairs**, and, if **the role is a verb concept role** and **the state of affairs is an actuality**, **the state of affairs is an instance of the verb concept that has the role**
- Synonymous Form: **thing fills role in state of affairs**
- Note: If the role is a general concept, it is necessarily a **situational role** and the state of affairs is a “situation” for which the role is defined (see 14.3.2).
- Note: This verb concept is used to capture the fact of involvement of a thing in an actuality that is an instance of a verb concept, or more generally, in a state of affairs whether or not it is an actuality.

8.7 Connections between Expressions and Things in the Business

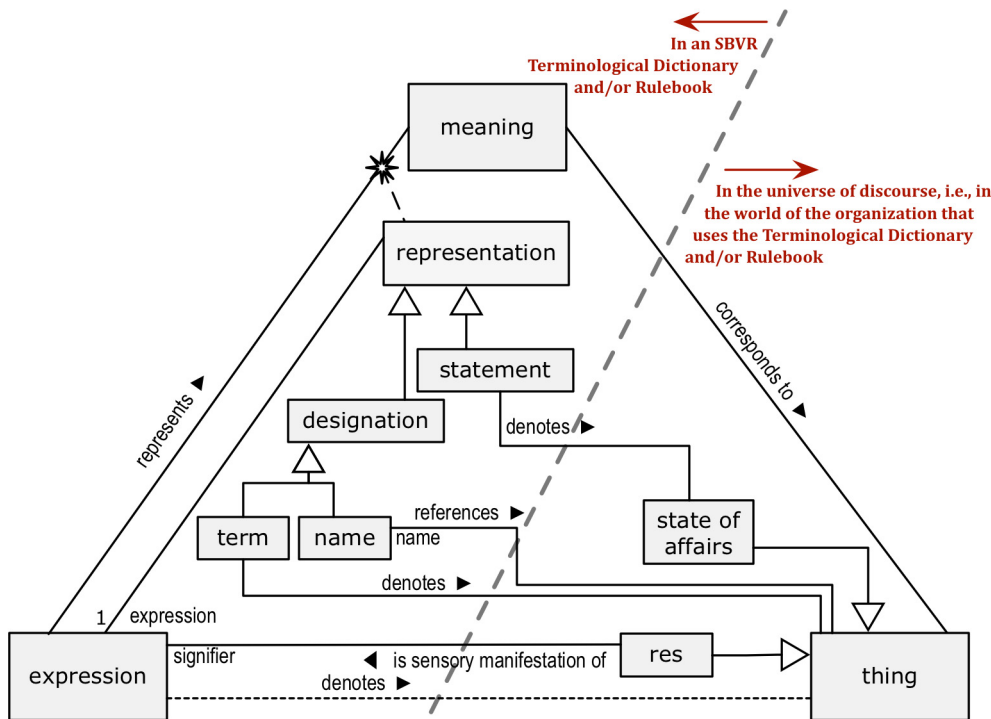

Figure 8.12 - Connections between Expressions and Things

This diagram shows the SBVR terminological entries of this sub clause as explained in Annex C.

res is sensory manifestation of signifier

term denotes thing

- Definition: **the thing is an instance of the concept that is represented by the term**

thing has name

- Definition: the thing is the instance of the individual noun concept that is represented by the name
- Synonymous Form: name *references* thing
- Note: A use of an individual noun concept by its name denotes the thing that is in the extension of the individual noun concept.

statement denotes state of affairs

- Definition: the statement *indicates* the state of affairs that is posited by the proposition that is expressed by the statement

8.8 Necessities Concerning Extension

The following statements of necessity apply to the relationships between a meaning and its extension. Other necessities stated in the context of the SBVR Vocabulary concern meanings and their representations. But the following necessities are about the correspondence of meanings to things in the universe of discourse; i.e., the world of the organization that uses the Terminological Dictionary and/or Rulebook.

- Necessity: Each concept *has* exactly one extension.
- Necessity: A thing is an instance of a concept if and only if the thing is in the extension of the concept.
- Necessity: Each instance of a verb concept is an actuality.
- Necessity: Each proposition *corresponds* to exactly one state of affairs.
- Necessity: Each proposition that is true *corresponds* to exactly one actuality.
- Necessity: Each actuality that is an instance of a verb concept *involves* some thing in each role of the verb concept.
- Necessity: Each thing that *fills* a role in an actuality is an instance of the role.
- Necessity: An actuality is an instance of a verb concept if the actuality *involves* a thing in a role of the verb concept.
- Necessity: If a concept *incorporates* a characteristic then each instance of the concept is an instance of the role of the characteristic.
- Necessity: Each instance of a role that *ranges over* a general concept is an instance of the general concept.
- Necessity: A thing is an instance of a verb concept role if and only if the thing *fills* the verb concept role in an actuality.
- Necessity: A thing *fills* a verb concept role in an actuality if and only if the actuality is an instance of the verb concept that *has* the verb concept role.
- Necessity: Each individual noun concept that *corresponds* to a thing always *corresponds* to that thing.
- Necessity: Each individual noun concept *corresponds* to at most one thing.

9 Communities and Authorities

9.1 Communities and Subcommunities

9.1.1 Community

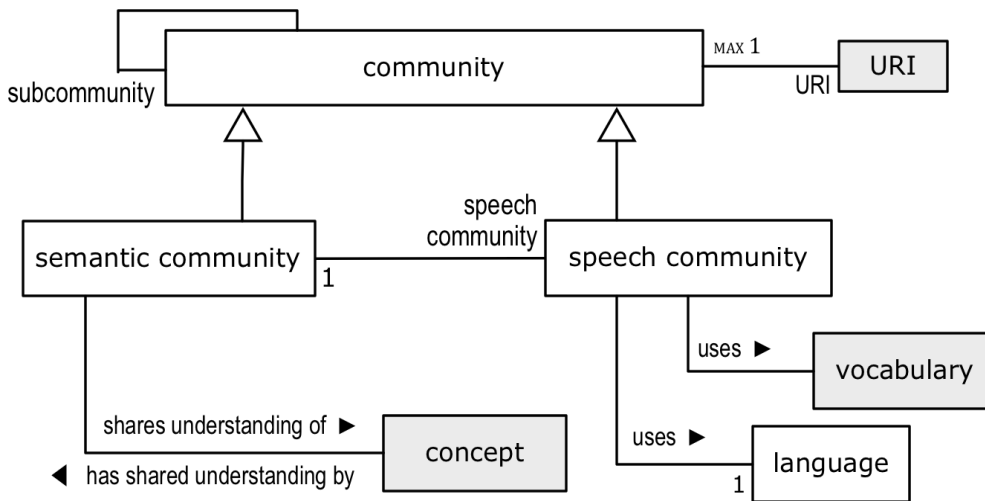

Figure 9.1 - Community and Kinds of Community

community

- Definition: group of people having a particular unifying characteristic in common
- Dictionary Basis: group of people having a religion, race, profession, or other particular characteristic in common [NODE 'community']
- Reference Scheme: a URI of the community
- Example: The Car Rental Community -- people who work in the car rental business
- Example: The EU-Rent Community -- all EU-Rent employees
- Example: The EU-Rent German Community -- employees of EU-Rent's German division

community has URI

- Definition: the URI uniquely identifies the community
- Necessity: Each URI is the URI of at most one community.

subcommunity

- Concept Type: role
- Definition: community that is a distinct grouping within another community
- Dictionary Basis: distinct grouping within a community [NODE 'sub-community']

community has subcommunity

Definition: the subcommunity is a distinct grouping within the community

9.1.2 Kinds of Community

semantic community

Definition: community whose unifying characteristic is a shared understanding (perception) of the things that they have to deal with

Example: The EU-Rent Community -- those who share the body of concepts about general and specific things of importance to the EU-Rent business.

semantic community shares understanding of concept

Synonymous Form: concept has shared understanding by semantic community

speech community

Definition: subcommunity of a given semantic community whose unifying characteristic is the vocabulary and language that it uses

Dictionary Basis: group of people sharing a characteristic vocabulary, and grammatical and pronunciation patterns for use in their normal intercommunication [W3ID 'speech community']

Example: The EU-Rent German Community shares the German-based vocabulary of designations used in EU-Rent's business. The designations include German words for EU-Rent's concepts plus designations adopted from other languages.

semantic community has speech community

Necessity: Each speech community is of exactly one semantic community.

language

Definition: system of arbitrary signals (such as voice sounds or written symbols) and rules for combining them as used by a nation, people, or other distinct community

Source: based on AH

Note: A language can be a natural language or an unnatural one, such as a computer language or a system of mathematical symbols.

Note: A language is often identified by its name. ISO provides names of many languages in ISO 639-2 (English) and provides short (at most 3 letters) language-independent codes in ISO 639-2 (Alpha-3 Code).

Example: English, French, German, Arabic

Example: Moroccan Arabic (a dialect of Arabic)

Example: Unified Modeling Language (a graphical modeling language)

speech community uses language

Definition: the speech community communicates in the language

Necessity: Each speech community uses exactly one language.

9.2 Authorities

Certain organizations, called *authorities*, have the need and the standing to create and adopt elements of guidance. Such organizations are not merely communities – they must conduct business in some organized fashion.

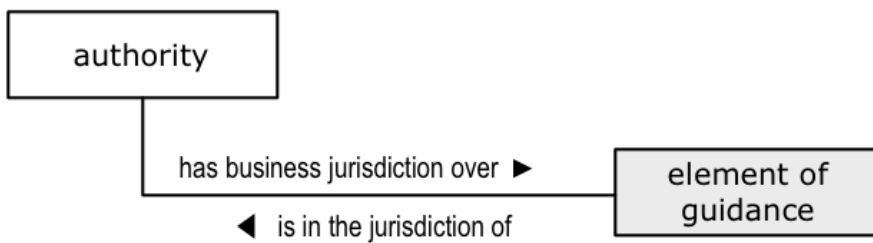

Figure 9.2 - Authority

authority

- Definition: organization with the standing to create or adopt [elements of guidance](#)
- Dictionary Basis: power to require and receive submission : the right to expect obedience : superiority derived from a status that carries with it the right to command and give final decisions [MWUD ; [authority' 2a](#)]
- Example: power to influence thought and opinion [MWUD ; [authority' 3a](#)]
a business (e.g., EU-Rent), a governmental body, a standards organization, a professional society, a club, a homeowner's association
- Note: People who create, adopt or use elements of guidance must understand the concepts on which they are based. Therefore, any person working within an authority who is involved in creating, adopting, and/or using an element of guidance must be a member of the semantic community for each concept referenced within the statement(s) for such element of guidance.
- Note: An authority might be a specialist body that creates elements of guidance for other authorities to adopt, rather than applying the elements of guidance itself.
- Note: The group of people and organizations to which given elements of guidance apply is often broader than the authority that has jurisdiction over the elements of guidance. Example: The group of people to whom the elements of guidance of an airline frequent-flyer program apply is much wider than the authority (airline or airline suborganization) that has jurisdiction over those elements of guidance.
- Note: It is possible and common for a person or organization to be subject to business rules of more than one authority.

authority has business jurisdiction over element of guidance

- Synonymous Form: [element of guidance is in the jurisdiction of authority](#)
- Definition: [the authority defines the element of guidance or adopts the element of guidance](#)

10 Characteristics

10.1 Introduction

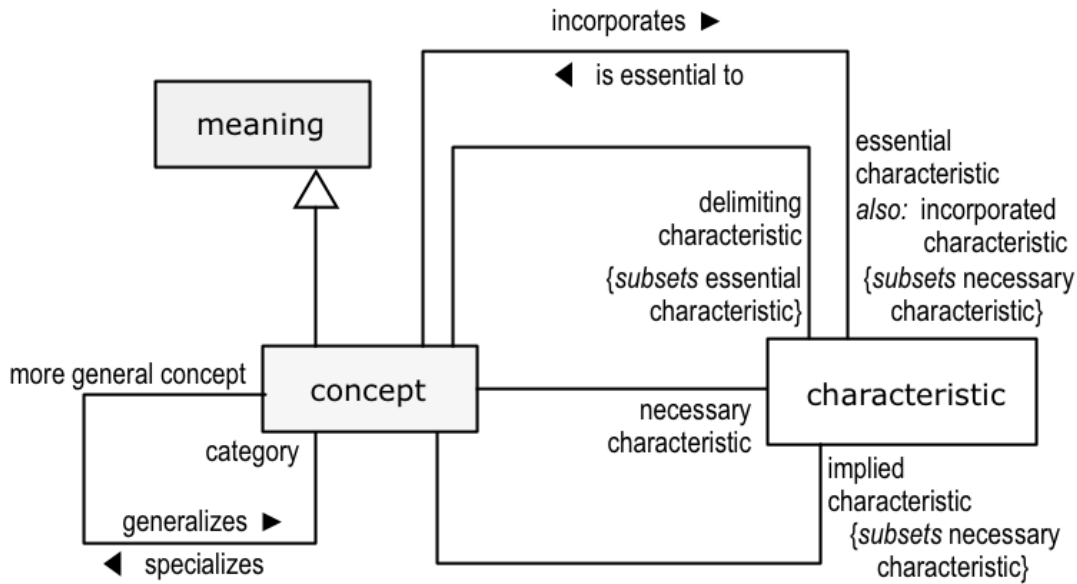

Figure 10.1 - Characteristics

10.2 Characteristic

characteristic

FL

- Definition: [verb concept](#) that **has exactly one role**
- Source: [ISO 1087-1 \(English\)](#) (3.2.4) [[characteristic](#)']
- Definition: abstraction of a [property](#) of an object [[thing](#)] or of a [set](#) of objects
- Synonym: [unary verb concept](#)
- Example: The [verb concept](#) 'shipment is late' whose instances are actualities of shipments being late. There is one instance of the verb concept for each shipment that is late.
- Note: A characteristic always has exactly one role, but it can be defined using verb concepts having multiple roles.
- Example: The [characteristic](#) 'driver is of age' with this definition: "the age of the driver is at least the EU-Rent Minimum Driving Age." The semantic formulation of this definition appears in the introduction to Clause 21 - Logical Formulation of Semantics.

10.3 Kinds of Characteristic

necessary characteristic

Definition: [characteristic](#) that is **always** true of **each** [instance of a given concept](#)
Concept Type: [role](#)

concept has necessary characteristic

Definition: **the** [necessary characteristic](#) is **always** true of **each** [instance of the concept](#)
Example: If the characteristic ‘[car](#) is small’ is a necessary characteristic of the concept ‘compact car’, then every compact car is always small.

essential characteristic

Source: [ISO 1087-1 \(English\)](#) (3.2.6) [‘essential characteristic’]
Definition: [characteristic](#) which is indispensable to understanding **a** [concept](#)
Synonym: [incorporated characteristic](#)
Concept Type: [role](#)

concept incorporates characteristic

FL

Definition: **the** [characteristic](#) is an abstraction of **a** [property](#) of **each** [instance of the concept](#) and is one of [the characteristics](#) that makes up [the concept](#)
Synonymous Form: [characteristic is essential to concept](#)
Synonymous Form: [concept has essential characteristic](#)
Concept Type: [is-property-of verb concept](#)

Note: Every characteristic incorporated by a concept is a necessary characteristic of the concept, but not every necessary characteristic of the concept is incorporated by the concept. Only those that are part of what makes up the concept are considered to be incorporated. Given an intensional definition of a concept, incorporated characteristics include all of these:

1. characteristics incorporated by the definition’s more general concept (recursively)
2. the definition’s delimiting characteristics
3. characteristics intrinsic to the delimiting characteristics (see example below)
4. any conjunctive combination of any of the characteristics above

Given an extensional definition, one that uses disjunction, characteristics that are found on each side of the disjunction are incorporated characteristics. Two definitions can define the same general concept by producing the same set of incorporated characteristics. The two definitions can directly identify different sets of incorporated characteristics (1 and 2 above) that are sufficient to determine the others (3 and 4 above). The way incorporated characteristics fall into 1 through 4 above can differ from one definition to another while producing the same overall set.

Example: The concept “wrecked rental car”, defined as “rental car that is nonoperational due to being in an accident”, incorporates the following characteristics:

1. characteristics incorporated by the more general concept ‘rental car’ - e.g., being a car, being a vehicle, being rentable, and (combining them all) being a rental car
2. the delimiting characteristic: being nonoperational due to being in an accident

3. characteristics intrinsic to the delimiting characteristics - e.g., being nonoperational and having been in an accident
4. all conjunctive combinations of the characteristics given above - e.g., being a nonoperational vehicle, being a wrecked car

Example: The [concept](#) ‘qualified driver’ incorporates the [characteristic](#) ‘driver is licensed’ because it is necessary (by the definition of ‘qualified driver’) that each qualified driver is licensed.

delimiting characteristic

Source: [ISO 1087-1 \(English\)](#) (3.2.7) [[delimiting characteristic](#)]
 Definition: [essential characteristic](#) used for distinguishing a [concept](#) from related [concepts](#)
 Concept Type: [role](#)
 Note: Delimiting characteristics of a concept are inherited as essential characteristics by all categories of that concept.

implied characteristic

Definition: [necessary characteristic of a given concept that is not incorporated by the concept](#)
 Concept Type: [role](#)
 Necessity: A [concept](#) has an [implied characteristic](#) only if it follows by [logical implication](#) from some combination of incorporations of [characteristics](#) by [concepts](#) and/or [definitional rules](#) that the [characteristic](#) is [always](#) attributed to [each instance of the concept](#).

concept has implied characteristic

Definition: [the implied characteristic is a necessary characteristic of the concept and the concept does not incorporate the implied characteristic](#)

10.4 Concept Generalization/Specialization

more general concept

Source: [ISO 1087-1 \(English\)](#) (3.2.15) [[generic concept](#)]
 Definition: [concept](#) in a generic relation having the narrower intension
 Concept Type: [role](#)
 Note: The narrower intension of a [more general concept](#) means that the [more general concept](#) [incorporates](#) fewer [characteristics](#) than any of its [categories](#). Thus, it is possible that a [more general concept](#) has a larger [extension](#) than its [categories](#).

category

Source: [ISO 1087-1 \(English\)](#) (3.2.16) [[specific concept](#)]
 Definition: [concept](#) in a generic relation having the broader intension
 Concept Type: [role](#)
 Dictionary Basis: secondary or subordinate category [[NODE](#) ‘subcategory’]
 Note: The broader intension of a [category](#) means that the [category](#) [incorporates](#) more [characteristics](#) than its [more general concept](#). Thus, it is possible that a [category](#) has a smaller [extension](#) than its [more general concept](#).

concept₁ specializes concept₂

FL

- Definition: the concept₁ *incorporates each characteristic that is incorporated by the concept₂ and the concept₁ incorporates at least one characteristic that is not incorporated by the concept₂*
- Synonymous Form: concept₂ *generalizes* concept₁
- Synonymous Form: concept₁ *has more general concept*
- Synonymous Form: concept₂ *has category₁*
- Note: The extension of a concept that specializes another is always a subset of the extension of the other, but not necessarily a proper subset. The differentiator that makes one concept more specific than the other is conceptual and does not necessarily restrict the extension of the concept.
- Example: The noun concept ‘whole number’ specializes the noun concept ‘integer’, the differentiator being that whole numbers are nonnegative.
- Example: The individual noun concept ‘Los Angeles’ specializes the concept ‘city’, the differentiator being that Los Angeles is one particular city in California.

11 Concepts

11.1 Noun Concepts

11.1.1 Introduction

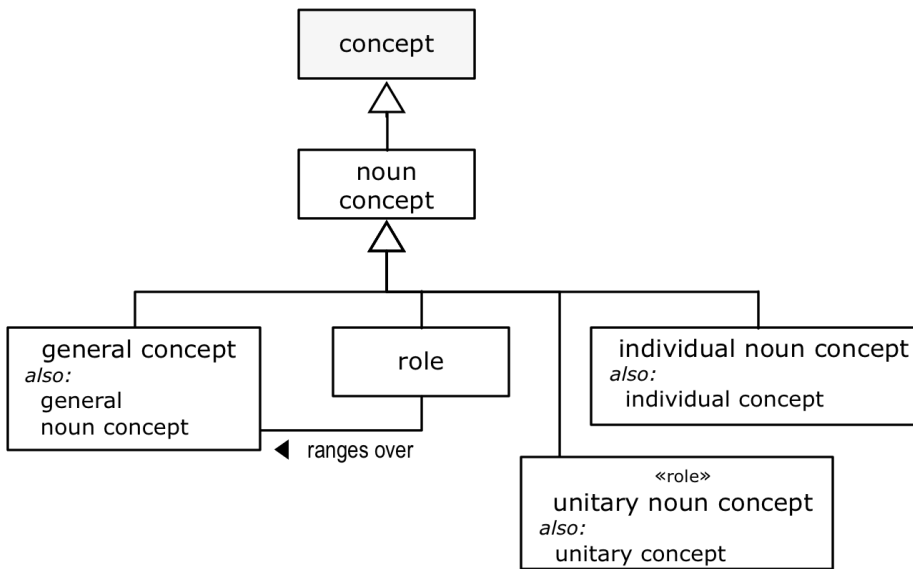

Figure 11.1 - Noun concepts

This diagram shows the SBVR terminological entries of this sub clause as explained in Annex C.

11.1.2 Noun Concept

noun concept

FL

Definition: [concept](#) that *is the meaning* of a noun or noun phrase

Concept Type: [concept type](#)

Reference Scheme: [a closed projection](#) that *defines the* [noun concept](#)

11.1.3 General Noun Concepts

general concept

Synonym: [general noun concept](#)

Definition: [noun concept](#) that classifies [things](#) on the basis of their common [properties](#)

Source: based on [ISO 1087-1 \(English\)](#) (3.2.3) [‘general concept’]

Concept Type: [concept type](#)

Necessity: [The set of characteristics that are incorporated by a general concept is not the set of characteristics that are incorporated by another general concept.](#)

Note: A general concept incorporates a set of characteristics which are a unique combination that distinguishes that general concept from all other general concepts. See ‘[concept incorporates characteristic](#)’. If a general concept A and a general concept B have the very same incorporated characteristics, they are the same concept. If they have the very same necessary characteristics, they are logically equivalent and they denote the same things in all possible worlds.

Example: the concept ‘rental car’ corresponding to cars that are rented

Example: the concept ‘car’, the concept ‘number’, the concept ‘person’

[role](#)

FL

Definition: [noun concept that corresponds to things](#) based on their playing a part, assuming a function or being used in [some situation](#)

Concept Type: [concept type](#)

Example: the [role](#) ‘[drop-off location](#)’ of the verb concept ‘[shipment](#) has [drop-off location](#)’

Example: the [role](#) ‘[shipment](#)’ of the verb concept ‘[shipment](#) has [drop-off location](#)’, which should not be confused with the general concept ‘[shipment](#)’ (which the role ranges over)

Example: the [role](#) ‘sum’ – a [role](#) of a number in relation to a set of numbers

Note: A role can be a general concept or a verb concept role. A role is always understood with respect to actualities of a particular verb concept or to other particular situations.

[role ranges over general concept](#)

Definition: [each characteristic that is incorporated by the general concept is incorporated by the role](#)

Note: Saying that a role ranges over a general concept is similar to saying the role specializes the general concept in that the role incorporates every characteristic incorporated by the general concept, and therefore, each instance of the role is necessarily an instance of the general concept. But “ranges over” is different in that it allows that both the role and the general concept incorporate the same characteristics - the general concept can incorporate a characteristic that its instances fill that role.

Note: Sometimes a role can be played by instances of any of a variety of types. For example, a role ‘customer’ might range over “person or organization”. This is not a case of a role ranging over multiple general concepts. Rather, it is a case of a role ranging over a single general concept that is defined extensionally. In this case the single general concept is defined as “person or organization”. In contrast, saying a role ranges over multiple general concepts means that any thing that fills the role is always an instance of each of those general concepts. It is equivalent to saying the role ranges over a single, possibly anonymous, general concept whose incorporated characteristics are the union of those incorporated by the multiple general concepts.

Note: A general concept ranged over by a role can be a situational role.

Example: The role ‘[company](#)’ of the verb concept ‘[company](#) employs [person](#)’ ranges over the general concept ‘company’

11.1.4 Individual and Unitary Noun Concepts

unitary noun concept

Synonym:	unitary concept
Concept Type:	role
Definition:	noun concept that <i>corresponds to at most one</i> thing at a time
Concept Type:	concept type
Note:	A unitary noun concept has at most one instance at any given time in a given possible world, but the instance can change over time.
Note:	Different definite descriptions of the same thing can represent different unitary noun concepts that correspond to that thing.
Example:	The unitary noun concept ‘Air Force One’: the airplane that is carrying the President of the United States, which may be a different aircraft at different times.

individual noun concept

FL

Synonym:	individual concept
Dictionary Basis:	ISO 1087-1 (English) (3.2.2) [‘individual concept’]
Definition:	noun concept that <i>corresponds to at most one</i> thing in all possible worlds
Concept Type:	concept type
Necessity:	No individual noun concept <i>is a</i> general concept .
Necessity:	No individual noun concept <i>is a</i> verb concept role .
Note:	Individual noun concepts are unitary noun concepts whose extensions are necessarily invariant across all possible worlds.
Note:	While each referring individual noun concept has at most one and the same instance in all possible worlds, there can be multiple individual noun concepts that correspond to the same thing. Different definite descriptions of the same individual thing can represent different individual noun concepts that correspond to that thing. If an individual noun concept does not correspond to any thing in some world, it does not correspond to any thing in any possible world.
Note:	A full understanding of ‘individual noun concept’ requires a full understanding of the Necessities in sub clause 8.8
Example:	The individual noun concept ‘California’ whose one instance is an individual state in the United States of America.

11.2 Verb Concepts

11.2.1 Introduction

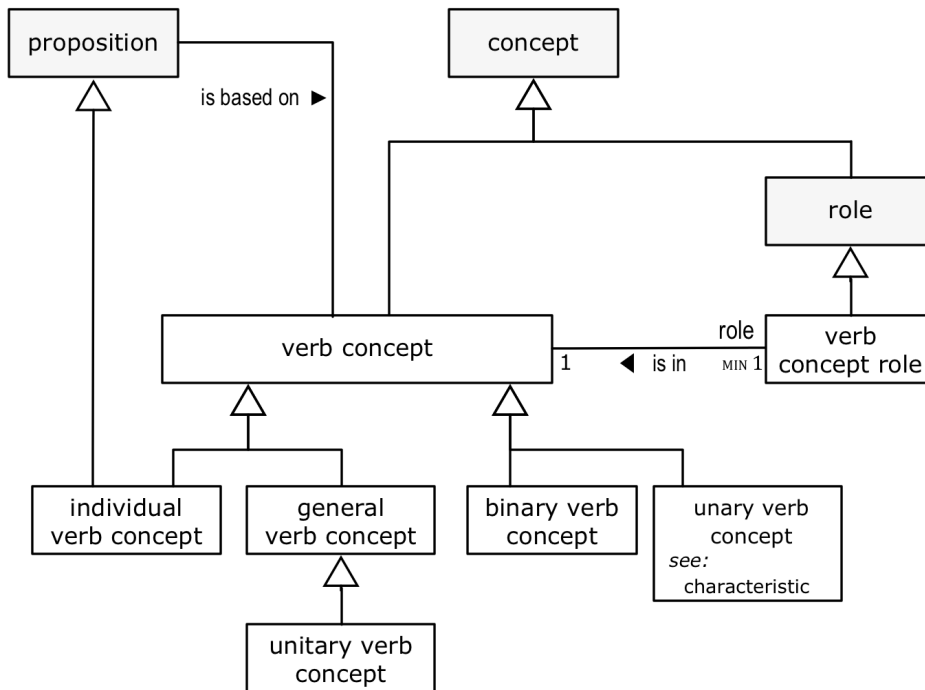

Figure 11.2 - Verb Concepts

This diagram shows the SBVR terminological entries of this sub clause as explained in Annex C.

11.2.2 Verb Concept

verb concept

FL

- Definition: concept that *specializes the concept* ‘state of affairs’ and that *is the meaning* of a verb phrase that involves *one or more verb concept roles*
- Dictionary Basis: [SubeGFOL]: Propositional function, [GFOL] Predicate
- Note: A propositional function becomes a proposition when it is closed; it is closed by binding it to a logical constant (an individual noun concept) or a quantified variable (that ranges over some possibly qualified noun concept).
- Note: Each instance of a verb concept is a state of affairs. For each instance, each role of the verb concept is one point of involvement of something in that state of affairs.
- Note: Two verb concept definitions define the same verb concept if they reveal the same incorporated characteristics and the same verb concept roles.

Concept Type:	concept type
Necessity:	Each verb concept <i>has at least one</i> verb concept role .
Necessity:	Each proposition that is created by binding all the verb concept roles of a given verb concept means what the definition of the verb concept defines it to mean.
Necessity:	The definition that represents each verb concept is consistent with and defines exactly the complete set of propositions that can be created by quantifying each verb concept role of the verb concept
Note:	A verb concept role is played by a thing in the domain of discourse - the world of interest. A verb concept is 'bound' by specifying the thing(s) that play the verb concept role. Linguistically those things can be specified by a quantified noun phrase or by an individual noun concept or by a pronoun that refers to a specific thing.
Reference Scheme:	a verb concept wording of the verb concept
Reference Scheme:	a closed projection that defines the verb concept

11.2.3 Verb Concept Role

[verb concept role](#)

Definition:	role that specifically characterizes its instances by their involvement in an actuality that is an instance of a given verb concept
Concept Type:	concept type
Reference Scheme:	a placeholder that represents the verb concept role
Reference Scheme:	a variable that maps to the verb concept role
Reference Scheme:	a characteristic that has the verb concept role
Necessity:	Each verb concept role is in exactly one verb concept .
Necessity:	No verb concept role is a general concept .
Note:	A verb concept role is fundamentally understood as a point of involvement in actualities that correspond to a verb concept. Its incorporated characteristics come from the verb concept - what the verb concept requires of instances of the role. It is possible that two verb concept roles incorporate the same characteristics, such as when a binary verb concept means the same thing when roles are reversed, as in ' person is married to person '.

[verb concept has role](#)

FL

Definition:	the role is an abstraction of a thing playing a part in an instance of the verb concept
Synonymous Form:	verb concept role is in verb concept

11.2.4 Verb Concepts and Propositions

[proposition is based on verb concept](#)

Definition:	the proposition is formulated using the verb concept
Example:	The EU-Rent business rule that is expressed as "It is obligatory that each rental specifies a car group." (or, in RuleSpeak, "A rental must have a car group.") is based on the EU-Rent verb concept ' rental specifies car group '.

11.2.5 Kinds of Verb Concept

binary verb concept

FL

- Definition: [verb concept](#) that *has exactly 2 roles*
- Example: The [verb concept](#) ‘[shipment](#) has [drop-off location](#)’ whose instances are actualities of shipments having drop-off locations.
- Example: The [verb concept](#) ‘[number](#) is greater than [number](#)’ whose instances are actualities of numbers being greater than other numbers, there being one instance for every pair of numbers where one is greater than the other.
- Note: A verb concept can have two roles that seem to be identical (e.g., ‘[person](#) is married to [person](#)’ where each role can be called ‘spouse’). Even though they incorporate the same characteristics, they are distinct in that they indicate two distinct points of involvement in each actuality the verb concept corresponds to.

unary verb concept

- See: [characteristic](#)

general verb concept

FL

- Definition: [verb concept](#) that *has at least one* open [verb concept role](#) that has not been closed with an [individual noun concept](#)
- Concept Type: [concept type](#)

unitary verb concept

FL

- Definition: [general verb concept](#) that *has exactly one instance* in a possible world at a given time
- Necessity: *Each role of a unitary verb concept ranges over a unitary noun concept.*
- Necessity: *At least one role of a unitary verb concept ranges over a unitary noun concept that is a general concept.*
- Note: Unitary verb concepts allow individual states of affairs that are needed in a business vocabulary to be included in a body of shared meanings.
- Note: Changes in the extensions of the unitary noun concepts that fill the roles of a unitary verb concept cause the unitary verb concept to correspond to a different state of affairs.
- Example: “The President (*a situational role*) flies to the alternate seat of government (*a situational role*) on Air Force One (*a situational role*)”. The single state of affairs in the extension changes as, over time, different people, places and aircraft fill the roles.
- Example: “the consolidated global account (*a situational role*) is filed in the base currency (*a situational role*) in the compliant format (*a situational role*)” specializes the verb concept “account is filed in currency in acceptable format”. It defines the unitary verb concept that currently has the extension “the consolidated global account is filed in Swiss Francs in XBRL”

individual verb concept

FL

- Concept Type: [verb concept](#) that *has each verb concept role* closed by an [individual noun concept](#) and that *corresponds to exactly one state of affairs* in all possible worlds at all (relevant) times
- Definition: [proposition](#) that is derived by closing *each role of a verb concept* with an [individual noun concept](#)
- Note: Individual verb concepts allow individual states of affairs that are needed in a business vocabulary to be included in a body of shared meanings.
- Necessity: *Each role of an individual verb concept is filled by an individual noun concept.*

Example: “EU-Rent was incorporated in Luxembourg in 1991” and “EU-Corp was incorporated in Geneva in 1993” are individual verb concepts that are derived from the verb concept “company was incorporated in jurisdiction in calendar year”.

Example: “EU-Corp has owned EU-Rent since 1993” is an individual verb concept that is derived from the verb concept “company has owned company since calendar year”.

11.3 Reference Schemes

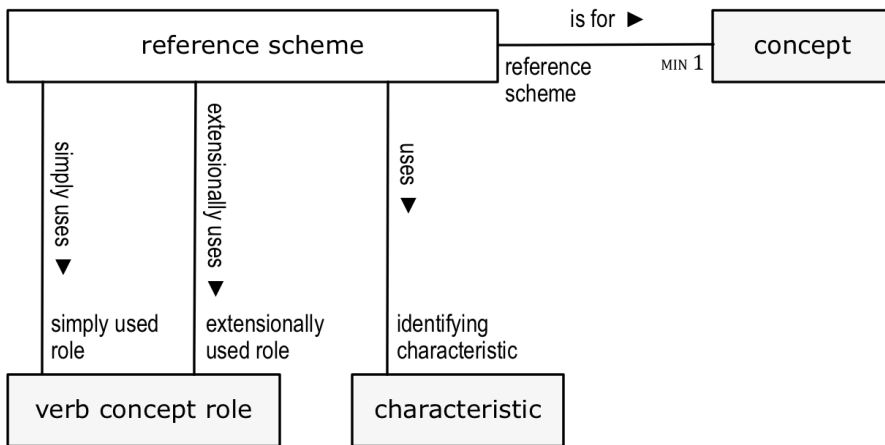

Figure 11.3 - Reference Scheme

This diagram shows the SBVR terminological entries of this sub clause as explained in Annex C.

reference scheme

FL

- Definition: chosen way of identifying **instances of a given concept**
- Note: A **reference scheme** is a way of referring to instances of a **concept** by way of related things that are either lexical or are otherwise identifiable. A reference scheme usually uses one or more verb concept roles of binary verb concepts in order to identify an instance of a concept from facts about the instance. A reference scheme can also use one or more characteristics.
- Note: A **reference scheme** can be partial or complete. It is complete if it can always be used to refer to every instance of a concept. An overall complete reference scheme for a concept can result from there being multiple partial reference schemes for that concept, its more general concepts, and its categories.
- Note: Choice of reference schemes must be based on uniqueness (providing an identifier that refers to exactly one thing), but it should consider more than uniqueness. It should also consider permanence – if the actualities considered by the scheme change often, then references can become invalid. A reference scheme should also not lead into an inescapable reference cycle where things only identify each other, but should lead either directly or indirectly to an expression. It should also consider convenience and relevance from a business perspective.
- Note: A verb concept role is used in a reference scheme in either of two ways. A simple use of a verb concept role involves a single instance of the verb concept role in each reference based on the

scheme. An extensional use of a verb concept role involves the entire set of related instances of the verb concept role in each reference based on the scheme.

Note: A reference scheme implies that there is uniqueness – that whatever facts are used to reference an individual thing uniquely identify that one thing.

Reference Scheme: the set of verb concept roles that are simply used by the reference scheme and the set of verb concept roles that are extensionally used by the reference scheme and the set of characteristics that are used by the reference scheme

reference scheme is for concept

FL

Definition: instances of the concept can be identified using the reference scheme

Synonymous Form: concept has reference scheme

Necessity: Each reference scheme is for at least one concept.

reference scheme simply uses verb concept role

FL

Definition: any given instance of the verb concept role, which is of a binary verb concept, serves as identification or partial identification of an instance of the concept having the reference scheme where the given instance is related by way of the binary verb concept that has the verb concept role

Synonymous Form: reference scheme has simply used role

Necessity: Each verb concept role that is simply used by a reference scheme is in a binary verb concept.

Example: A reference scheme for ‘car model’ simply uses the ‘name’ role of the binary verb concept ‘car model has name’. An example of a reference based on this reference scheme identifies a particular car model as having the name “Chevrolet Cavalier.” The meaning of the reference is an individual noun concept having this definition: the car model that has the name “Chevrolet Cavalier.”

reference scheme extensionally uses verb concept role

FL

Definition: a set of instances of the verb concept role, which is of a binary verb concept, serves as identification or partial identification of an instance of the concept having the reference scheme where the set is the set of all instances of the verb concept role related by way of the binary verb concept that has the verb concept role

Synonymous Form: reference scheme has extensionally used role

Necessity: Each verb concept role that is extensionally used by a reference scheme is in a binary verb concept.

Example: The reference scheme given above for the concept ‘reference scheme’ itself exemplifies extensional use of roles. Any particular reference scheme can be identified by the combination of what roles it simply uses, what roles it extensionally uses, and what characteristics it uses. For example, the reference scheme for ‘car model’ (in the example above) is identified by the facts that it simply uses only the ‘name’ role of the binary verb concept ‘car model has name’, it extensionally uses no roles and it uses no characteristics.

reference scheme uses characteristic

FL

Definition: having or not having the characteristic serves as identification or partial identification of an instance of the concept having the reference scheme

Synonymous Form: reference scheme has identifying characteristic

Note: Reference schemes generally use a characteristic only in combination with one or more roles of binary verb concepts such that facts of those types about any referenced thing reduce the number matching instances down to two, one instance having the characteristic and not the other. A reference scheme using no more than a characteristic works only for the unusual case of a concept that always has at most two instances.

Example: A concept 'tire position', which has only four instances, has a reference scheme that uses two characteristics, 'tire position is in front' and 'tire position is on the right'. Any of the four positions can be identified by knowing whether or not it is in front and whether or not it is on the right. The meaning of a reference based on this scheme is an individual noun concept having the more general concept 'tire position' and having a delimiting characteristic that is either being in front or not being in front and another delimiting characteristic that is either being on the right or not being on the right.

12 Representations

12.1 Representations

12.1.1 Representation

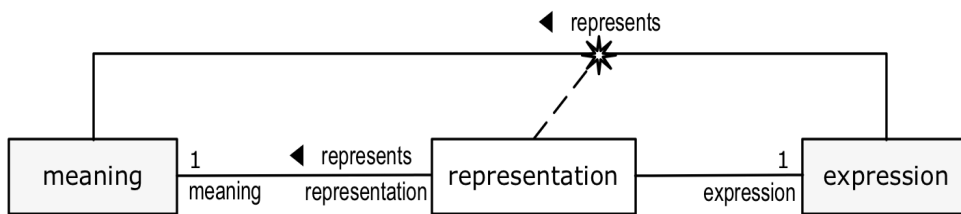

Figure 12.1 - Representation

This diagram shows the SBVR terminological entries of this sub clause as explained in Annex C.

representation

Definition: actuality that a given expression represents a given meaning

Necessity: Each representation has exactly one expression.

Necessity: Each representation represents exactly one meaning.

representation has expression

representation represents meaning

Synonymous Form: meaning has representation

Synonymous Form: representation has meaning

12.1.2 Representation Formality

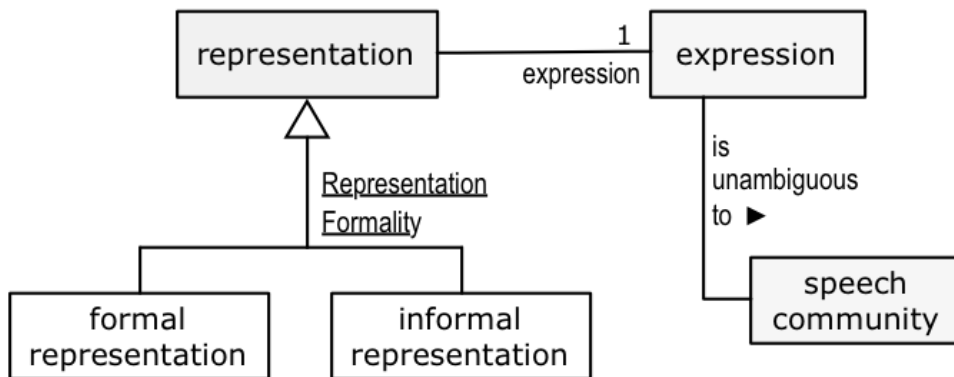

Figure 12.2 - Representation Formality

expression is unambiguous to speech community

Definition: the expression is understood by each member of the speech community to represent exactly one and the same meaning

Note: In SBVR, a fully and accurately styled expression is assumed to be unambiguous. (Formal assessment of the expression, of course, may find that it is not.) The verb concept “expression is unambiguous to speech community” is not used for such expressions.

Only informal statements (unstyled or partially styled) should use this verb concept. In communicating expressions, recipients need a sense of the viability of what is being communicated. Use of the verb concept to indicate that an expression is unambiguous indicates that an informal assessment has been made and that the meaning of the expression is thought to be clear.

Caution should be exercised in this regard. Even expressions thought to be self-evidently unambiguous may be found not to be so. Practitioners should generally err on the side of caution, especially in expressing elements of guidance.

representation formality

Definition: the segmentation of the concept ‘representation’ that classifies a representation based on whether or not it is ‘formal’

formal representation

Definition: representation in which every word is annotated (‘tagged’) in accordance with a notation that can be mapped to SBVR

Necessity: No formal representation is an informal representation.

Necessity: The concept ‘formal representation’ is included in Representation Formality.

informal representation

Definition: representation in which not every word is annotated (‘tagged’) in accordance with a notation that can be mapped to SBVR

Necessity: No informal representation is a formal representation.

Necessity: [The concept 'informal representation' is included in Representation Formality.](#)
 Note: Some of the words of an informal representation may be annotated -- i.e., defined, or 'tagged', terms, names, verbs, or keywords.

12.1.3 Representation Disambiguation

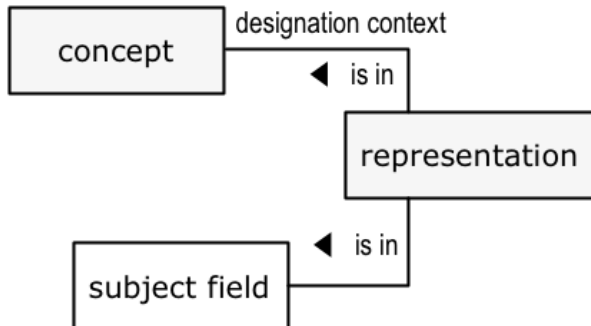

Figure 12.3 - Representation Contexts for Disambiguation

This diagram shows the SBVR terminological entries of this sub clause as explained in Annex C.

designation context

Concept Type: [role](#)
 Definition: [concept](#) that characterizes the domain of usage within which [the expression of a representation](#) has a unique [meaning](#) for [a given speech community](#)
 Example: When EU-Rent uses the term 'site':
 * within the context of the concept termed 'vehicle rental' (another EU-Rent term), it denotes EU-Rent's shared understanding of a 'place from which EU-Rent vehicles are picked up and returned'.
 * within the context of the concept termed 'vehicle maintenance' (another EU-Rent term), it denotes EU-Rent's shared understanding of a 'place where EU-Rent's vehicle fleet is serviced and repaired'.
 Example: When EU-Rent uses the term 'customer':
 * within the context of the concept termed 'vehicle rental' (another EU-Rent term), it denotes EU-Rent's shared understanding of 'rental-customer-ness' (Definition: 'individual who currently has a EU-Rent car on rental, or has a reservation for a future car rental, or has rented a car from EU-Rent in the past 5 years').
 * within the context of the concept termed 'vehicle sales' (another EU-Rent term), it denotes EU-Rent's shared understanding of 'car-purchaser-ness' (Definition: 'individual who has purchased at least one car from EU-Rent that is still within its warranty period').

representation is in designation context

Definition: [the representation](#) is recognized and used in discourse regarding [the designation context](#)

subject field

Definition: field of specific knowledge
Source: [ISO 1087-1 \(English\)](#) (3.1.2) ['subject field']

representation is in subject field

Definition: the [representation](#) is recognized and used in discourse regarding the [subject field](#)

12.2 Designations

12.2.1 Designation

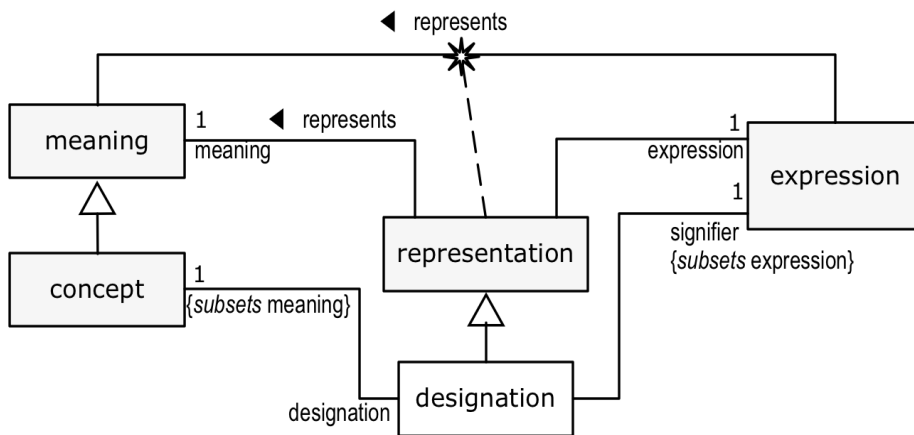

Figure 12.4 - Designation

This diagram shows the SBVR terminological entries of this sub clause as explained in Annex C.

designation

Source: [ISO 1087-1 \(English\)](#) (3.4.1) ['designation']
Definition: [representation of a concept](#) by a sign which denotes it
Note: In common usage, the signifier of a designation is used to refer to the instances of the designated concept. The designation, as defined here and in ISO 1087-1, does not refer to those instances directly, but relates the signifier to the concept. See 'concept has instance' in 8.5.3.
Necessity: Each [designation represents a concept](#).
Reference Scheme: the [signifier of the designation](#) and a [namespace that includes the designation](#)
Reference Scheme: A [verb concept wording that demonstrates the designation](#)
Reference Scheme: the [signifier of the designation](#) and the [concept that is represented by the designation](#)

concept has designation

Definition: the [designation represents the concept](#)

signifier

- Definition: [expression](#) that is a linguistic unit or pattern, such as a succession of speech sounds, written symbols or gestures, used in [a designation of a concept](#)
- Concept Type: [role](#)
- Example: the sequence of characters “car” used in a [designation](#) of the [concept](#) ‘automobile’ or used in a [designation](#) of the [concept](#) ‘railroad car’
- Example: the sequence of speech sounds (t), (r), and (ē) used in a [designation](#) of the [concept](#) ‘tree’
- Example: The graphic “€” used in a [designation](#) of the [concept](#) ‘Euro’

designation has signifier

- Definition: [the signifier is the expression of the designation](#)

12.2.2 Verbal and Nonverbal Designations

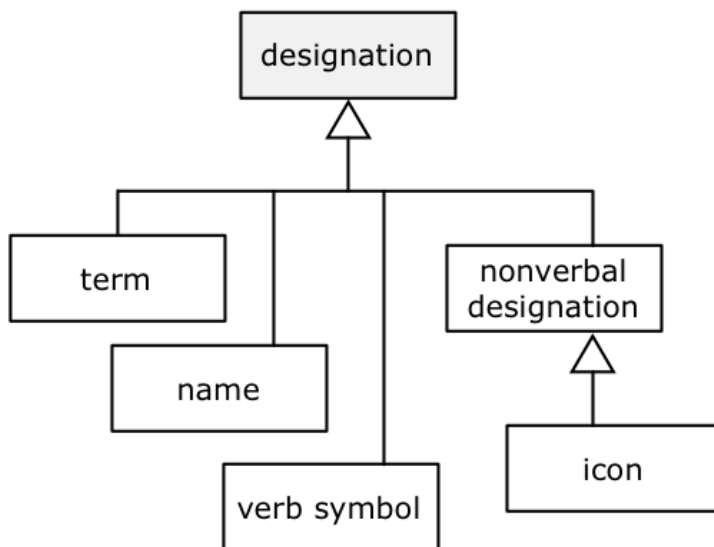

Figure 12.5 - Verbal and Nonverbal Designations

This diagram shows the SBVR terminological entries of this sub clause as explained in Annex C.

term

- Source: [ISO 1087-1 \(English\)](#) (3.4.3) ['term']
- Definition: verbal [designation of a general concept that is in a given subject field](#)
- General Concept: [designation](#)
- Note: A term is typically formed using a common noun or noun phrase.
- Example: EU-Rent agrees the word ‘car’ denotes its shared understanding of ‘rental-car-ness’ within <rental context>.

- Example: EU-Rent agrees the word ‘vehicle’ denotes its shared understanding of ‘car-ness’ within <rental context>.
- Example: EU-Rent agrees the word ‘customer’ denotes its shared understanding of ‘rental-customer-ness’ within <rental context>.
- Example: EU-Rent agrees the word ‘customer’ denotes its shared understanding of ‘car-purchaser-ness’ within <car-sales context> -- i.e., when EU-Rent disposes of cars after they reach their mileage or age threshold.
- Example: EU-Rent agrees the word ‘renter’ denotes its shared understanding of ‘rental-customer-ness’. (within any context).

name

- Source: [ISO 1087-1 \(English\)](#) (3.4.2) [‘appellation’]
- Definition: verbal [designation of an individual noun concept](#)
- General Concept: [designation](#)
- Necessity: **No name is a term.**
- Note: The expression of a name is typically a proper noun.

verb symbol

- Definition: [designation that represents a verb concept and that is demonstrated by a verb concept wording](#)
- Reference Scheme: [a verb concept wording that incorporates the verb symbol](#)
- Example: In the expression, ‘Each customer rents a car’, ‘rents’ is a [verb symbol](#) denoting a [verb concept](#).
- Example: In the expression, ‘A driver of a car returns the car to a branch office’, ‘of’ is a [verb symbol](#) for one verb concept (relating a driver to a car) and ‘returns to’ is another [verb symbol](#) denoting a [verb concept](#) (relating a driver to a car and a branch office).

nonverbal designation

- Definition: [designation that is not expressed as words of a language](#)
- Necessity: **No nonverbal designation is a term.**
- Necessity: **No nonverbal designation is a name.**
- Note: A verbal designation, such as a term or name, can contain parts that are nonverbal. Some abbreviations are nonverbal while others, being expressed as words, are terms or names.

icon

- Definition: [nonverbal designation](#) whose [signifier](#) is a picture
- Dictionary Basis: a usu. pictorial representation [[MWCD ‘icon’](#)]

- Example:  as a designation for the concept ‘u-turn’

12.2.3 Designation Preferences

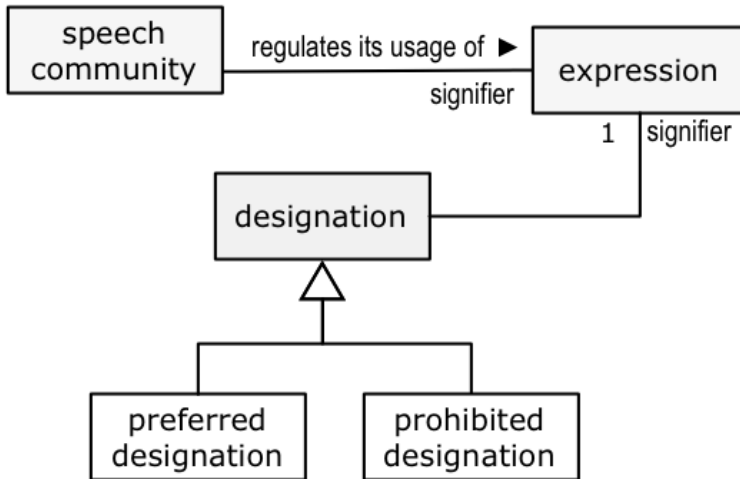

Figure 12.6 - Designation Preferences

This diagram shows the SBVR terminological entries of this sub clause as explained in Annex C.

speech community regulates its usage of signifier

preferred designation

Definition: **designation** that is selected by its owning **speech community** for a **given concept** from among alternative **designations** for **that concept** as being most desirable or productive

Example: EU-Rent's preferred designations for indicating the USA Dollar, Canadian Dollar, and Mexican Peso are, respectively, "USD", "CAD", and "MXN" (ISO 4217 currency codes).

prohibited designation

Definition: **designation** that is declared unacceptable by its owning **speech community**

Example: In EU-Rent, use of the dollar sign (\$) by itself is prohibited, to avoid confusion between the USA Dollar, Canadian Dollar, and Mexican Peso.

Note: What is prohibited is the use of a given expression to represent a given meaning. The same expression may be permitted, even preferred, to represent another meaning.

Necessity: **No preferred designation is a prohibited designation.**

12.2.4 Placeholder and Verb Concept Role Designation

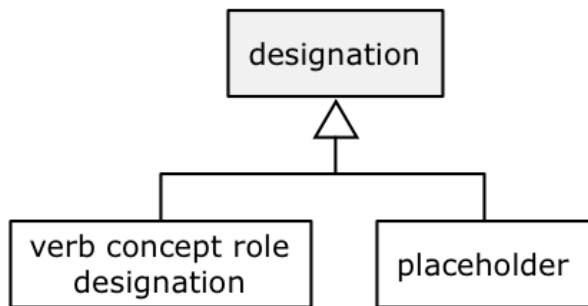

Figure 12.7 - Placeholder and Verb Concept Role Designation

This diagram shows the SBVR terminological entries of this sub clause as explained in Annex C.

verb concept role designation

- Definition: designation that is of a verb concept role and that is recognizable in use in the context of another role of the same verb concept
- Necessity: No verb concept role designation is a term.
- Necessity: No verb concept role designation is a placeholder.
- Necessity: No verb concept role designation represents a situational role.
- Note: A verb concept role designation should not be confused with a placeholder or with a term for a situational role, even though all of these can have the same expression. A situational role is a general concept and is not a verb concept role.
- Note: A verb concept role designation should not be confused with a placeholder, which is part of a verb concept wording. In uses of a verb concept wording, placeholders are replaced. A verb concept role designation can replace a placeholder. Verb concept role designations occur in statements and definitions to refer to what fills the role.
- Example: The verb concept role designation, ‘CEO’, for a role in the verb concept ‘corporation has CEO’ does not represent a situational role and is not the same thing as the ‘CEO’ placeholder in that verb concept wording. Here we see different designations have the same signifier, ‘CEO’. The verb concept role designation represents the verb concept role in the context of using the verb concept, such as in the phrases ‘EU-Rent’s CEO’ and ‘the CEO of some corporation’. But a situational role, even if defined in terms of the verb concept can be used independently, as in the statement, ‘Every CEO is a person’. The placeholder ‘CEO’ of the verb concept wording ‘corporation has CEO’ is part of the form and gets replaced in each use of the form. In the statement, ‘EU-Rent has exactly one CEO’, the ‘CEO’ placeholder of the verb concept wording ‘corporation has CEO’ is replaced by ‘exactly one CEO’, comprised of a quantifier and the verb concept role designation ‘CEO’, which is understood to represent the verb concept role because of its context: it is used in relation to a corporation.
- Note: Sub clause 23.7.4 shows an example of a verb concept role designation, ‘prior example’, and shows examples of verb concept roles having no verb concept role designation.

placeholder

- Definition: designation of a verb concept role within a verb concept wording marking a place where, in uses of the verb concept wording, an expression denotes what fills the verb concept role
- Necessity: Each placeholder *is in* exactly one verb concept wording.
- Necessity: Each placeholder *represents* exactly one verb concept role.
- Necessity: Each placeholder of each verb concept wording of a verb concept *represents* a verb concept role of the verb concept.
- Necessity: Each placeholder *has* at most one starting character position.
- Necessity: Each placeholder of a verb concept wording that has a text *has* a starting character position.
- Reference Scheme: the verb concept wording that has the placeholder and the expression of the placeholder and the starting character position of the placeholder
- Note: The expression of a placeholder often consists of the signifier of a designation used by the placeholder, but it can include other things such as delimiting characters (as in ‘[proposition] is true’) or a subscript (as in ‘proposition1 is true’) by which the placeholder can be distinguished within the verb concept wording that has it. A placeholder need not use a designation (as in ‘... is true’).

12.3 Wordings for Verb Concepts

12.3.1 Verb Concept Wording

The concepts defined in this sub clause are intended to provide a means of representing syntactic elements of a language that are used to represent verb concepts in statements and definitions. The elements defined here are intentionally minimal and may or may not be adequate for specific languages.

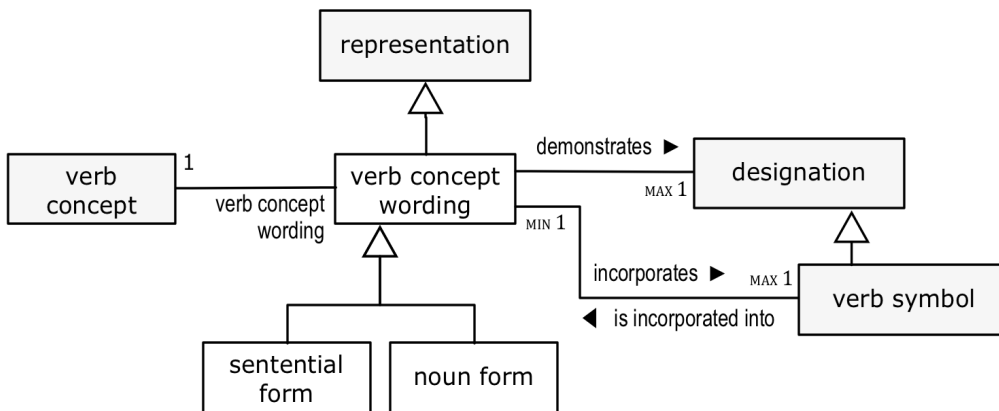

Figure 12.8 - Verb Concept Wording

This diagram shows the SBVR terminological entries of this sub clause as explained in Annex C.

verb concept wording

- Definition: [representation of a verb concept](#) by [an expression that](#) has a syntactic structure involving [a signifier for the verb concept](#) and [signifiers](#) for its [verb concept roles](#)
- Note: The verb concept wording relates to a signifier for the verb concept by '[verb concept wording incorporates verb symbol](#)'. The verb concept wording relates to signifiers for the verb concept roles by '[verb concept wording has placeholder](#)'.
- Note: A verb concept wording is not a designation for a verb concept. It is a syntactic structure of expressions that is a pattern for using a designation of the verb concept in definitions and statements.
- Necessity: [Each verb concept wording represents exactly one verb concept.](#)
- Necessity: [Each verb concept wording has at least one placeholder.](#)
- Necessity: [At most one role of a verb concept that has a verb concept wording is not represented by a placeholder of the verb concept wording.](#)
- Necessity: [No verb concept wording is a designation.](#)
- Necessity: [Each verb concept wording demonstrates at most one designation.](#)
- Necessity: [If a designation is demonstrated by a verb concept wording of a verb concept then the verb concept has the designation.](#)
- Example: The [verb concept wording](#) 'customer rents car' incorporates the [verb symbol](#) 'rents' and has two placeholders. One [placeholder](#) uses the [designation](#) 'customer' and is at the [starting character position](#) 1. The other [placeholder](#) uses the [designation](#) 'car' and is at the [starting character position](#) 16.
- Example: The [verb concept wording](#) 'driver of car' demonstrates the [verb symbol](#) 'of' and has two placeholders, one using the [designation](#) 'driver' at the [starting character position](#) 1, and the other using the [designation](#) 'car' at the [starting character position](#) 11.
- Example: The [verb concept wording](#) 'country charges tax rate on date' incorporates the [verb symbol](#) 'charges on' that represents the same [verb concept](#) as the [verb concept wording](#).

- Note: Recognizing how a statement such as, “A customer must rent at most one car”, fits the pattern or template of a verb concept wording, such as ‘customer rents car’, is part of the process of language parsing and interpretation and is not covered by this specification.
- Note: In some languages, verb concept wordings occur that involve only a positioning of placeholders with no other designation — no verb or preposition.
- Reference Scheme: the expression of the verb concept wording and a namespace that includes the verb concept wording

verb concept has verb concept wording

- Definition: the expression of the verb concept wording represents the verb concept as a grammatical structure of expressions in some language
- Definition: the verb concept wording represents the verb concept

verb concept wording incorporates verb symbol

- Definition: the verb concept wording shows a pattern of using the expression of the verb symbol plus expressions of the placeholders for each of the roles of the verb concept that has the verb concept wording
- Synonymous Form: verb symbol is incorporated into verb concept wording
- Synonymous Form: verb concept wording demonstrates designation
- Necessity: Each verb concept wording incorporates at most one verb symbol.
- Necessity: Each verb symbol is incorporated into at least one verb concept wording.
- Note: If a verb concept wording demonstrates a designation, the signifier of that designation is what is seen in the expression of the verb concept wording when placeholder expressions have been removed.

12.3.2 Kinds of Verb Concept Wording

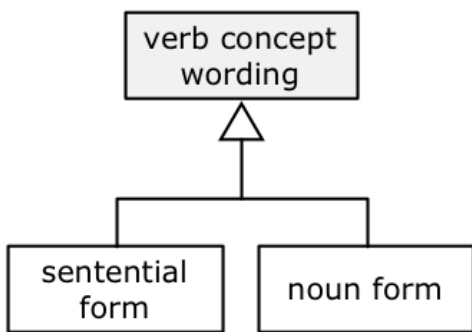

Figure 12.9 - Kinds of Verb Concept Wording

This diagram shows the SBVR terminological entries of this sub clause as explained in Annex C.

sentential form

- Definition: verb concept wording that is a pattern or template that can be used for stating a proposition based on a verb concept
- Example: ‘car is used in rental agreement’ is a sentential form of a binary verb concept.
- Example: ‘car is unavailable’ is a sentential form of a characteristic.
- Example: Assuming there is a role ‘renter’ ranging over the concept ‘customer’, the following can all be alternative sentential forms of the same verb concept:
car has renter
customer rents car
car is rented by customer
renter rents car
- Necessity: Each role of the verb concept that has a sentential form is represented by a placeholder of the sentential form.

noun form

- Definition: verb concept wording that acts as a noun rather than forming a proposition
- Note: A noun form can have a placeholder for each role of a verb concept, in which case the noun form result comes from the role the first placeholder is for. A noun form can also have one less placeholder than there are roles, in which case the noun form result comes from the role that no placeholder is for.
- Example: ‘transferred car of car transfer’ for the verb concept ‘car transfer has transferred car’. This form yields a transferred car.
- Example: ‘| number |’ for the verb concept ‘number has absolute value’. The form yields the absolute value of the number.
- Example: ‘number₁ + number₂’ for the verb concept ‘number₁ + number₂ = number₃’. This form yields the third number (the sum of adding the first two numbers).
- Example: ‘transferring rental car’ for the verb concept ‘car transfer has transferred car’. This form yields the car transfer, which is an action. Gerunds are used in noun forms like this for actions, events, and states. They are used in sentences like this: “A rental car must be cleaned before transferring the rental car.”
- Example: ‘late shipment’ for the unary verb concept ‘shipment is late’. This form yields a shipment having the characteristic of being late.

12.4 Placeholders in Verb Concept Wordings

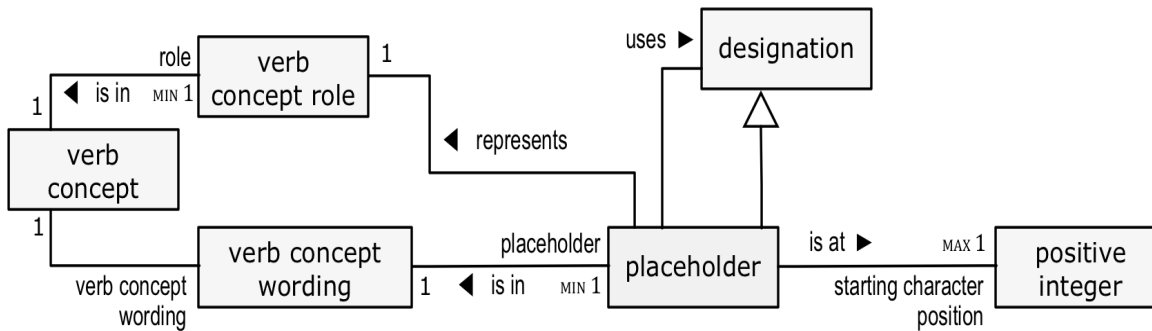

Figure 12.10 - Placeholders in Verb Concept Wordings

This diagram shows the SBVR terminological entries of this sub clause as explained in Annex C.

verb concept wording has placeholder

Definition: **the placeholder** indicates a place for expression of what fills a **role** in **the verb concept wording**

Synonymous Form: **placeholder is in verb concept wording**

starting character position

Definition: **positive integer** that is an ordinal position where a **text** starts within an encompassing **text**

Concept Type: **role**

placeholder is at starting character position

Definition: **the expression of the placeholder** is textual and occurs within a textual **expression of a verb concept wording** starting at **the starting character position**

Synonymous Form: **placeholder has starting character position**

Note: If a placeholder is at a starting position within a verb concept wording, then the expression of the placeholder exactly matches the characters in the expression of the verb concept wording, character for character, from the starting character position through the full length of the placeholder's expression. Placeholders' expressions do not overlap each other within the expression of a verb concept wording. If the verb concept wording demonstrates a designation, the designation's signifier appears within the part or parts of the verb concept wording's expression that are not occupied by placeholders.

Note: See 23.7.4 for detailed examples showing various aspects of verb concept wordings, placeholders, and their starting character positions.

placeholder uses designation

Definition: **the expression of the placeholder** incorporates **the signifier of the designation** thereby indicating that **that verb concept role represented by the placeholder ranges over the concept represented by the designation**

- Note: The means by which a placeholder incorporates a designation depends on convention. SBVR does not require a particular convention, but it uses one described in Annex A, SBVR Structured English.
- Example: The ‘proposition’ placeholder in the verb concept wording ‘proposition is true’ uses the designation ‘proposition’. The statement, “A fact is true,” is understood to use that verb concept wording because a fact is a proposition, but “A line is true” is not recognized as using that verb concept wording because a line is not a proposition.
- Example: Consider two verb concept wordings for the same verb concept: ‘rental is returned on date’ and ‘rental has return date’. The second placeholders of the two forms represent the same role, but they use different designations (‘date’ and ‘return date’). If “Rental 876” denotes a rental, then the statement, “Rental 876 is returned on 30 June 2006,” is understood to use the first verb concept wording because “30 June 2006” is understood to denote a date, but the statement, “Rental 879 has 30 June 2006,” is not understood to use the second verb concept wording because “30 June 2006” is not understood to denote a return date (only a date). “Rental 879 has the return date 30 June 2006” uses the second verb concept wording.
- Example: In the verb concept wording ‘rental car₁ replaces rental car₂’, both placeholders (‘rental car₁’ and ‘rental car₂’) use the same designation, ‘rental car’.

12.5 Statements

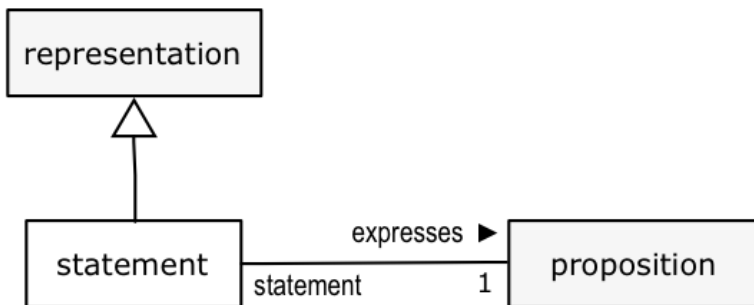

Figure 12.11 - Statement

This diagram shows the SBVR terminological entries of this sub clause as explained in Annex C.

statement

- Definition: representation of a proposition by an expression that is non-paradoxical and meaningful and that is a simple sentence with one declarative clause, or a complex sentence or group of sentences that together contain one or more declarative clauses
- Necessity: Each statement expresses exactly one proposition.
- Reference Scheme: the expression of the statement and a closed logical formulation that formalizes the statement
- Note: A statement combines a single expression with a single meaning of that expression. If an expression is an ambiguous sentence, one that represents two different propositions, each of

the two representations is considered to be a separate statement. See '[expression is unambiguous to speech community](#)' in 12.1.2.

- Note: A paradoxical expression is not an expression of a statement. A paradox is independent of whether or not the truth-value is known.
- Note: In sentences each declarative clause represents individually a given proposition that is its meaning. Complex sentences and groups of multiple sentences can also represent a single proposition. The terms "sentence" and "clause" are used in SBVR with their most common grammatical meaning
- Note: Including a statement of a proposition in a descriptive example does not assert the truth of the proposition. It is simply an illustrative example of the concept. This is unlike including a statement of the same proposition in a factbase which, by definition, includes an assertion of "taken to be true."
- Necessity: **Each [statement](#) that *represents* a given [proposition](#) and each [closed logical formulation](#) that *means* that given [proposition](#) must** be synonymous, and both individually and together with all the others determine **the [proposition](#)** i.e., **the [meaning](#)**.
- Note: How the meaning of a statement is determined depends on the natural language in which it is expressed. SBVR defines how to determine the meaning of a closed logical formulation.

statement expresses proposition

- Definition: **the [statement](#) *represents* the [proposition](#)**
- Synonymous Form: **[proposition](#) *has* [statement](#)**

13 Concept Definition

13.1 Definitions

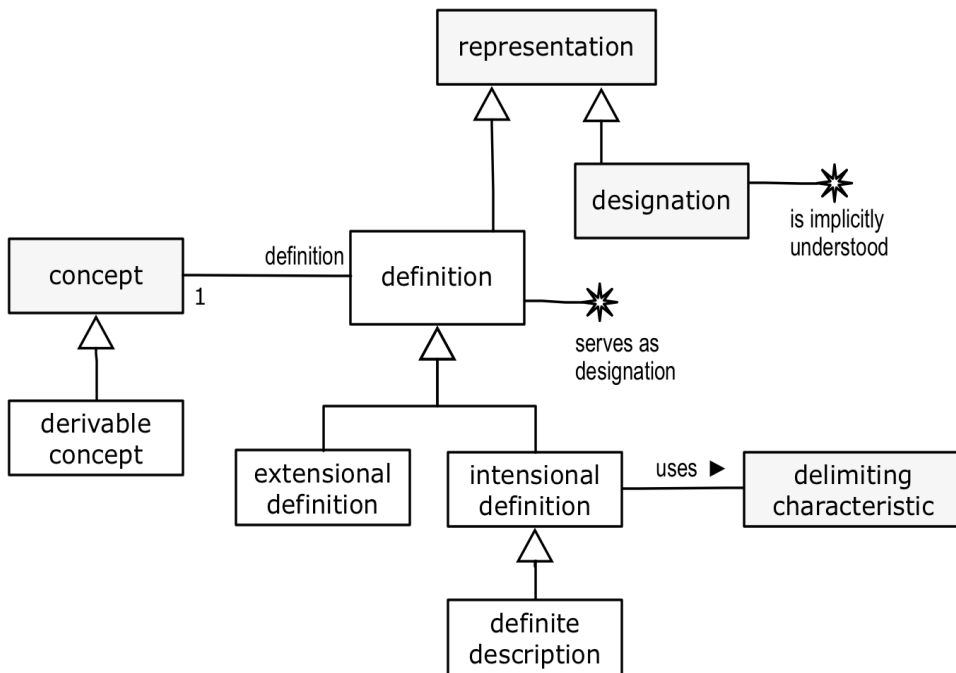

Figure 13.1 - Definition

definition

- Source: [ISO 1087-1 \(English\)](#) (3.3.1) [‘definition’]
- Definition: [representation of a concept](#) by a descriptive statement [[expression](#)] which serves to differentiate it from related [concepts](#)
- Definition: [representation](#) (as through a word or phrase) expressing the essential nature of a person or thing or class of persons or of things : an answer to the question “what is x?” or “what is an x?”
- Necessity: [Each definition represents a concept.](#)
- Reference Scheme: [the expression of the definition and a closed projection that formalizes the definition](#)
- Note: ‘[definition](#)’ is used in SBVR in the sense of the formal term “definiens.”

concept has definition

- Definition: [the definition represents the concept](#)

intensional definition

Source: [ISO 1087-1 \(English\)](#) (3.3.2) ['intensional definition']
Definition: [definition](#) which describes the intension of a [concept](#) by stating the superordinate [concept](#) and the [delimiting characteristics](#)
General Concept: [definition](#)
Necessity: No [intensional definition](#) is an [extensional definition](#).

intensional definition uses delimiting characteristic

Definition: the [delimiting characteristic](#) serves to distinguish the [concept](#) defined by the [intensional definition](#) from other [concepts](#)

definite description

Definition: [intensional definition](#) of an individual
Example: the car movement that has the movement id "UK-12345-abc-xyz"
Necessity: Each [definition of an individual noun concept](#) is a [definite description](#).
Necessity: Each [definite description](#) is the [definition of an individual noun concept](#).
Necessity: Each [definite description](#) uses a [reference scheme](#) for the individual.

extensional definition

Source: [ISO 1087-1 \(English\)](#) (3.3.3) ['extensional definition']
Definition: description of a concept by enumerating all of its subordinate concepts under one criterion of subdivision
General Concept: [definition](#)
Necessity: No [extensional definition](#) is an [intensional definition](#).

definition serves as designation

Definition: the [definition](#) acts as a [designation of the concept](#) defined by the [definition](#)
Note: In the case of a concept for which no designation is given, the concept is represented by its definition.

derivable concept

Definition: [concept](#) whose [extension](#) can be determined from its [definition](#) or from [rules](#)

designation is implicitly understood

Definition: the [designation](#) is generally understood by its owning [community](#) without an explicit [definition](#) for the [concept](#) it designates

13.2 Definitional Entries

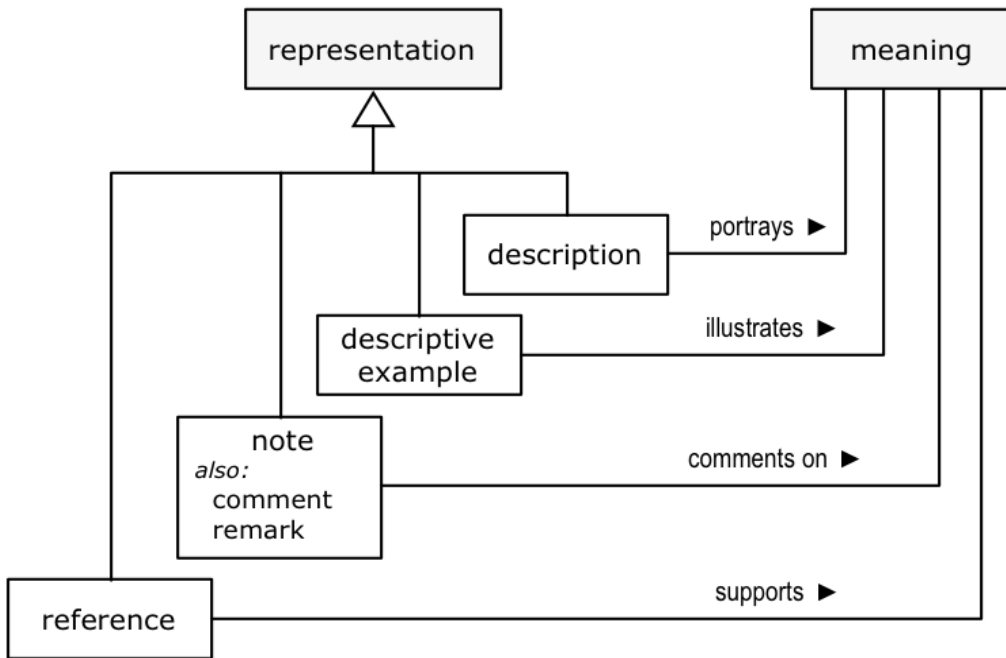

Figure 13.2 - The Description, Example, Note, and Reference Elements of a Definition

description

- Definition: [representation](#) that provides a detailed account of something, a verbal portrait
- Dictionary Basis: a spoken or written representation or account of a person, object, or event [NODE 'description']
- Necessity: No [description](#) that [portrays](#) a [concept](#) is a [descriptive example](#) that [illustrates](#) that [concept](#).
- Necessity: No [description](#) that [portrays](#) a [concept](#) is a [note](#) that [comments on](#) that [concept](#).
- Necessity: No [description](#) that [portrays](#) a [concept](#) is a [reference](#) that [supports](#) that [concept](#).

description portrays meaning

- Note: The meaning of a description that portrays a concept is most likely not that concept. A description can be a statement, in which case, its meaning is a proposition.

descriptive example

- Definition: [representation](#) that provides descriptive material that is a sample of the thing defined
- Source: based on MWCD and NODE
- Dictionary Basis: one (as an item or incident) that is representative of all of a group or type [MWCD 'example']
- Dictionary Basis: a thing characteristic of its kind or illustrating a general rule [NODE 'example']
- Necessity: No [descriptive example](#) that [illustrates](#) a [concept](#) is a [definition of](#) that [concept](#).
- Necessity: No [descriptive example](#) that [illustrates](#) a [concept](#) is a [description](#) that [portrays](#) that [concept](#).

Necessity: [No descriptive example that illustrates a concept is a note that comments on that concept.](#)

Necessity: [No descriptive example that illustrates a concept is a reference that supports that concept.](#)

Example: Chris Cushing is an example of EU-Rent's concept of 'rental customer'.

Example: The vehicle with VIN#88744332 is an example of EU-Rent's concept of 'rental car'.

[descriptive example illustrates meaning](#)

Note: The meaning of a descriptive example is typically a proposition.

[note](#)

Definition: [representation that](#) annotates or explains

Necessity: [No note that comments on a concept is a definition of that concept.](#)

Necessity: [No note that comments on a concept is a description that portrays that concept.](#)

Necessity: [No note that comments on a concept is a descriptive example that illustrates that concept.](#)

Necessity: [No note that comments on a concept is a reference that supports that concept.](#)

Synonym: [remark](#)

Synonym: [comment](#)

[note comments on meaning](#)

Note: The meaning of a note that comments on a concept is most likely not that concept. A note is typically a statement whose meaning is a proposition.

[comment](#)

See: [note](#)

[remark](#)

See: [note](#)

[reference](#)

Definition: [representation that](#) is the mention or citation of a source of information used to direct a reader elsewhere for additional information about [a given concept](#)

Dictionary Basis: a mention or citation of a source of information in a book or article [NODE 'reference']

Necessity: [No reference that supports a concept is a definition of that concept.](#)

Necessity: [No reference that supports a concept is a description that portrays that concept.](#)

Necessity: [No reference that supports a concept is a descriptive example that illustrates that concept.](#)

Necessity: [No reference that supports a concept is a note that comments on that concept.](#)

Example: 'The Highway Code' published by HMSO, 2005.

Example: The descriptions of car models' capacity, fuel economy, and performance taken from the manufacturers' specifications.

[reference supports meaning](#)

14 Structures in Concept Systems

14.1 Structural Connections between Things

14.1.1 Associations

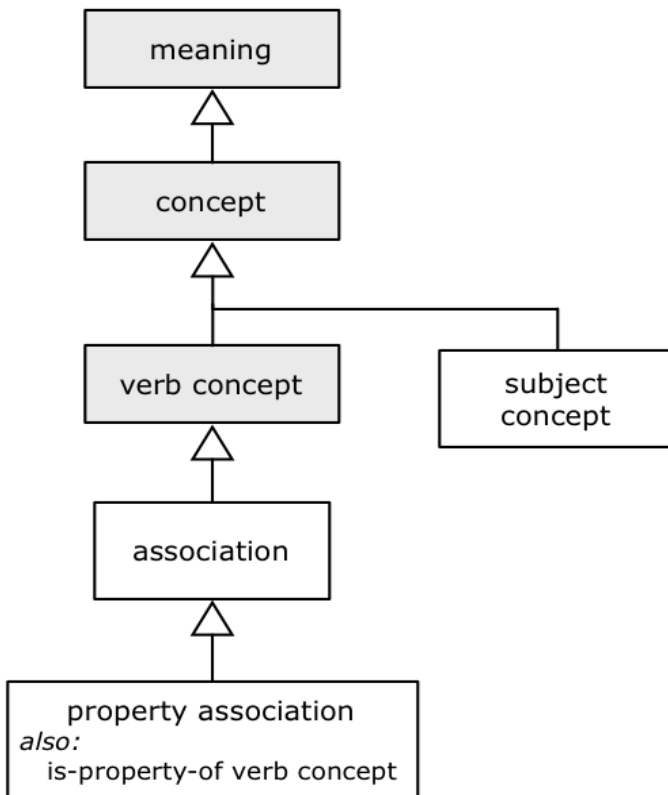

Figure 14.1 - Association and Kinds of Association

association

- Definition: verb concept that *has more than one role and that* has a nonhierarchical subject-oriented connection drawn from experience, based on practical rather than theoretical considerations
- Source: based on ISO 1087-1 (English) (3.2.23) ['associative relation', 'pragmatic relation']
- Dictionary Basis: to join (things) together or connect (one thing) with another [MWU verb (3) 'associate']
- Example: The verb concept 'additional driver is authorized in rental'
- Example: The verb concept 'car manufacturer supplies car model'
- Example: The verb concept 'car manufacturer delivers consignment to branch'

property association

- Definition: [association](#) that is defined with respect to a given [concept](#) such that each [instance of the association](#) is an [actuality that a given instance of the concept](#) has a particular [property](#)
- Necessity: Each [instance of each property association](#) is an [actuality that a thing](#) has a particular [property](#).
- Dictionary Basis: a quality or trait belonging to a person or thing; [MWUD 'property']
- Synonym: [is-property-of verb concept](#)
- Example: The association '[engine size](#) of [car model](#)'
- Example: The association '[person](#) has [eye color](#)'

is-property-of verb concept

- See: [property association](#)

subject concept

- Definition: [concept](#) that provides a context for recognizing [designations](#) used to attribute [properties](#) to [instances of the concept](#)
- Concept Type: [role](#)
- Example: In the phrase, "each rental's drop-off date," the concept 'rental' is a subject concept with respect to recognizing the designation 'drop-off date' representing a role in a verb concept that relates a rental to its drop-off date.
- Example: In the phrase, "an assigned rental," the concept 'rental' is a subject concept with respect to recognizing the designation 'assigned' representing a characteristic attributable to rentals ('rental is assigned').

14.1.2 Partitive Connections

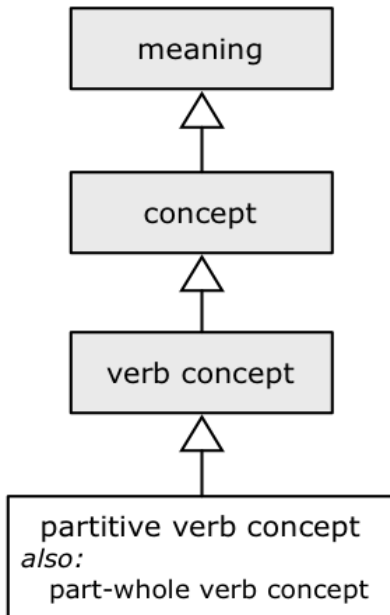

Figure 14.2 - Partitive Verb Concept

partitive verb concept

Definition:	<u>verb concept</u> where each instance is an actuality that a given part is in the composition of a given whole
Source:	based on <u>ISO 1087-1 (English)</u> (3.2.22) [‘partitive relation’]
Dictionary Basis:	to place, list, or rate as a part or component of a whole or of a larger group, class, or aggregate [MWU (2a) ‘include’]
Necessity:	Each <u>partitive verb concept is a binary verb concept</u> .
Necessity:	Each instance of each partitive verb concept is an actuality that a given part is in the composition of a given whole.
Example:	The verb concept ‘ <u>country</u> is included in <u>region</u> ’ An example of an instance of that verb concept is that Sweden is included in Scandinavia.
Example:	The verb concept ‘ <u>branch</u> is included in <u>local area</u> ’
Example:	The verb concept ‘ <u>car model</u> is included in <u>car group</u> ’
Example:	To reflect the composition of a mechanical pencil, the verb concepts: ‘ <u>barrel</u> is included in <u>mechanical pencil</u> ’, ‘ <u>lead-advance mechanism</u> is included in <u>mechanical pencil</u> ’, ‘ <u>lead (refill)</u> is included in <u>mechanical pencil</u> ’, and ‘ <u>refill eraser</u> is included in <u>mechanical pencil</u> ’ [an example in ISO704]
Synonym:	<u>part-whole verb concept</u>
Note:	For more discussion and examples see: Annex B.3.4, C.7, as well as the EU-Rent examples in Annex G.

part-whole verb concept

See: [partitive verb concept](#)

14.2 Structural Connection between Concepts

14.2.1 Categorization

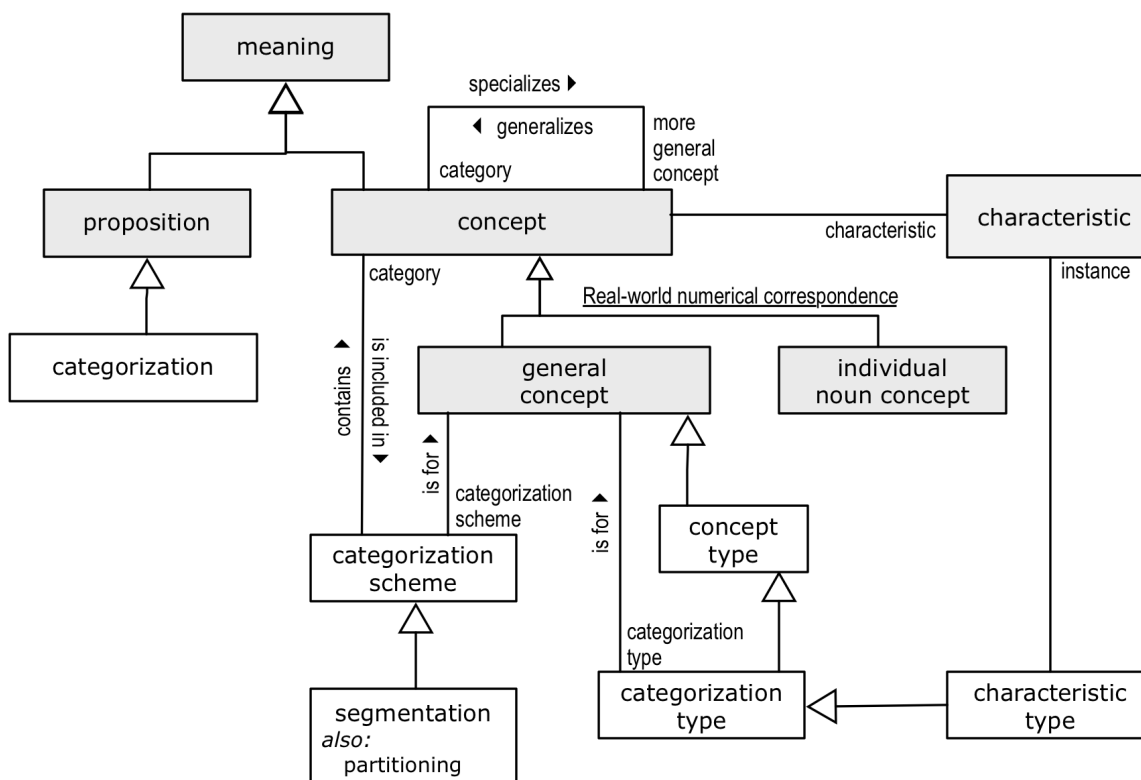

Figure 14.3 - Categorization

categorization

Definition: [proposition](#) that a given [general concept](#) specializes a given [general concept](#)

Dictionary Basis: the state of being categorized [MWU]

Example: The general concept ‘[high-end customer](#)’ specializes the general concept ‘[customer](#).’

Example: The general concept ‘[points rental](#)’ specializes the general concept ‘[rental](#).’

Example: The general concept ‘[airport branch](#)’ specializes the general concept ‘[branch](#).’

Note: For more discussion and examples see: Annex B.2.1, I.2, C.5, C.6, as well as the EU-Rent examples in Annex G.

categorization scheme

- Definition: scheme for allocating [things](#) in [the extension of a given general concept](#) into [the extensions of categories of that general concept](#)
- Example: The [general concept](#) 'person' categorized by age range and gender into categories 'boy', 'girl', 'man', 'woman'.
- Dictionary Basis: an orderly combination of related parts [AH (3) 'scheme']

categorization scheme is for general concept

- Definition: [the general concept](#) is divided into [category\(s\)](#) by [the categorization scheme](#)
- Necessity: [Each categorization scheme is for at least one general concept.](#)
- Synonymous Form: [general concept has categorization scheme](#)

categorization scheme contains category

- Definition: [the category](#) is included in [the categorization scheme](#) as one of the categories into which the scheme divides things
- Synonymous Form: [category is included in categorization scheme](#)
- Concept Type: [partitive verb concept](#)
- Necessity: [Each category that is included in a categorization scheme that is for a general concept is a category of that general concept.](#)

segmentation

- Definition: [categorization scheme](#) whose contained [categories](#) are complete (total) and disjoint with respect to [the general concept that has the categorization scheme](#)
- Synonym: [partitioning](#)

partitioning

- See: [segmentation](#)

concept type

- Definition: [general concept](#) that [specializes the concept](#) 'concept'
- Note: A [concept](#) is related to a [concept type](#) by being an [instance](#) of the [concept type](#).
- Example: [verb concept](#), [role](#), [concept type](#)

categorization type

- Definition: [concept type](#) whose [instances](#) are always [categories of a given concept](#)
- Note: A [categorization type](#) is either partial or complete. It is complete if it necessarily categorizes everything of the general concept that it is for.
- Example: EU-Rent's categorization type for EU-Rent's concept of 'branch' whose instances are categories of branch: 'airport branch', 'agency', and 'city branch'.

categorization type is for general concept

- Synonymous Form: [general concept has categorization type](#)

characteristic type

- Source: [ISO 1087-1 \(English\)](#) (3.2.5) ['type of characteristics']
- Definition: category of [the concept] '[characteristic](#)' which serves as a criterion of subdivision when establishing concept systems

General Concept: [categorization type](#)
 Necessity: [Each instance of each characteristic type is a characteristic.](#)
 Example: The extension of the [characteristic type](#) ‘color’ includes the characteristics ‘[thing is blue](#)’, ‘[thing is red](#)’, ‘[thing is green](#)’ etc.

Real-world Numerical Correspondence

Definition: [the categorization scheme of the concept ‘concept’ that classifies a concept](#) based on whether or not [the concept](#) always corresponds to one specific real-world individual
 Necessity: [The concept ‘individual noun concept’ is included in Real-world Numerical Correspondence.](#)
 Necessity: [The concept ‘general concept’ is included in Real-world Numerical Correspondence.](#)

14.2.2 Classification

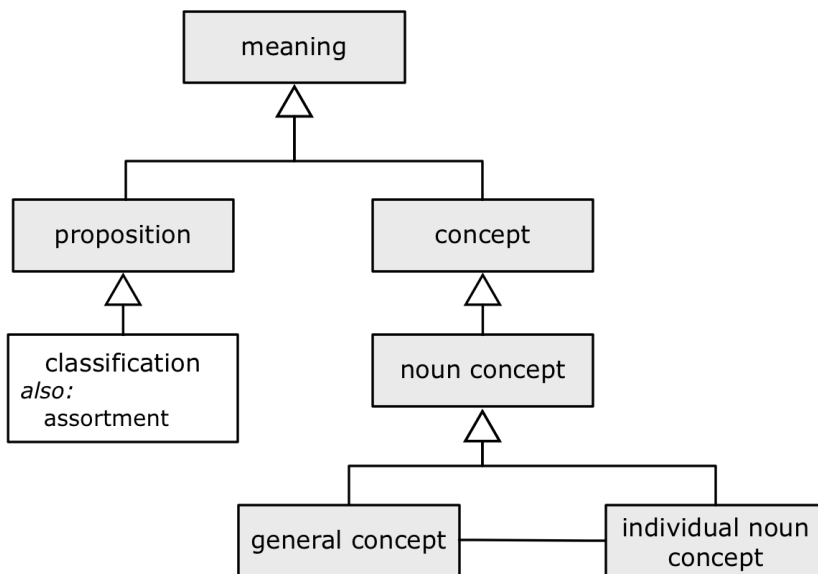

Figure 14.4 - Classification

classification

Definition: [proposition that the instance of a given individual noun concept is an instance of a given general concept](#)
 Dictionary Basis: to place in the same group with others : associate in a class [MWU (3) “assort”]
 Example: The individual noun concept ‘[Euro](#)’ specializes the general concept ‘[currency](#)’
 Example: The individual noun concept ‘[Ford Motor Company](#)’ specializes the general concept ‘[car manufacturer](#)’
 Example: The individual noun concept ‘[Switzerland](#)’ specializes the general concept ‘[country](#)’
 Synonym: [assortment](#)

Note: For more discussion and examples see: Annex B.3.5, as well as the EU-Rent examples in Annex G.

assortment

See: [classification](#)

14.2.3 Characterization

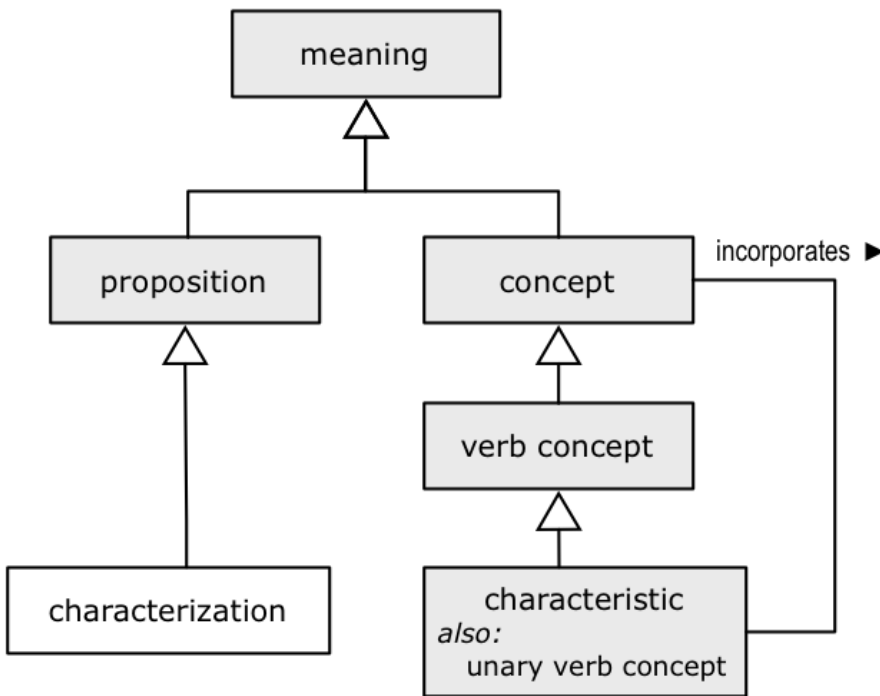

Figure 14.5 - Characterization

characterization

Definition: [proposition](#) that a given concept incorporates a given characteristic

Dictionary Basis: to describe the essential character or quality of [MWU (2) “characterize”]

Example: The proposition that the concept ‘[authorized driver](#)’ incorporates the characteristic ‘[person](#) is licensed’

Example: The proposition that the concept ‘[Eiffel Tower](#)’ incorporates the characteristic ‘[structure](#) is quadrilateral’

14.2.4 Verb Concept Objectifications

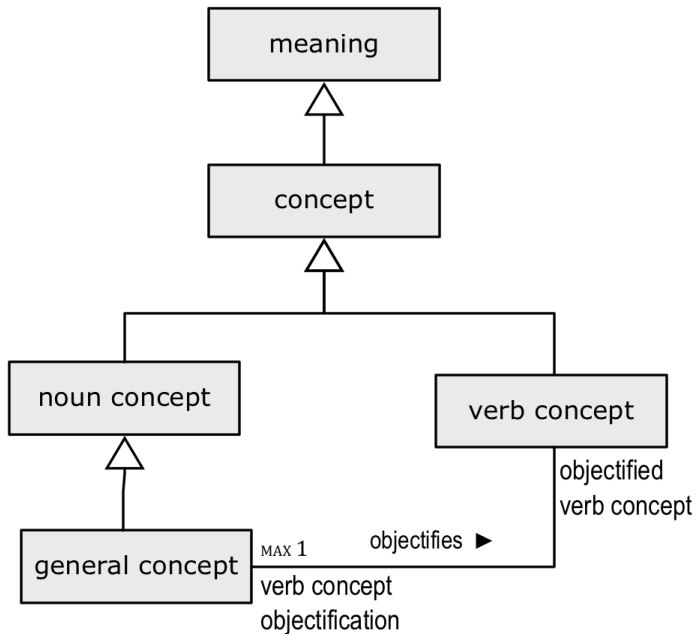

Figure 14.6 - Verb Concept Objectification

verb concept objectification

Definition: general concept that *objectifies* a given verb concept

Concept Type: role

objectified verb concept

Definition: verb concept that *is objectified by* a given general concept

Concept Type: role

general concept objectifies verb concept

Definition: the general concept *incorporates each characteristic that is incorporated by the verb concept and the general concept incorporates no characteristic that is not incorporated by the verb concept*

Synonymous Form: verb concept has verb concept objectification

Synonymous Form: general concept has objectified verb concept

Necessity: Each verb concept is objectified by at most one general concept.

Necessity: Each general concept that objectifies a verb concept is coextensive with the verb concept.

Example: The general concept ‘sponsorship’ objectifies the verb concept ‘company sponsors publication’. Each sponsorship is an actuality that a given company sponsors a given publication.

Note:

See Annex I.4.4 and Annex C.9 for additional discussion.

14.3 Contextualization

14.3.1 Context of Thing

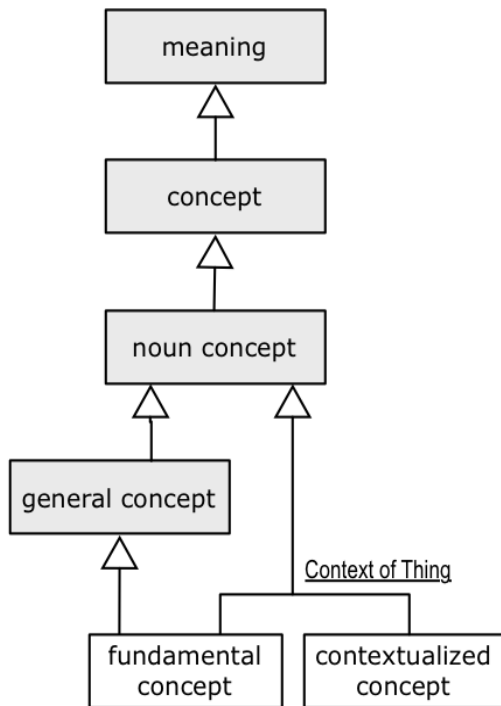

Figure 14.7 - Contextualization

fundamental concept

Definition:

[general concept](#) whose real-world individuals are perceived by [a given semantic community](#) as being in their essence, apart from any [situation](#) in which they are involved or [viewpoint](#) from which they are considered

Dictionary Basis:

a property or group of properties of something without which it would not exist or be what it is [NODE 'essence']

Concept Type:

[concept type](#)

Example:

car (as contrasted with 'rental car')

Example:

person (as contrasted with 'customer')

Note:

Each semantic community decides what is within its body of shared meanings. A concept that is considered as fundamental by one community may, to another community, be a role or facet or category of a more broadly-defined concept.

contextualized concept

Definition: [role or facet](#)
General Concept: [noun concept](#)

Context of Thing

Definition: [the segmentation of the concept 'noun concept' that classifies a noun concept based on whether the noun concept's real-world individuals are perceived by the semantic community as in their uninvolved essence or as to their involvement in a situation or from a viewpoint](#)

Necessity: [The concept 'fundamental concept' is included in Context of Thing.](#)
Necessity: [The concept 'contextualized concept' is included in Context of Thing.](#)

14.3.2 Situations

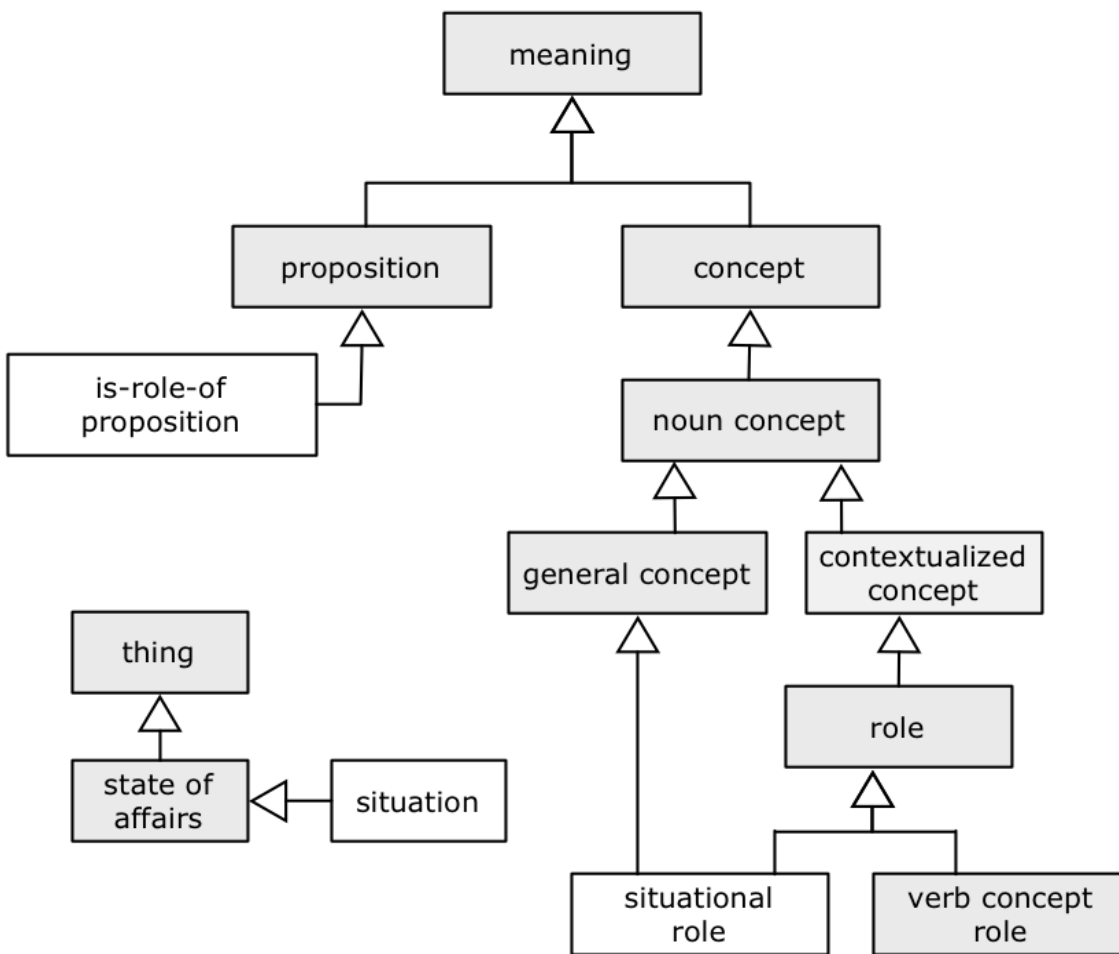

Figure 14.8 - Situations

situation

- Definition: [state of affairs](#) **that** is a set of circumstances that provides the context from which [roles](#) played may be understood or assessed
- Dictionary Basis: a set of circumstances in which one finds oneself; a state of affairs [NODE 'situation']
- Dictionary Basis: the circumstances that form the setting for an event, statement, or idea, and in terms of which it can be fully understood or assessed [NODE 'context']
- Note: A situation typically pertains for some period of time, during which changes may occur.
- Example: The situation 'breakdown during rental' is the set of circumstances that starts with the breakdown of a car while on rental and continues until the broken-down car, having been replaced by another car, has been returned to a EU-Rent location.

is-role-of proposition

- Definition: [proposition](#) **that a given** [role](#) **ranges over a given** [general concept](#) **in some** [situation](#)
- Example: The role '[replacement car](#)' in the situation of a breakdown during a rental ranges over the general concept '[rental car](#)'
- Example: The role '[pick-up branch](#)' in the situation of a rental ranges over the general concept '[branch](#)'
- Note: For more discussion and examples see: Annex B.3.2, C.5, as well as the EU-Rent examples in Annex G.

situational role

- Definition: [general concept](#) **that corresponds to** [things](#) being in **some** [situation](#), such as playing a part, assuming a function, or being used in some circumstances
- General Concept: [general concept](#)
- General Concept: [role](#)
- Concept Type: [concept type](#)

14.3.3 Facets

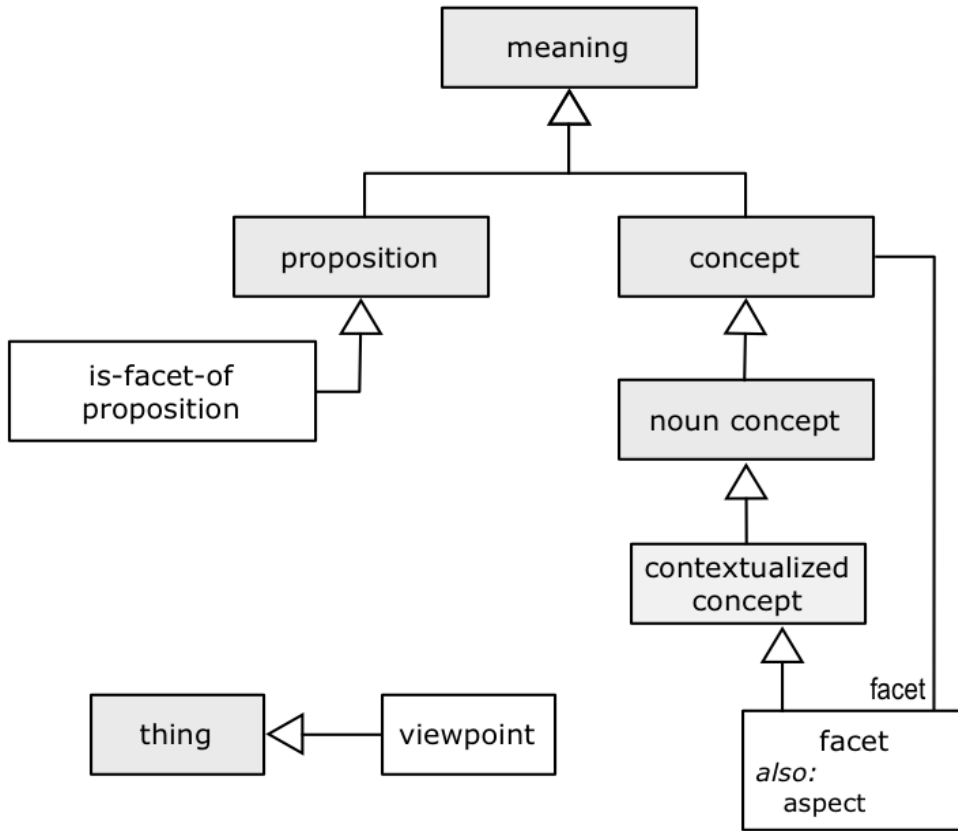

Figure 14.9 - Facets

is-facet-of proposition

Definition:

proposition that a given concept has a given facet

Example:

The concept 'rental car' has the facet 'asset' from the viewpoint of financial accounting.

Example:

The concept 'person' has the facet 'driver' from the viewpoint of car rental.

Note:

A given community may choose to include any number of facets, including just one or none at all.

Note:

For more discussion and examples see: Annex B.3.3, as well as the EU-Rent examples in Annex G.

facet

Definition:

concept that *generalizes* a given concept but incorporates only those characteristics that are relevant to a particular viewpoint

General Concept:

contextualized concept

Dictionary Basis:

a particular way in which some thing may be considered; its particular nature, appearance, or quality; the particular part or feature of it [NODE 'aspect']

Synonym: [aspect](#)

aspect

See: [facet](#)

viewpoint

Definition: perspective from which something is considered

concept has facet

Definition: *the [facet](#) generalizes the [concept](#) and incorporates* only those [characteristics](#) that are relevant to a particular [viewpoint](#)

14.4 Elements of Concept System Structure

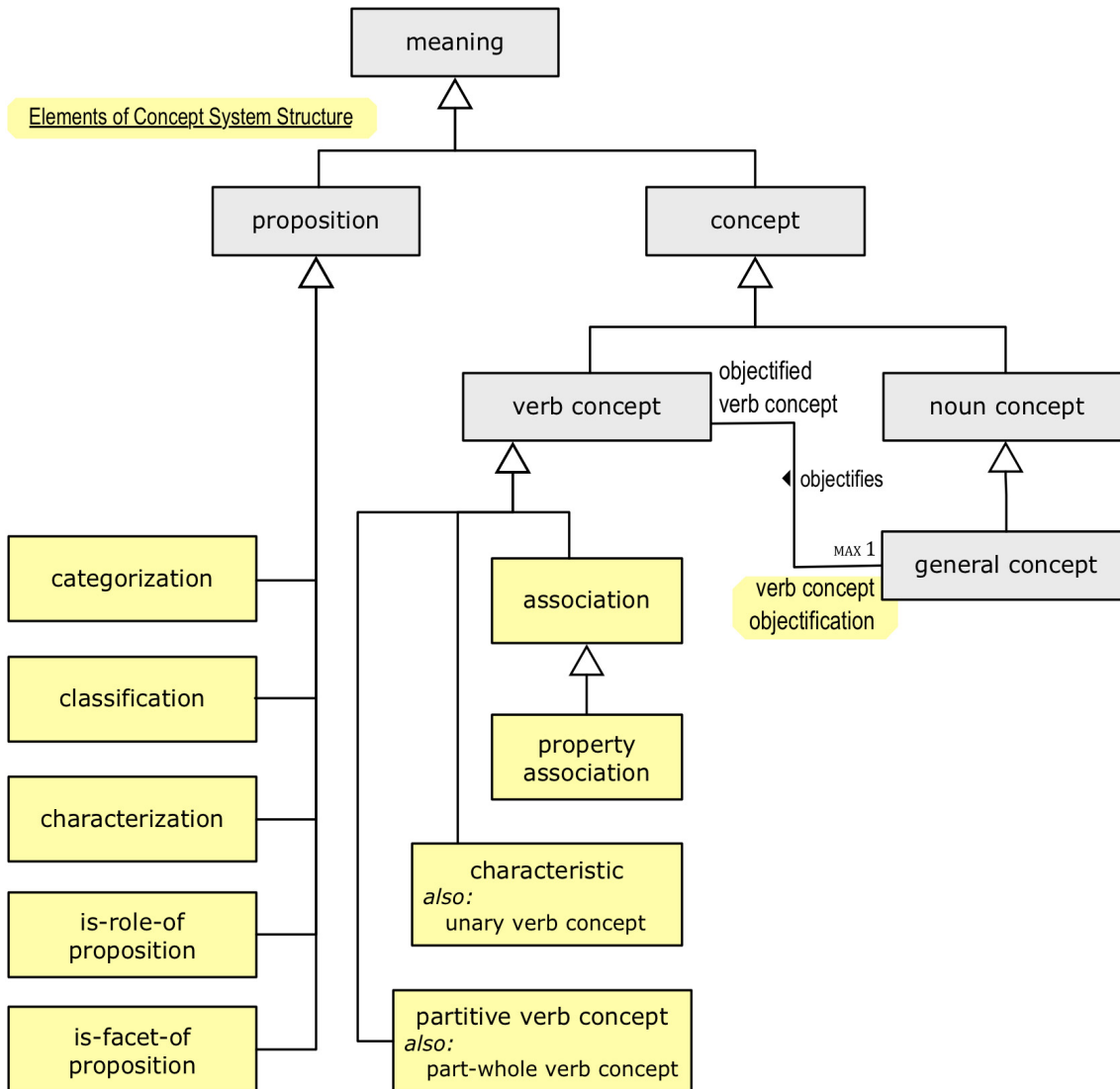

Figure 14.10 - The Elements of Concept System Structure

Elements of Concept System Structure

- Definition: [the categorization scheme of the concept 'meaning' that classifies a meaning](#) based on its part in organizing a community's concept system
- Necessity: [The concept 'association' is included in Elements of Concept System Structure.](#)
- Necessity: [The concept 'property association' is included in Elements of Concept System Structure.](#)
- Necessity: [The concept 'characteristic' is included in Elements of Concept System Structure.](#)
- Necessity: [The concept 'partitive verb concept' is included in Elements of Concept System Structure.](#)
- Necessity: [The concept 'categorization' is included in Elements of Concept System Structure.](#)

- Necessity: [The concept 'classification' is included in Elements of Concept System Structure.](#)
- Necessity: [The concept 'characterization' is included in Elements of Concept System Structure.](#)
- Necessity: [The concept 'is-role-of proposition' is included in Elements of Concept System Structure.](#)
- Necessity: [The concept 'is-facet-of proposition' is included in Elements of Concept System Structure.](#)
- Necessity: [The concept 'verb concept objectification' is included in Elements of Concept System Structure.](#)

14.5 Conceptualization Choices

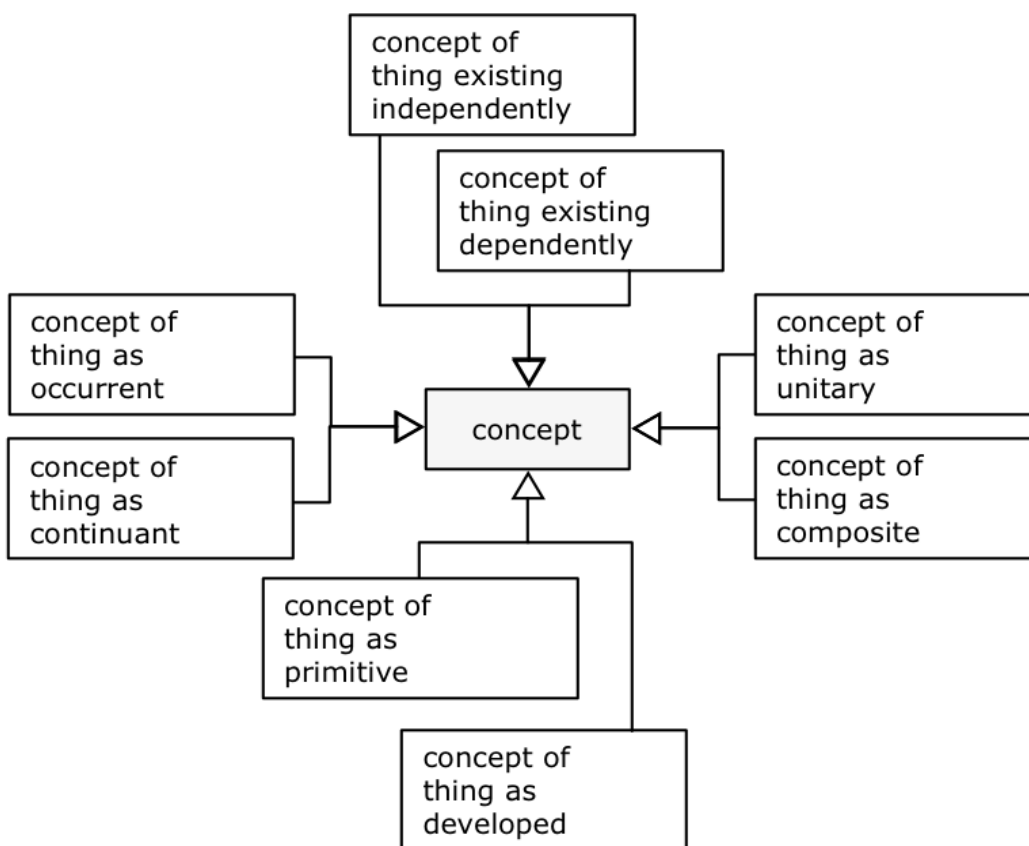

Figure 14.11 - Kinds of Conceptualization Choice

concept of thing as unitary

- Definition: [concept](#) that conceptualizes its [instances](#) as **not** being made up of discrete parts or elements
- Note: A thing is conceptualized as unitary if a semantic community doesn't think of it as having components, even though some other community may be aware of and concerned about its decomposition.
- Example: EU-Rent finance department treats a car as unitary, while its maintenance staff treat it as composite.

concept of thing as composite

Definition: concept that conceptualizes its instances as being made of discrete parts or elements that have corresponding concepts in their own right

Necessity: No concept of thing as unitary is a concept of thing as composite.

concept of thing as primitive

Definition: concept that conceptualizes its instances as **not** being developed or derived from anything else

Dictionary Basis: not developed or derived from anything else [NODE 'primitive']

concept of thing as developed

Definition: concept that conceptualizes its instances as being developed or derived from something else

Necessity: No concept of thing as primitive is a concept of thing as developed.

concept of thing as occurrent

Definition: concept that conceptualizes its instances as existing only at a point in time

Dictionary Basis: the fact of something existing or being found in a place or under a particular set of conditions [NODE 'occurrence' 2] + the fact or frequency of something happening [NODE 'occurrence' 1]

concept of thing as continuant

Definition: concept that conceptualizes its instances as existing over a period of time

Dictionary Basis: a thing that retains its identity even though its states and relations may change. [NODE 'continuant' 2]

Necessity: No concept of thing as occurrent is a concept of thing as continuant.

concept of thing existing independently

Definition: concept that conceptualizes **each instance** to exist independently of other things such that existence cannot be ended by the ending of the existence of any other thing

concept of thing existing dependently

Definition: concept that conceptualizes **each instance** as existing only as long as one or more other things continue to exist

Necessity: No concept of thing existing independently is a concept of thing existing dependently.

15 Elementary Concepts

15.1 Introduction

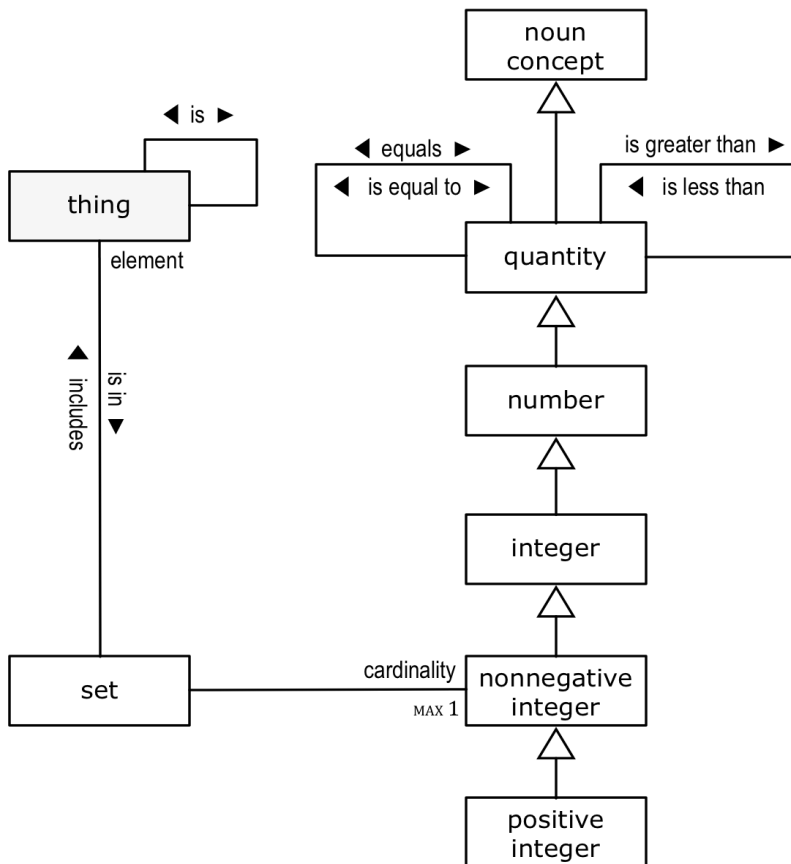

Figure 15.1 - Quantities, Numbers, and Sets

15.2 Quantities

quantity

Definition:

aspect in which a [thing](#) is measurable in terms of greater, less, or equal [MWU]

General Concept:

[noun concept](#)

Note:

The concept [quantity](#) can be elaborated into mathematical systems, such as integers and real numbers, and into systems of measures. This specification elaborates only the concepts for integer, because they are commonly used in definitional rules. For measurement systems and units of measure there are accepted vocabularies and perhaps standard ontologies, but the specification of such a vocabulary is beyond the scope of this specification.

quantity₁ equals quantity₂

Definition: the quantity₁ is mathematically equivalent to the quantity₂

Synonymous Form: quantity₁ is equal to quantity₂

quantity₁ is less than quantity₂

Definition: the quantity₁ is mathematically less than the quantity₂

Synonymous Form: quantity₂ is greater than quantity₁

15.3 Numbers

number

Definition: quantity belonging to an abstract mathematical system and subject to laws of succession, addition, and multiplication

Dictionary Basis: An arithmetical value, expressed by a word, symbol, or figure, representing a particular quantity and used in counting and making calculations [ODE: "number," 1]

Note: The ISO 6093 Number Namespace has designations for decimal numbers.

integer

Definition: number that has no fractional part

FL

nonnegative integer

Definition: integer that is greater than or equal to zero

FL

positive integer

Definition: nonnegative integer that is not equal to zero

FL

15.4 Sets

set

Definition: collection of zero or more things considered together without regard to order or repetition

FL

thing is in set

Definition: the thing is a member of the set

Synonymous Form: set includes thing

Synonymous Form: set has element

FL

element

Concept Type: role

Definition: thing that is in a set

cardinality

Definition: nonnegative integer that is the number of distinct elements in a given set or collection

Concept Type: role

Note: The means of distinguishing things as elements of a set is dependent on the kind of thing and the viewpoint taken in constructing each kind of set. Reference schemes may be used in this regard.

FL

set has cardinality

FL

Definition:

the cardinality is the number of distinct elements in the set

Necessity:

Each set has at most one cardinality.

16 Business Rules

16.1 Elements of Guidance

16.1.1 Introduction

The *common sense* understanding of ‘rule’ is that a rule always tends to remove some degree of freedom. This *common sense* understanding should be contrasted with that for ‘advice’, where a degree of freedom is never removed, even potentially.

The degree of freedom removed by a rule might concern the behavior of people (in the case of an behavioral business rule), or their understanding of concepts (in the case of a definitional rule). In the latter case, the restricting of freedom is built-in (i.e., “definitional” or “by definition”). In the former case, people can still potentially violate or ignore the rule - that is a matter of free will, appropriate enforcement, and sometimes discretion (for example if the rule is offered simply as a guideline or suggestion).

Nonetheless, an behavioral business rule always mandates or suggests some out-of-bounds criteria for behavior, thereby potentially removing a degree of freedom. For example, the meaning of “It is prohibited that an order be paid by promissory note” indicates that workers are not completely free to accept IOUs for payment of orders. That particular degree of freedom has been removed or diminished. Depending on enforcement level, violating the rule could well invite response, which might be anything from immediate prevention and/or severe sanction, to mild tutelage. Note that other degrees of freedom have not been removed or diminished by this particular rule. For example, unless other rules pertain to how orders are paid, workers are free to accept cash, credit cards, or other means of payment - those means are allowed. The general implication is that rules indirectly prescribe what is allowable - whatever the rules do not specifically proscribe is allowed.

An advice is just the opposite of a rule. Whereas a rule always potentially removes some degree of freedom, an advice always confirms or reminds that some degree of freedom does exist or is allowed. That degree of freedom might concern the behavior of people (in the case of an behavioral business rule), or their understanding of concepts (in the case of a definitional rule).

It might be helpful to think of an advice as an ‘un-rule’ or ‘no-rule’. For example, the meaning of “It is permitted that an order be paid by cash” is that such behavior is allowed - that indeed, paying by cash is acceptable. In other words, there is (or should be) no rule to the contrary.

Since an advice never removes degrees of freedom, why is it sometimes useful to capture? There are many possible reasons, but probably foremost among them are to re-assure workers or others that some degree of freedom does exist; to use as a basis for admonishing workers about applying some rule that actually does not exist; or to ‘remember’ the resolutions to some rule-related issue where the outcome was in favor of ‘no rule’.

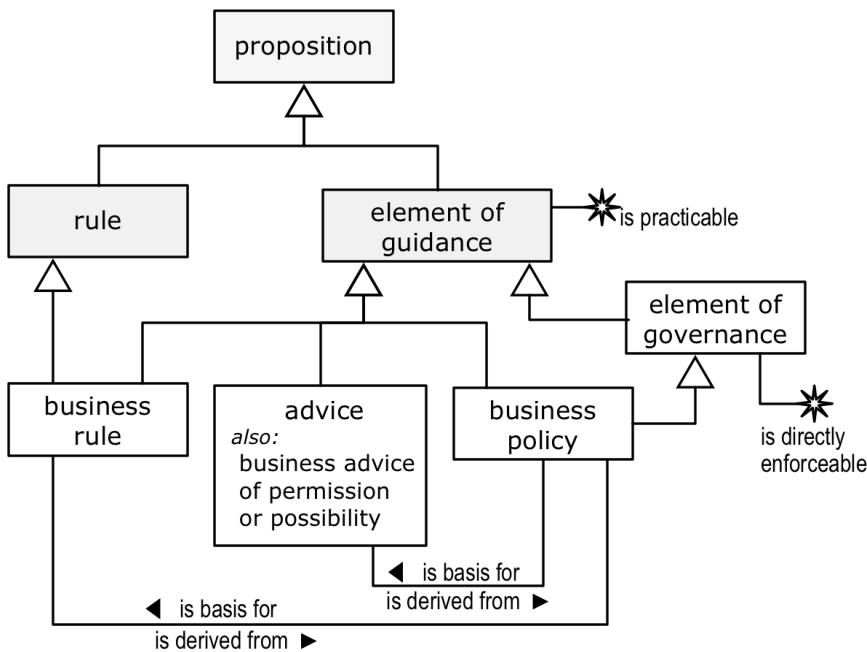

Figure 16.1 - Kinds of Element of Guidance

16.1.2 Business Rules and Advices

business rule

Definition:

rule that is practicable and that is under business jurisdiction

General Concept:

element of guidance

Note:

A rule's being under business jurisdiction means that it is under the jurisdiction of an authority that can opt to change or discard the rule at its own discretion. Laws of physics may be relevant to a company; legislation and regulations may be imposed on it; external standards and best practices (other than business rules) may be relied upon. These things are not business rules from the company's perspective, since it does not have the standing to change them. The company will decide how to react to laws and regulations, and will create or adopt business rules to ensure compliance with the laws and regulations. Similarly, it will create or adopt business rules to ensure that standards or best practices (other than business rules) are implemented as intended. See sub clause A.2.3.

Note:

See sub clause E.2.3 and the OMG's Business Motivation Model [BMM], which shares the concepts 'business policy' and 'business rule' with SBVR. In the BMM, business policy and business rule are kinds of directive, and regulation is a kind of influencer. Influencers are related indirectly to directives, via potential impact and assessment. This supports stake holders of the business in identifying the impacts of influencers on the business and then assessing what directives are needed to deal with these impacts. The enterprise BMM can provide information on earlier, relevant assessments, the directives that were created or

changed, the courses of action that were adopted, and the desired results (which can be compared with actual results if they are available).

There is also a special relationship between directive and regulation - that a directive from an authoritative source within an enterprise may be treated like a regulation by other organization units in the enterprise. For example, if the Health and Safety Unit of a business issued a directive about safe handling of products and materials, other organization units (such as Manufacturing, Warehousing and Distribution) would treat it as a regulation, in that they would have to comply with it in an acceptable way, although their assessments of its impact on their operations and their decisions on compliance might well be different.

element of guidance is practicable

Concept Type: [characteristic](#)

Definition: [the element of guidance](#) is sufficiently detailed and precise that a person who knows [the element of guidance](#) can apply it effectively and consistently in relevant circumstances to know what behavior is acceptable or not, or to what things a concept corresponds

Dictionary Basis: able to be done or put into practice successfully; able to be used, useful [ODE]

Note: The sense intended is: "It's actually something you can put to use or apply."

Note: The behavior, decision, or calculation can be that person's own.

Note: Whether or not some element of guidance is practicable is decided with respect to what a person with legitimate need can understand from it.

- For a behavioral business rule, this understanding is about the behavior of people and what form compliant behavior takes.
- For a definitional rule, this understanding is about how evaluation of the criteria vested in the rule always produces some certain outcome(s) for a decision or calculation as opposed to others.

Note: A practicable business rule is also always free of any indefinite reference to people (e.g., "you," "me"), places (e.g., "here"), and time (e.g., "now"). By that means, if the person is displaced in place and/or time from the author(s) of the business rule, the person can read it and still fully understand it, without (a) assistance from any machine (e.g., to "tell" time), and (b) external clarification.

business rule is derived from business policy

Synonymous Form: [business policy is basis for business rule](#)

advice

Definition: [element of guidance that is practicable and that is a proposition that permits a state of affairs or that acknowledges as possible a given state of affairs](#)

Necessity: [No business policy is an advice.](#)

Necessity: [No business rule is an advice.](#)

Synonym: [business advice of permission or possibility](#)

advice is derived from business policy

Synonymous Form: [business policy is basis for advice](#)

16.1.3 Elements of Governance

element of governance

- Definition: [element of guidance](#) that is concerned with directly controlling, influencing, or regulating the actions of an enterprise and the people in it
- Dictionary Basis: conduct the policy, actions, and affairs of (a state, organization, or people) with authority: control, influence, or regulate (a person, action, or course of events) [ODE, “govern”]

element of governance *is directly enforceable*

- Definition: violations of [the element of governance](#) can be detected without the need for additional interpretation of [the element of governance](#)
- Concept Type: [characteristic](#)
- Note: ‘Directly enforceable’ means that a person who knows about the element of governance could observe relevant business activity (including his or her own behavior) and decide directly whether or not the business was complying with the element of governance.
- Necessity: [Each element of governance that is directly enforceable is practicable.](#)

business policy

- Definition: [element of governance](#) *that is not directly enforceable* whose purpose is to guide an enterprise
- Note: Compared to a Business Rule, a Business Policy tends to be:
- less structured
 - less discrete or not atomic
 - less carefully expressed in terms of a standard vocabulary
 - not directly enforceable.
- Dictionary Basis: definite course or method of action selected (as by a government, institution, group, or individual) from among alternatives and in the light of given conditions to guide and usually determine present and future decisions [MWUD “Policy” 5a]
- Necessity: [No business policy is a business rule](#)
- Example: The policy expressed as “A prisoner is considered to be on a hunger strike after missing several meals in a row.”
- Example: The policy expressed as “The prison medical authority will intervene if a hunger striker’s life is in danger.”
- Example: The EU-Rent policy expressed as “Rental cars must not be exported.”
- Example: The policy expressed as “Each customer who complains will be personally contacted by a representative of the company.”

16.2 Element of Guidance Statements

The surface syntax people use to express guidance is language-specific. It is also dependent on the particular rule language (e.g., SBVR Structured English, RuleSpeak, ORM, etc.). This clause does not standardize any particular rule language. Instead, it provides a normative vocabulary for the kinds of guidance statements that business people assert. These kinds of guidance statements are general with respect to any particular language.

The categories presented in this sub clause are intended for business people. Business people see and hear surface syntax. Therefore, the categories defined in sub clauses 17.2 and 18.2 are based on form or style of expression. For example, if a

business person says “It is obligatory that not p,” the form or style of the expression remains an obligation statement. That interpretation reflects the ‘common sense’ of the statement.

This emphasis on form or style of expression distinguishes this sub clause from Clause 24, which provides deeper logical analysis. For example, if a business person says “It is obligatory that not p,” logical analysis following Clause 24 takes the meaning of the expression to be a prohibition (which might not be “common sense”). The key to distinguishing the perspective of this sub clause from the logical analysis of Clause 24 is emphasized by the unfailing use of “statement” in the names of the concepts for element of guidance statements. When “statement” appears in Clauses 16, 17, and 18, it is always the case that the concept so named refers to the style and form of surface expression, rather than underlying meaning based on logical analysis.

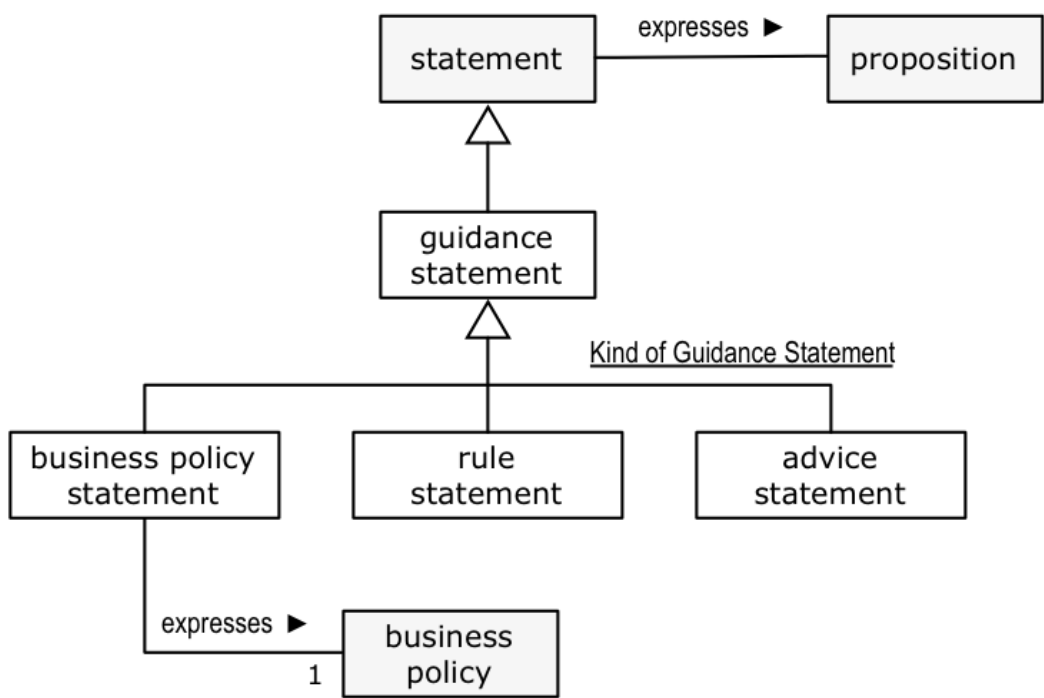

Figure 16.2 - Guidance Statement and Kinds of Guidance Statement

guidance statement

- Definition: [statement](#) that [expresses an element of guidance](#)
- Definition: [statement](#) that provides advice or information aimed at resolving a problem or difficulty, especially as given by someone in authority
- Dictionary Basis: a statement that provides advice or information aimed at resolving a problem or difficulty, especially as given by someone in authority [NODE 'guidance']

Kind of Guidance Statement

- Definition: [the categorization scheme](#) of [the concept 'guidance statement'](#) that [classifies a guidance statement based on](#) the surface syntax of [the guidance statement](#)

business policy statement

Definition: guidance statement that expresses a business policy

Necessity: The concept 'business policy statement' is included in Kind of Guidance Statement.

rule statement

Definition: guidance statement that expresses an behavioral business rule or a definitional rule

Necessity: The concept 'rule statement' is included in Kind of Guidance Statement.

advice statement

Definition: guidance statement that expresses an advice of permission or an advice of possibility

Necessity: The concept 'advice statement' is included in Kind of Guidance Statement.

16.3 Fundamental Principles for Elements of Guidance

16.3.1 The Severability Principle

Principle: The meaning of an element of guidance may be expressed separately from any other element of guidance; nonetheless, a body of shared guidance that includes the element of guidance will be evaluated as if all the elements of guidance had been expressed jointly and all had to hold true.

In everyday business, elements of guidance are individual elements of meaning that exist separately. Often, they are also expressed separately – e.g., by individual sentences. In a body of shared guidance of any size, such separate expression of dissimilar or disjoint elements of guidance is a practical necessity for readability and manageability.

In SBVR, a body of shared guidance is nonetheless logically considered as a whole. In other words, each element of guidance is always applied in all situations where that element of guidance is relevant – even if expressed separately. This is true even if the element of guidance is expressed without direct reference to related elements of guidance that are relevant for the same situation.

This fundamental understanding is called the *Severability Principle*.¹

The MWUD definition of “severable” is:

capable of being severed ... ; especially : capable of being divided into legally independent rights or obligations used of a statute or contract of which the part to be performed consists of distinct items to which the consideration may be apportioned so that the invalidity or failure of performance as to one item does not necessarily affect the others

This captures the sense of what SBVR means by ‘severable’. If one element of guidance is invalidated or violated somehow, the rest still apply.

It should be noted that expressing elements of guidance separately and without reference to related elements of guidance may increase the chance of conflicts, but does not create it per se. Even a single element of guidance can have internal conflicts. Conflicts must be resolved by proper specification, including cases where exceptions are intended, as discussed in 16.4.

1. This SBVR principle is the business counterpart to what in propositional logic is often called the *universal ‘and’*. This assumption requires that all separate Propositions be true (for a body of shared guidance). Therefore, an implicit ‘and’ must be considered to exist between all such Propositions.

It should also be noted that the *Severability Principle* does not apply across separate bodies of shared guidance. Therefore conflicts and exceptions, as discussed in 16.4, can only exist within a single body of shared guidance. They cannot exist across two or more bodies of shared guidance.

16.3.2 The Accommodation Principle

Principle: An element of guidance whose meaning conflicts with some other element(s) of guidance must be taken that way; if no conflict is intended, the element(s) of guidance must be expressed in such a way as to avoid the conflict.

Exceptions to elements of guidance must be accommodated explicitly; that is, cases where exceptions to elements of guidance are intended must be worded in such a way to avoid any conflict in the meanings.

In SBVR, statements can mean only what the actual words presented in the statements indicate they mean. Therefore, to indicate that an exception is intended always requires additional or alternative specification (i.e., *accommodation*). Otherwise the meanings of the statements would simply (and necessarily) be taken to be in conflict.

16.3.3 The Wholeness Principle

Principle: An element of guidance means only exactly what it says, so it must say everything it means.

Each element of guidance must be self-contained; that is, no need to appeal to any other element(s) of guidance should ever arise in understanding the full meaning of a given element of guidance.

The full impact of an element of guidance for a body of shared guidance, of course, cannot be understood in isolation. For example, an element of guidance might be in conflict with another element of guidance, or act as an authorization in the body of shared guidance. The *Wholeness Principle* simply means that if a body of shared guidance is deemed free of conflicts, then with respect to guidance, the full *meaning* of each element of guidance does not require examination of any other element of guidance. In other words, each element of guidance can be taken at face value for whatever it says.

16.4 Accommodations, Exceptions, and Authorizations

16.4.1 Authorizations

SBVR makes a ‘light world’² assumption about rules. In a *light world*, anything that is not expressly prohibited is assumed permitted, and anything not expressly declared as impossible is assumed possible. Business rule practice indicates that this choice is the appropriate one for the large majority of business problems.

Occasionally, practitioners may discover ‘dark areas in a light world’ – areas in which the opposite assumption is appropriate. In such a *dark area*, anything not expressly permitted is assumed prohibited, or anything not expressly declared as possible is assumed impossible. Dark areas of the former kind – the more important and common of the two cases – might involve use of, and/or access to, resources that are deemed especially sensitive, dangerous, scarce, and/or valuable. For that reason, it makes sense to grant permission for use and/or access explicitly. Such permissions are often called ‘authorizations’.

In everyday business language, an *authorization* is generally understood to mean a sanction or a warrant [MWUD].

2. Ronald G. Ross, “The Light World vs. the Dark World ~ Business Rules for Authorization,” *Business Rules Journal*, Vol. 5, No. 8 (August 2004), URL: <http://www.BRCommunity.com/a2004/b201.html>

[MWUD “sanction” noun]: 6a. explicit permission or recognition by one in authority that gives validity to the act of another person or body

[MWUD “warrant” noun]: 2a. a commission or document giving authority to do something : an act, instrument, or obligation by which one person authorizes another to do something which he has not otherwise a right to do and thus secures him from loss or damage

For SBVR, it is important to note that an authorization is *explicit* (from “sanction”), and that without it, there is *not otherwise a right to do something* (from “warrant”).

16.4.2 Exceptions

Authorizations fall under the more general topic of *exception*. In everyday business language, to ‘make an exception’ is generally understood to mean [MWUD “exception” 1] “the act of excepting or excluding: exclusion or restriction (as of a class, statement, or rule) by taking out something that would otherwise be included.” An ‘exception’ is what is omitted from consideration.

In SBVR, the *Severability Principle* permits elements of guidance to be given separately (individually), raising the possibility that one element of guidance might actually be intended as an exception with respect to another. The general element of guidance and its exceptions are always in the same body of shared guidance.

SBVR’s approach to exceptions, which includes authorizations, is based on the fundamental principles for elements of guidance given in sub clause 16.3. The following describes how exceptions and authorizations may be specified in SBVR.

16.4.3 Approaches to Capturing Accommodations, Exceptions, and Authorizations

Approach 1 – General Elements of Guidance that Accommodate More Specific Cases

This approach uses the verb concepts specified in sub clause 8.6.3 to allow for more specific cases to be specified for some more general element of guidance. This discussion will use the ‘[element of guidance authorizes state of affairs](#)’ verb concept, but it should be noted that the other two verb concepts would be applied similarly, as appropriate to the business situation.

A state of affairs being ‘authorized’ means that some specific element of guidance in a body of shared guidance entails that the state of affairs may validly occur, i.e., is not an error or conflict with the more general rule. Support for exceptions (and authorizations) in this approach is accomplished as follows.

- A behavioral business rule is specified to declare that some given area of business activity is prohibited except where there is some explicit advice of permission given (i.e., a ‘dark’ area is declared).
- Explicit advice(s) of permission, qualified as appropriate, are specified to declare selective exceptions/authorizations. Without such permissions, there would otherwise be no right to do something.

In general, a *logical OR* is always assumed between the more specific cases given separately from the more general element of guidance. The body of shared guidance can contain any number of ‘exceptions’ to general cases without introducing conflicts as long as the general case element of guidance allows for exceptions.

The two Examples illustrate different subjects for authorization. The first authorizes an action (use of a vehicle on an ice road) under given conditions, whereas the second authorizes people to carry out an action (making a payment).

EXAMPLE

Two guidance statements, expressing a general rule and a more specific case for EU-Rent:

Vehicle Usage Rule

A vehicle may use an ice road only if the use is authorized by a Vehicle Usage Advice.

Arctic Circle Exemption

Any ice road that is north of the Arctic Circle may be used by any vehicle.

The Arctic Circle Exemption is a Vehicle Usage Advice.

These elements of guidance work together like this:

The first element (an behavioral business rule) sets up the *dark area*, prohibiting any use that is not explicitly authorized. It does this by use of the verb concept 'element of guidance authorizes state of affairs'.

The second element is one of perhaps many Vehicle Usage Advices. The concept 'Vehicle Usage Advice' is a category of advices within EU-Rent's body of shared guidance.

Note that this Example assumes the standard SBVR constructs have been used, e.g., 'vehicle' and 'ice road' are assumed to be defined terms; as well as the verb concept (vehicle uses ice road) being defined and objectified as 'use'. For simplicity, 'being north of the Arctic Circle' is taken to be a characteristic of an ice road, but other, more elaborate solutions could have been worked out.

EXAMPLE

Three guidance statements, expressing a general case and two more specific cases, with facts that classify the specific cases and connect them to the general case:

Guidance Statements:

Payments Business Rule

A person may *make* a payment *only if* a Payment Authorization *authorizes* that the person *make* the payment.

Senior Manager Exemption

Any senior manager may *make* any payment.

Jane Smith may *make* any payment.

Facts:

The Senior Manager Exemption *is* a Payment Authorization.

“Jane Smith may *make* any payment” *is* a Payment Authorization.

The first element (an behavioral business rule) sets up the *dark area*, prohibiting any payment that is not explicitly authorized. The verb concept used is ‘element of guidance authorizes state of affairs’.

The second element is a blanket advice of permission that allows any person who is a senior manager to make a payment. The third element stipulates that a specific person (Jane Smith) may make payments.

This Example assumes the defined verb concept ‘person makes payment’. It also assumes that the terms used are defined (e.g., person, payment) and that Jane Smith is a known person (and no assumption beyond that is made about her). The two facts classify the second and third elements as ‘Payment Authorizations’, a category of advices of permission in the body of shared guidance, and thus relate them to the general case, in which ‘Payment Authorization’ plays a role.

Regarding any person and payment, the *exception condition* of the rule statement is that the person be explicitly permitted to make the payment, either directly (as in the case of Jane Smith) or indirectly (as in the case of any senior manager). The advice of permission statements express, for certain persons and any payment, that a person is permitted to make the payment. It can be determined, for every instance of the verb concept ‘person makes payment’, that the condition is satisfied. As long as a person satisfies either *exception condition* of the rule, that person is permitted to make any payment – i.e., that he or she has ‘authorization’.

Approach 2 – Using a Business Concept

Another acceptable approach, illustrated below by a reworking of the second Example given for Approach 1, is that the business has some concept(s) to help express authorizations.

EXAMPLE

Consider the following rule and supporting statements that use the concept ‘[authorized payer](#)’, which has been defined as “[person that may make any payment](#)”.

Rule Statement: *Only an [authorized payer](#) may make a [payment](#).*

Specification of Authorized Payers:

- *Each [senior manager](#) is an [authorized payer](#).*
- *[Jane Smith](#) is an [authorized payer](#).*

Given the definition of ‘[authorized payer](#)’, these two statements meet the same business requirement as the advice statements in the second Example given for Approach 1 – that senior managers and Jane Smith may make any payment. Regardless of the definition of ‘[authorized payer](#)’, these two statements clearly satisfy the condition of the rule statement by identifying instances of ‘[authorized payer](#)’, which is the concept considered by the condition in the rule.

Approach 3 – Formulating Elements of Guidance to Avoid Exceptions

A third approach is to simply specify a set of elements of guidance whose conditions are mutually-exclusive.

EXAMPLE

Two rules, expressed as individual statements with mutually-exclusive conditions:

1. *The [state sales tax](#) must be charged on each [order](#) shipped within the state.*
2. *The [state sales tax](#) must not be charged on an [order](#) shipped out-of-state.*

Note that the second rule above would not be considered to be “an exception” to the first. Rather, its expression includes “out-of-state” to differentiate it from orders shipped “within the state”. This accommodation avoids a collision between the meanings of the rules that would otherwise arise.

17 Definitional Guidance

17.1 Definitional Elements of Guidance

17.1.1 Introduction

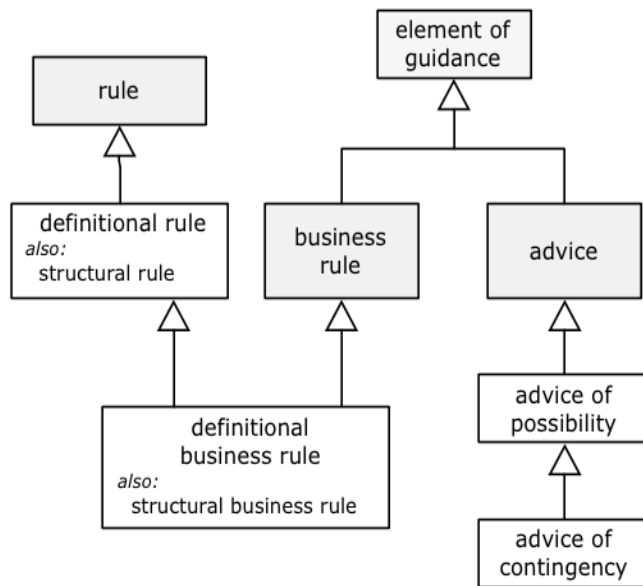

Figure 17.1 - Kinds of Definitional Elements of Guidance

17.1.2 Definitional Rules

definitional rule

- Definition: [rule that necessitates a given state of affairs](#)
- Synonym: [structural rule](#)
- Example: Newton's first law of motion is a "rule of nature" - i.e., not under business jurisdiction. This definitional rule is commonly expressed as:
A body at rest will stay at rest unless acted on by an outside force.
- Example: EU-Rent requires that a rental is for one car group (economy, compact, full-size, etc.). This definitional business rule can be expressed as:
It is necessary that each rental has exactly one car group.
Alternatively:
Each rental always has exactly one car group.

structural rule

- See: [definitional rule](#)

definitional business rule

- Definition: [definitional rule that is a business rule](#)
Necessity: [Each definitional business rule is practicable.](#)
Synonym: [structural business rule](#)

structural business rule

- See: [definitional business rule](#)

17.1.3 Definitional Advices

advice of possibility

- Definition: [advice that acknowledges as possible a given state of affairs](#)
Note: Every definitional rule implies an advice of possibility. Consider the definitional rule expressed as:
[It is necessary that each rental has exactly one car group](#)
Alternatively:
[Each rental always has exactly one car group](#)
This definitional rule implies an advice of possibility that can be expressed as:
It is possible that a [rental has exactly one car group](#).
Alternatively:
[A rental can have exactly one car group](#)
There is no practical reason, however, to express the advice of possibility implied by a definitional rule explicitly. In such cases, best practice generally favors keeping the number of elements of guidance to be managed to a minimum.
Example: (In a bank) The element of guidance that “It is possible that an account balance is negative.”
Definition: [No advice of possibility is an advice of permission.](#)

advice of contingency

- Definition: [advice of possibility that does not necessitate a given state of affairs](#)
Note: The purpose of an advice of contingency is to preempt application of definitional “rules” that might be assumed to exist, but are not actually included in the body of shared guidance of the authority. Often, the reason for this assumption in a business is that other, similar businesses have such rules. Typically, the reason for providing such explicit advice is that people in the business have mistakenly applied the non-existent rule in the past.
Note: In alethic logic, a proposition that is possible but not necessary is termed ‘contingent’. If people in a business were to treat it as a definitional rule, they would miscategorize things in the real world. This typically leads to refusal of activity (that should be permitted) because unnecessary preconditions are not met, e.g., refusing to accept a rental booking because the person wishing to rent is under 21.
Example: (In EU-Rent) Advising that it is not necessary for a qualified driver to be over 21. This might be expressed in various ways, for example as: “It is neither necessary nor impossible that the age of a qualified driver is at least 21,” or “It is possible (but not necessary) that a qualified driver be under 21.”
Example: (In EU-Rent) Advising that it is not necessary for a bad experience that occurs during a rental to be notified before the end of the rental. This might be expressed in various ways, for example as: “It is neither necessary nor impossible that the notification date/time of a bad experience during a rental is the actual return date/time of the rental or earlier.” It is possible

(but not necessary) that the notification of a bad experience during a rental occurs after the car has been returned.”

17.2 Definitional Element of Guidance Statements

17.2.1 Statements of Definitional Rules

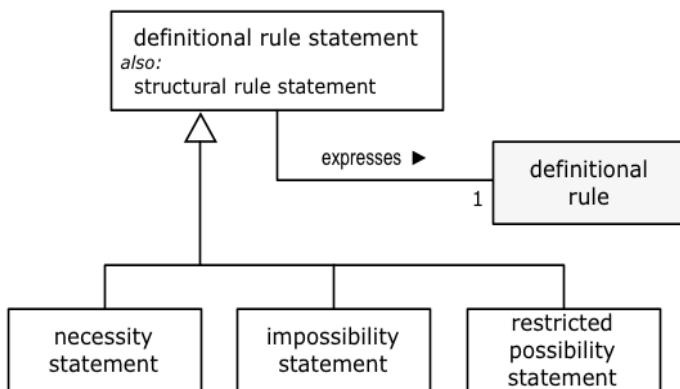

Figure 17.2 - Definitional Rule Statement and Kinds of Definitional Rule Statement

definitional rule statement

- Definition: [rule statement](#) that **expresses** a [definitional rule](#)
- Synonym: [structural rule statement](#)
- Note: One definitional rule can be expressed as various equivalent kinds of statements by introducing or removing negation. The following are examples of the same rule, expressed in three forms.
- Example: [as a [necessity statement](#)] “**It is necessary that** the pick-up branch of a one-way rental is not the return branch of that rental.”
- Example: [as an [impossibility statement](#)] “**It is impossible that** the pick-up branch of a one-way rental is the return branch of that rental.”
- Example: [as a [restricted possibility statement](#)] “**It is possible that** the pick-up branch of a rental is the return branch of the rental **only** if the rental is not a one-way rental.”

structural rule statement

- See: [definitional rule statement](#)

necessity statement

- Definition: [definitional rule statement](#) that is worded as the [state of affairs being](#) necessary **or being always** the case
- Note: Contrast this with a definitional rule statement worded as the state of affairs being impossible.
- Necessity: **No** [necessity statement is an impossibility statement](#).
- Necessity: **No** [necessity statement is a restricted possibility statement](#).
- Example: “It is necessary that each rental has exactly one requested car group.”

Example: “Each rental always has exactly one requested car group.”

impossibility statement

Definition: definitional rule statement that is worded as the state of affairs being impossible or being never the case

Note: Contrast this with a definitional rule statement worded as the state of affairs being necessary.

Necessity: No impossibility statement is a restricted possibility statement.

Example: “It is impossible that the same rental car is owned by more than one branch.”

Example: “The same rental car is never owned by more than one branch.”

restricted possibility statement

Definition: definitional rule statement that is worded as the state of affairs being possible only if a given condition is met or being possibly the case only if a given condition is met

Example: “It is possible that a rental is an open rental only if the rental car of the rental has been picked up.”

Example: “A rental can be an open rental only if the rental car of the rental has been picked up.”

Note: A restricted possibility statement should not be confused with a statement of advice of possibility. The latter should never contain ‘only’, which is always interpreted as eliminating or diminishing a degree of freedom (i.e., indicating the presence of a rule). This inclusion of ‘only’ is the key characteristic of restricted possibility statements.

Note: Every restricted possibility statement can be rephrased as a conditional impossibility statement. The pattern “it is possible that p only if q ” can be stated equivalently as “it is impossible that p if not q ” or “it is not possible that p if not q ” (refer to Clause 24). For example, the following three statements mean the same thing:

1. “It is possible that a rental is an open rental only if the rental car of the rental has been picked up.”
2. “It is impossible that a rental is an open rental if the rental car of the rental has not been picked up.”
3. “It is not possible that a rental is an open rental if the rental car of the rental has not been picked up.”

17.2.2 Statements of Definitional Advices

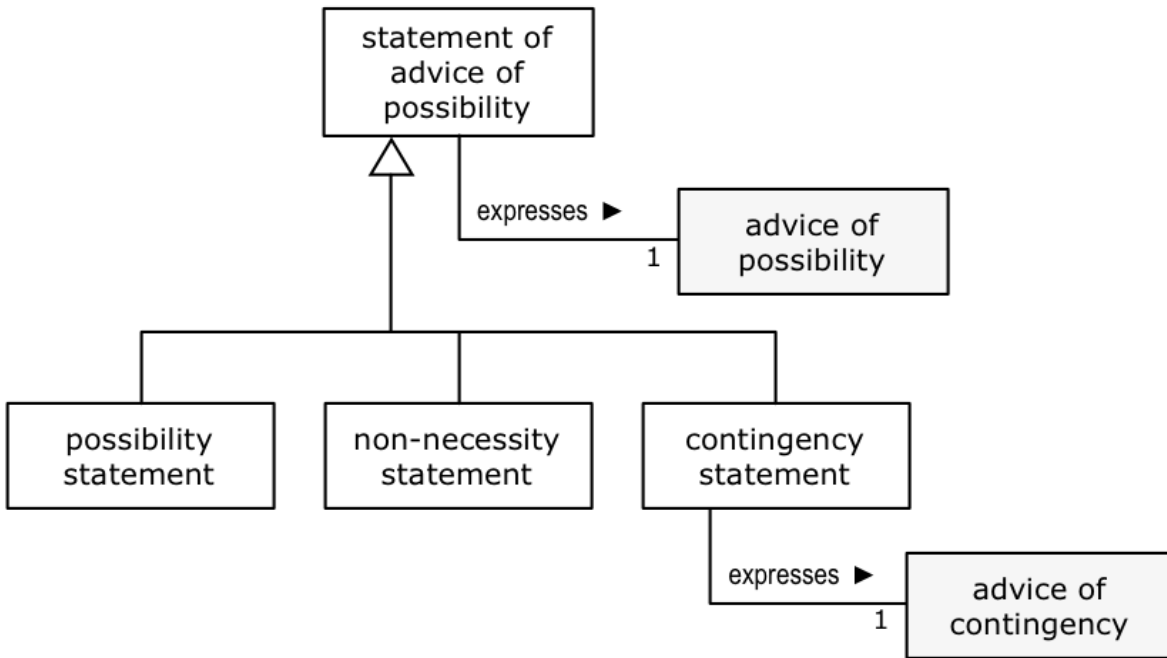

Figure 17.3 - Statement of Advice of Possibility and its Kinds

statement of advice of possibility

- Definition: [advice statement](#) that [expresses](#) an [advice of possibility](#)
- Example: “The notification date/time of a bad experience that occurs during a rental can be after the actual return date/time of the rental.”
- Necessity: [No statement of advice of possibility is a statement of advice of permission.](#)
- Note: One advice of possibility can be expressed as various equivalent kinds of statements by introducing or removing negation. The following are examples of the same advice, expressed in two forms.
- Example: [as a [possibility statement](#)] “It is possible that the notification date/time of a bad experience that occurs during a rental is after the actual return date/time of the rental.”
- Example: [as a [non-necessity statement](#)] “It is not necessary that the notification date/time of a bad experience that occurs during a rental be on or before the actual return date/time of the rental.”

possibility statement

- Definition: [statement of advice of possibility](#) that is worded as [the state of affairs being](#) possible or [being](#) able to be the case
- Note: Contrast this with a statement of advice of possibility worded as the state of affairs being not necessary.
- Necessity: [No possibility statement is a non-necessity statement.](#)

Example: “It is possible that the notification date/time of a bad experience that occurs during a rental is after the actual return date/time of the rental.”

Example: “The notification date/time of a bad experience that occurs during a rental can be after the actual return date/time of the rental.”

non-necessity statement

Definition: [statement of advice of possibility](#) that is worded as [the state of affairs not being](#) necessary [or](#) possibly [not always being](#) the case

Note: Contrast this with a statement of advice of possibility worded as the state of affairs being possible.

Example: “It is not necessary that the notification date/time of a bad experience that occurs during a rental be on or before the actual return date/time of the rental.”

Example: “The notification date/time of a bad experience that occurs during a rental is not always on or before the actual return date/time of the rental.”

contingency statement

Definition: [statement of advice of possibility](#) that [expresses an advice of contingency](#)

Note: A [contingency statement](#) may take various forms, each expressing the meaning of the same [advice of contingency](#), as illustrated by the following examples.

Example: “It is possible but not necessary that a renter’s age is less than 21 years.”

Example: “It is neither impossible nor necessary that a renter’s age is less than 21 years.”

17.3 Connections between Definitional Rules and Concepts

Definitional rules often, but not always, propose necessary characteristics of concepts. Here are three cases:

1. A definitional rule uses universal quantification (e.g., “each” or “all”) to propose a necessary characteristic of a concept. The definitional rule proposes that something is always true about all instances of the concept.
2. A definitional rule proposes a necessary characteristic of an individual noun concept - no universal quantification is used because it is implicit in referring to the one and only instance of the individual noun concept.
3. Cases other than 1 and 2 above: a definitional rule does not propose a necessary characteristic of a concept, but it proposes something to be necessarily true. See Rule 4 in the examples below.

A fact that a concept has a necessary characteristic is a definitional rule that the characteristic is always true about each instance of the concept. How is it a definitional rule? It is a proposition that the necessary characteristic is always true of each instance of the concept. Conversely, a definitional rule proposes that a characteristic is a necessary characteristic of a concept if and only if the definitional rule proposes that the characteristic is always true about each instance of the concept. The definitional rule does not imply that the concept incorporates the characteristic, because necessary characteristics can be either incorporated or implied.

There is a logical connection between concepts and definitional rules. A starting point of the logical connection is these two necessary truths about concepts:

1. For each concept, each characteristic it incorporates is attributed to each instance of the concept.
2. For each individual noun concept, the instance of the individual noun concept exists.

From this starting point, considering concepts together, there are any number of propositions can be proved to be true by logical implication. A definitional rule is logically connected to concepts when it proposes that one of these propositions is necessarily true. Definitional rule statements often facilitate a deeper understanding of concepts, but a definitional rule never changes a concept. Rather, it proposes what logically follows from an understanding of concepts, and in some cases, from business decisions that define specific thresholds.

In cases where definitions of concepts taken together do not logically imply something proposed in a definitional rule statement, there is an inadequacy or mistake in either the relevant definitions or in the rule statement. The case of inadequate definitions is common and is acceptable in some communities. It occurs when a community shares a tacit understanding of many of its concepts. Words either have no explicit definitions or have definitions that use words that have no explicit definitions. Definitional rule statements in this context can be correct, even if they logically follow from a tacit understanding of what characteristics are incorporated by concepts.

Practices of developing concept systems range from creating highly precise, rigorously complete definitions for all concepts to creating no or few definitions, or largely descriptive or informal ones, but many definitional rules. Where highly precise, rigorously complete definitions are given there is less need for definitional rules because such rules would appear redundant. Where definitions are missing or unclear, or largely descriptive or informal, definitional rules are important to sharing a common understanding of concepts.

Advices of possibility relate to concepts following the same pattern by which definitional rules relate to concepts.

Where there is a definition, a concept is just what the definition says, no more and no less. Something called a “definition” as used in common speech is not necessarily a definition as defined by SBVR. It might be just a general description. It is only a definition if it defines the concept, differentiating it from others. As a matter of practice, a simple test for adequacy and correctness of definitions is to restate a rule by substituting a definition of a concept into a rule statement in place of the concept’s designation. Does the restatement express the same meaning as the original statement? If not, the so-called definition is inadequate or incorrect. Consider the example below:

sports car

Definition: kind of car

Rule 1: A rental of a sports car must include collision coverage.

A restatement of Rule 1, “A rental of a kind of car must include collision coverage,” expresses a different meaning, so the definition is inadequate. Here is an adequate definition:

sports car

Definition: small, fast automobile equipped for racing

When the adequate definition is substituted into a restatement of the rule, the same rule is expressed. Consider some examples of definitional rules related to ‘sports car’.

Rule 2: Each sports car is always small.

Rule 2 expresses a characteristic attributed to all sports cars by the definition of ‘sports car’. It is an incorporated characteristic of ‘sports car’.

Rule 3: Each Corvette is always a sports car.

Rule 3 does not change the meaning of ‘sports car’. Rather, it expresses an understanding that every Corvette is a small, fast automobile equipped for racing. This understanding is found in the meaning of Corvette. Agreement on this understanding might come from analysis of a definition of ‘Corvette’, or it might be established by a business decision about meaning based on tacit knowledge. Definitional rules expressing such business decisions are often important guides to business knowledge.

EU-Rent Speedway

Definition: the test track owned by EU-Rent where any small car is testable

Rule 4: A test track always exists.

Rule 4 follows logically from the individual noun concept 'EU-Rent Speedway'. An individual noun concept always has one instance. So there is always a EU-Rent Speedway, and therefore, a test track.

Rule 5: The EU-Rent Speedway is always in Germany.

Rule 5 does not appear to follow logically from an understanding of definitions. It might well be true that the EU-Rent Speedway is in Germany, but Rule 5 proposes that it is always true - true in all possible worlds. Definitional rules are about what is true in all possible worlds, so a statement of a fact, not a rule, is more appropriate here:

Fact 6: The EU-Rent Speedway is in Germany.

Rule 7: Every sports car is always testable at the EU-Rent Speedway.

Finally, Rule 7 proposes a necessary characteristic of the concept 'sports car'. This characteristic is an implied characteristic because it is not an incorporated characteristic of 'sports car'. It follows logically from the combination of characteristics of 'sports car' and 'EU-Rent Speedway'.

18 Behavioral Guidance

18.1 Behavioral Elements of Guidance

18.1.1 Introduction

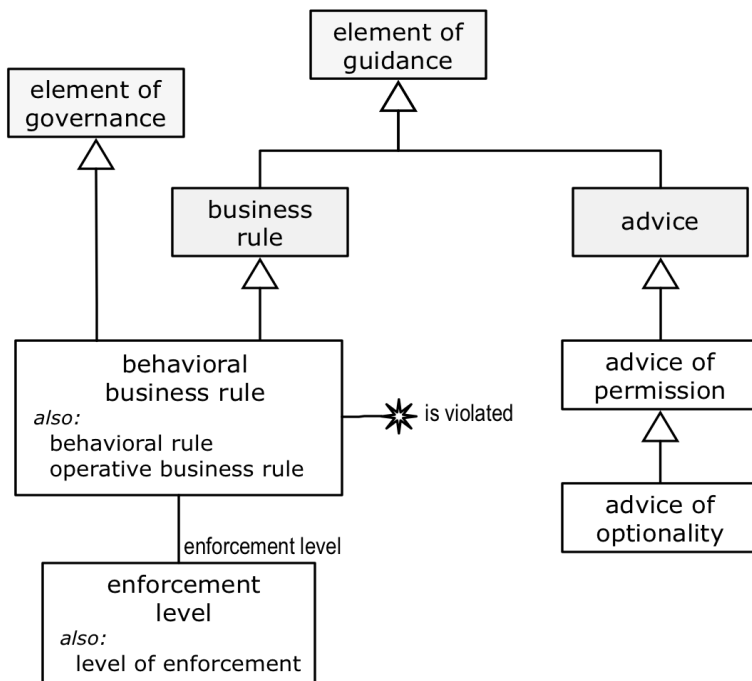

Figure 18.1 - Kinds of Behavioral Elements of Guidance

18.1.2 Behavioral Rules

behavioral business rule

Definition: business rule that obligates a given state of affairs

Example: It is obligatory that each open rental is guaranteed by a credit card that is held by the renter who is responsible for the rental

Alternatively:

Each open rental must be guaranteed by a credit card that is held by the renter who is responsible for the rental

Definition: element of governance that is directly enforceable

Dictionary Basis: a prescribed, suggested, or self-imposed guide for conduct or action : a regulation or principle <his parents laid down the rule that he must do his homework before going out to play> <a very sound rule for any hiker is to mind his own business [...] F.D.Smith & Barbara Wilcox> <made it a rule never to lose his temper> [...] [MWU (1a) 'rule']

Dictionary Basis: a prescribed guide for conduct or action [MWCD 'rule']
Necessity: No behavioral business rule is a definitional business rule.
Synonym: operative business rule

operative business rule

See: behavioral business rule

behavioral business rule is violated

Definition: the state of affairs that is obligated by the behavioral business rule is not an actuality or the state of affairs that is obligated by the behavioral business rule not to be an actuality is an actuality

Example: EU-Rent has concerns about regulations pertaining to taking cars across national borders and consequent implications for insurance coverage, so it restricts the area for a rental. It has the following behavioral business rule, named the Area of Usage Rule:

Area of Usage Rule: No rented car of an open rental may be outside the authorized area of the rental.

Sample violation scenario: EU-Rent discovers that the rented car of an open rental is outside the area authorized for the rental. In other words, the behavioral business rule is violated by the rental.

In such circumstances, EU-Rent could respond by:

(1) Taking some remedial action such as canceling the rental. The required new state of affairs could be addressed by the following rule, which uses the verb concept "behavioral business rule is violated":

An open rental must be canceled if the Area of Usage Rule is violated by the rental.

Observations:

- Like all rules in SBVR, this rule takes no action; rather, it simply requires the 'canceled' state of affairs for the rental. Any action taken to cancel the order is outside the scope of the rule and of SBVR.
- This behavioral business rule governs the behavior of EU-Rent staff, whereas the *Area of Usage Rule* governs the behavior of EU-Rent's rental customers.

(2) Taking consequential actions – e.g., notifying the insurer; advising the renter that the rental is canceled and they are not insured and should not drive the car, recovering the car and charging the renter for the recovery, etc. Such actions, as before, are separate from the rule violation itself, and outside the scope of SBVR.

(3) Imposing some sanction – canceling any future rental contracts for the renter, and barring the renter from being an additional driver on current or future rentals. Applicable sanctions could be specified in the form of additional behavioral business rules, though any actions to apply them would again be separate and out of scope.

operative business rule

See: behavioral business rule

18.1.3 Business Rule Enforcement

enforcement level

Definition: position in a graded or ordered scale of values that specifies the severity of action imposed in order to put or keep a [behavioral business rule](#) in force

Dictionary Basis: a position on a real or imaginary scale of amount, quantity, extent, or quality [NODE 'level']

Dictionary Basis: compel observance of or compliance with [NODE 'enforcement']

Synonym: [level of enforcement](#)

Example: An example set of levels of enforcement, based on [BMM]

Enforcement Level: [strict](#)

Definition: strictly enforced (If you violate the rule, you cannot escape the penalty.)

Enforcement Level: [deferred](#)

Definition: deferred enforcement (Strictly enforced, but enforcement may be delayed — e.g., waiting for resource with required skills.)

Enforcement Level: [pre-authorized](#)

Definition: pre-authorized override (Enforced, but exceptions allowed, with prior approval for actors with before-the-fact override authorization.)

Enforcement Level: [post-justified](#)

Definition: post-justified override (If not approved after the fact, you may be subject to sanction or other consequences.)

Enforcement Level: [override](#)

Definition: override with explanation (Comment must be provided when the violation occurs.)

Enforcement Level: [guideline](#)

Definition: guideline (suggested, but not enforced.)

behavioral business rule has enforcement level

18.1.4 Behavioral Advices

advice of permission

Definition: [advice that permits a given state of affairs](#)

Note: Every behavioral business rule implies an advice of permission. Consider the behavioral business rule expressed as:

[Each open rental must be guaranteed by a credit card that is held by the renter who is responsible for the rental.](#)

This behavioral business rule implies an advice of permission that can be expressed as:

[It is permitted that an open rental be guaranteed by a credit card that is held by the renter who is responsible for the rental.](#)

There is no practical reason, however, to express the advice of permission implied by a behavioral business rule explicitly. In such cases, best practice generally favors keeping the number of elements of guidance to be managed to a minimum.

Example: (In a bank) There is no rule that a person must be over some given age in order to open a savings account: “There is no minimum age for opening a savings account.” This is understood as an advice of permission because ‘minimum age’ is defined as “age that must be reached in order to take part in a given activity” and no restriction has been placed on it. In other words, the behavior ‘opening a bank account’ is not to be disallowed based on age.

Example: There is no rule that orders placed by FAX will not be accepted: “Placing an order by FAX is acceptable.” In other words, placing an order by FAX is not prohibited.

advice of optionality

Definition: advice of permission that *does not obligate* a given state of affairs

Note: The purpose of an advice of optionality is to preempt application of behavioral "rules" that might be assumed to exist, but are not actually included in the body of shared guidance of the authority. Often, the reason for this assumption in a business is that other, similar businesses have such rules. Typically, the reason for providing such explicit advice is that people in the business have mistakenly applied the non-existent rule in the past.

Note: In deontic logic, a proposition that is permissible but not obligatory is termed ‘optional’. If people in a business were to treat it as an obligation, they would demand compliance that is not required by the business, e.g., to be shown picture id, or that the car be driven to the specified return branch (as the following examples illustrate).

Example: (In EU-Rent) Advising that it is not obligatory that a renter show picture identification at the time of a rental pick-up. This might be expressed in various ways, for example as: “It is neither obligatory nor prohibited that at rental pick-up time the renter shows picture identification,” or “It is not obligatory (but permitted) that a renter shows picture id in order to pick up his car.”

Example: (In EU-Rent) Advising that it is not obligatory (or prohibited) that a rented car be dropped off only at the return branch specified in the rental agreement. This might be expressed, for example, as “At the end of a rental, it is not obligatory (but permitted) that a rental car be dropped off at the rental agreement-specified EU-Rent return branch.”

18.2 Behavioral Element of Guidance Statements

18.2.1 Statements of Behavioral Rules

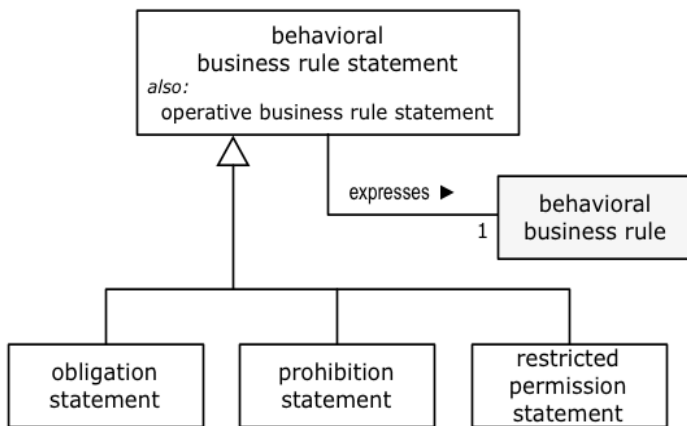

Figure 18.2 - Behavioral Rule Statement and Kinds of Behavioral Rule Statement

behavioral business rule statement

- Definition: [rule statement that expresses a behavioral business rule](#)
- Synonym: [operative business rule statement](#)
- Necessity: **No [behavioral business rule statement](#) is a [definitional rule statement](#).**
- Note: One behavioral business rule can be expressed as various equivalent kinds of statements by introducing or removing negation. The following are examples of the same rule, expressed in three forms.
- Example: [as an [obligation statement](#)] “It is obligatory that a rental that is open has no driver that is a barred driver.”
- Example: [as a [prohibition statement](#)] “It is prohibited that a rental be open if a driver of the rental is a barred driver.”
- Example: [as a [restricted permission statement](#)] “It is permitted that a rental be open only if no driver of the rental is a barred driver.”

operative business rule statement

- See: [behavioral business rule statement](#)

obligation statement

- Definition: [behavioral business rule statement](#) that is worded as **the [state of affairs being obligated](#)**
- Note: Contrast this with a behavioral business rule statement worded as the state of affairs being prohibited.
- Necessity: **No [obligation statement](#) is a [prohibition statement](#).**
- Necessity: **No [obligation statement](#) is a [restricted permission statement](#).**
- Example: “It is obligatory that a rental incurs a location penalty charge if the drop-off location of the rental is not the EU-Rent site of the return branch of the rental.”

Example: “A rental must incur a location penalty charge if the drop-off location of the rental is not the EU-Rent site of the return branch of the rental.”

prohibition statement

Definition: behavioral business rule statement that is worded as the state of affairs being prohibited

Note: Contrast this with a behavioral business rule statement worded as the state of affairs being obligated.

Necessity: No prohibition statement is a restricted permission statement.

Example: “It is prohibited that the duration of a rental be more than 90 rental days.”

Example: “The duration of a rental must not be more than 90 rental days.”

restricted permission statement

Definition: behavioral business rule statement that is worded as the state of affairs being permitted only if a given condition is met

Example: “It is permitted that a rental is open only if an estimated rental charge is provisionally charged to the credit card of the renter of the rental.”

Example: “A rental may be open only if an estimated rental charge is provisionally charged to the credit card of the renter of the rental.”

Note: A restricted permission statement should not be confused with a statement of advice of permission. The latter should never contain ‘only’, which is always interpreted as eliminating or diminishing a degree of freedom (i.e., indicating the presence of a rule). This inclusion of ‘only’ is the key characteristic of restricted permission statements.

Note: Every restricted permission statement can be rephrased as a conditional prohibition statement. The pattern “it is permitted that p only if q ” can be stated equivalently as “it is prohibited that p if not q ” or “it is not permitted that p if not q ” (refer to Clause 24). For example, the following three statements mean the same thing:

1. “It is permitted that a rental is open only if an estimated rental charge is provisionally charged to the credit card of the renter of the rental.”
2. “It is prohibited that a rental is open if an estimated rental charge is not provisionally charged to the credit card of the renter of the rental.”
3. “It is not permitted that a rental is open if an estimated rental charge is not provisionally charged to the credit card of the renter of the rental.”

18.2.2 Statements of Behavioral Advices

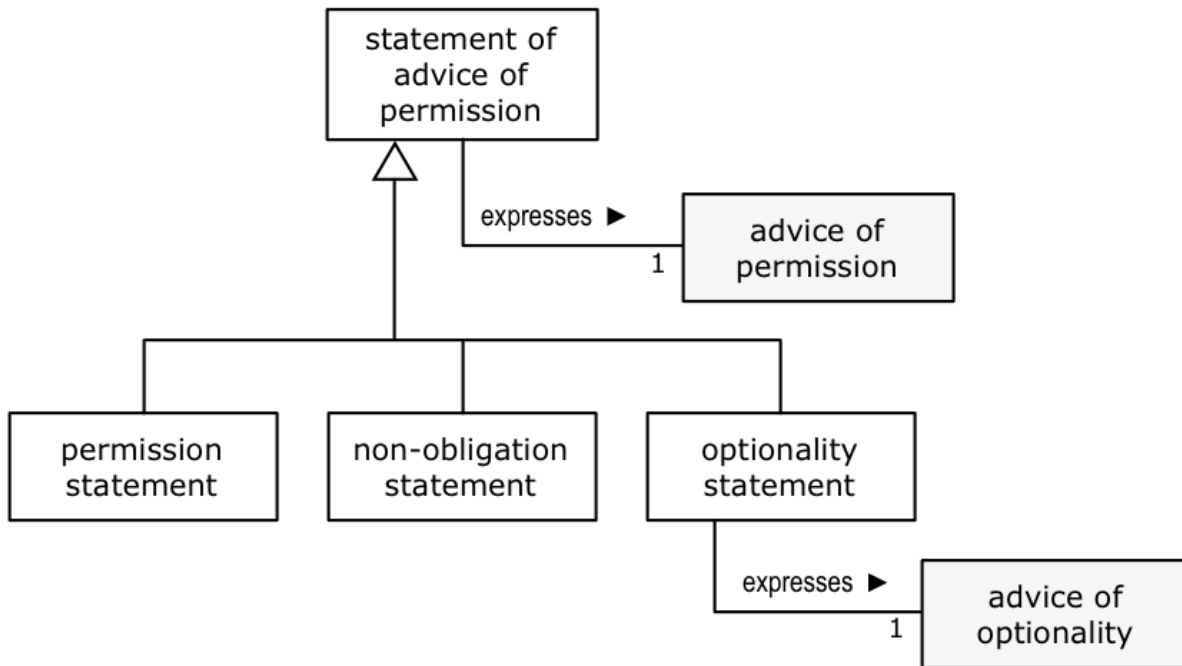

Figure 18.3 - Statement of Advice of Permission and its Kinds

statement of advice of permission

- Definition: [advice statement](#) that [expresses](#) an [advice of permission](#)
- Note: One advice of permission can be expressed as various equivalent kinds of statements by introducing or removing negation. The following are examples of the same advice, expressed in alternative forms.
- Example: [as a [permission statement](#)] “It is permitted that the drop-off branch of a rental is not the return branch of the rental.”
- Example: [as a [non-obligation statement](#)] “It is not obligatory that the drop-off branch of a rental be the return branch of the rental.”
- Example: [as a [non-obligation statement](#)] “The drop-off branch of a rental need not be the return branch of the rental.”

permission statement

- Definition: [statement of advice of permission](#) that is worded as [the state of affairs being permitted](#)
- Note: Contrast this with a statement of advice of permission worded as the state of affairs being not obligated.
- Necessity: [No permission statement is a non-obligation statement.](#)
- Example: “It is permitted that the drop-off branch of a rental is not the return branch of the rental.”
- Example: “The drop-off branch of a rental need not be the return branch of the rental.”

non-obligation statement

- Definition: statement of advice of permission that is worded as the state of affairs not being obligated
- Note: Contrast this with a statement of advice of permission worded as the state of affairs being permitted.
- Example: “It is not obligatory that the drop-off branch of a rental be the return branch of the rental.”
- Example: “The drop-off branch of a rental need not be the return branch of the rental.”

optionality statement

- Definition: statement of advice of permission that expresses an advice of optionality
- Note: An optionality statement may take various forms, each expressing the meaning of the same advice of optionality, as illustrated by the following examples.
- Example: “It is neither prohibited nor obligatory that the renter shows photo identification at the pick-up time of a rental.”
- Example: “It is permitted but not obligatory that the renter shows picture identification at the pick-up time of the rental.”

19 Business Collections of Meanings and Representations

19.1 Bodies of Meanings

19.1.1 Bodies of Shared Meaning

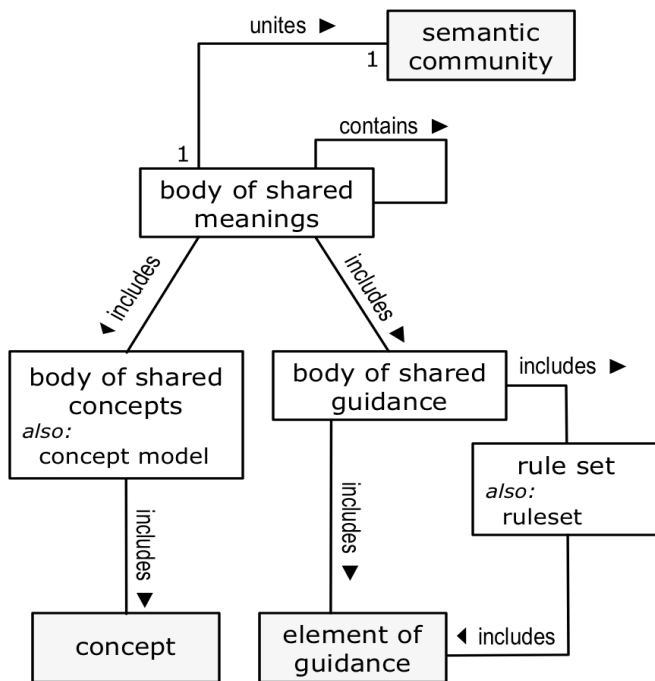

Figure 19.1 - A Body of Shared Meanings and its Composition

body of shared meanings

Definition: [set of concepts and elements of guidance](#) for which there is a shared understanding in a [given semantic community](#)

Example: The [EU-Rent Car Rental Business](#) has a [body of shared meanings](#) which contains the set of concepts of general and specific things of importance to the EU-Rent car rental business.

Note: When modeling a business (such as EU-Rent), the universe of discourse, defined in the body of shared meanings, is bounded by what the business owners decide is in scope. That would be the actual world of some part of EU-Rent's business (e.g., rentals, as opposed to, say, premises management, purchase/sales of cars, or HR) and some possible worlds that are reachable from the actual world. If the EU-Rent owners say that they are considering renting RVs or starting up in China, then meanings about possible worlds that include these kinds of business are included in the body of shared meanings.

If EU-Rent is not considering renting construction equipment or camping gear, then meanings about possible worlds that include these kinds of business are not included in the body of

shared meanings – and neither are possible worlds that include impossibilities. Whether

‘Kinnell Construction rented backhoe 123 on 2012-08-28’ or ‘John rode into work on a unicorn’ correspond to states of affairs or not, are not relevant to EU-Rent. They are out of scope.

In-scope propositions may have to be constrained by necessities to ensure that they are not impossible. e.g., ‘Necessity: Each rental car is stored at at most one branch [at any given time].’

Note:

A body of shared meanings contains meanings of:

- noun concepts that define kinds of thing in the business, within the scope being modeled
- verb concepts that define relationships between kinds of thing in the business, within the scope being modeled
- elements of guidance that constrain or govern the things and relationships defined by the concepts.

It does not contain ground facts or facts derived from ground facts (other than as illustrative examples), or things in the business, or information system artifacts that model things in the business – although it may provide vocabulary to refer to them.

body of shared meanings unites semantic community

Definition: **the body of shared meanings is the set of concepts and elements of guidance for which there is a shared understanding in the semantic community**

Necessity: **Each semantic community is united by exactly one body of shared meanings.**

Necessity: **Each body of shared meanings unites exactly one semantic community.**

Note: Understanding the body of shared meanings that unites a semantic community is an obligation for participation in the semantic community. Communication within the community is based on an assumption of mutual understanding of the body of shared meaning.

body of shared meanings₁ contains body of shared meanings₂

Concept Type: **partitive verb concept**

Definition: **the body of shared meanings includes everything in the other body of shared meanings**

19.1.2 Bodies of Shared Concepts

body of shared concepts

Definition: all of the concepts within a body of shared meanings, structured according to the relations among them

Synonym: **concept model**

Note: Clause 14 and sub clause 11.2 provide detail for what is meant by “the relations among [concepts]” in this Definition.

body of shared concepts includes concept

Concept Type: **partitive verb concept**

Synonymous Form: **concept is included in body of shared concepts**

body of shared meanings includes body of shared concepts

19.1.3 Bodies of Shared Guidance

body of shared guidance

Definition: all of **the** elements of guidance within **a** body of shared meanings

body of shared meanings includes body of shared guidance

Definition: **the** body of shared guidance **is the set of** elements of guidance **that are included in the** body of shared meanings

Synonymous Form: body of shared guidance **is included in** body of shared meanings

body of shared guidance includes element of guidance

Synonymous Form: element of guidance **is included in** body of shared guidance

rule set

Definition: **set of one or more** elements of guidance within **a** body of shared guidance

Synonym: ruleset

ruleset

See: rule set

body of shared guidance includes rule set

Synonymous Form: rule set **is included in** body of shared guidance

rule set includes element of guidance

Synonymous Form: element of guidance **is included in** rule set

19.2 Sets of Business Representations

19.2.1 Business Vocabularies

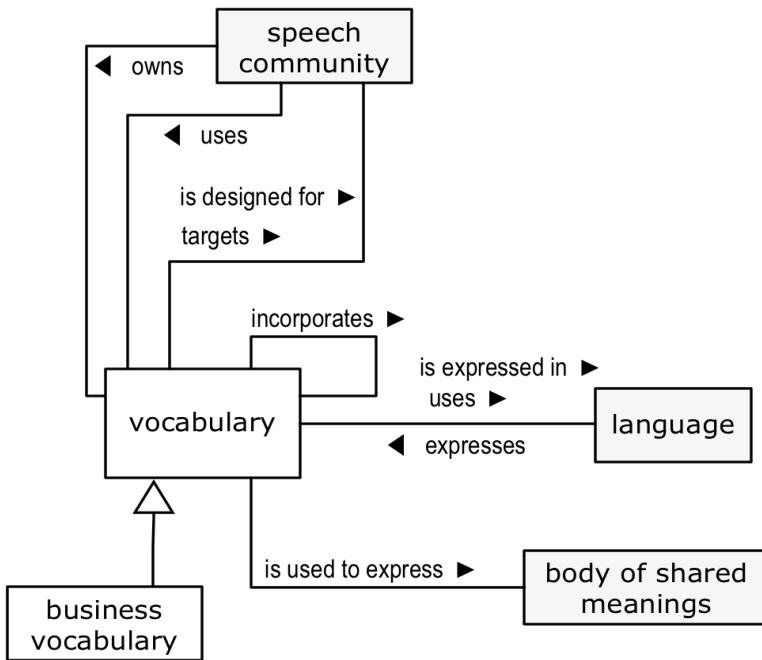

Figure 19.2 - Business Vocabulary

vocabulary

Definition: [set of designations](#) and [verb concept wordings](#) primarily drawn from [a single language](#) to express [concepts](#) within [a body of shared meanings](#)

Dictionary Basis: sum or stock of words employed by a language, group, individual, or work, or in a field of knowledge [MWCD 'vocabulary']

Example: The sets of designations represented in EU-Rent's internal glossaries, in the natural languages in which the company does business, together with the vocabularies it has adopted, including those defined in:

- * Industry standard glossaries for car rental business,
- * Standard (e.g., ISO) glossaries of business terms,
- * Authoritative dictionaries for the relevant natural languages.

Note: A vocabulary contains only designations and verb concept wordings. Contrast with a terminological dictionary, which further adds definitions, descriptions, etc. Also contrast with an SBVR rulebook, which includes everything that is in a terminological dictionary plus representations of behavioral elements of guidance in a body of shared guidance.

Note: Enumerating the designations in a vocabulary is not a matter of listing signifiers, but of associating signifiers with concepts, and a concept can be identified by a definition.

business vocabulary

Definition: [vocabulary](#) that is under business jurisdiction

vocabulary is expressed in language

- Definition: the designations of the vocabulary are primarily within the language
- Synonymous Form: language expresses vocabulary
- Synonymous Form: vocabulary uses language
- Necessity: Each vocabulary is expressed in at least one language.
- Note: Typically, the language would be a natural language, but not necessarily. See 'language'.

speech community owns vocabulary

- Definition: the speech community determines the contents of the vocabulary
- Note: The speech community that owns a vocabulary has the authority to change the content of the vocabulary.

speech community uses vocabulary

- Note: A speech community may use a vocabulary that is owned by a different speech community.

vocabulary is designed for speech community

- Synonymous Form: vocabulary targets speech community
- Definition: the vocabulary is created for use by a speech community that does not own the vocabulary
- Example: A speech community of specialists (such as accountants of engineers) creates a “layman’s vocabulary” for their specialization, to be used in discourse with general management.
- Example: The legal department of a company creates a vocabulary to be used for legal documents, such as contracts.

vocabulary₁ incorporates vocabulary₂

- Concept Type: partitive verb concept
- Definition: the vocabulary₁ includes each designation and verb concept wording that is included in the vocabulary₂
- Note: When more than one vocabulary is included, a hierarchy of inclusion can provide priority for selection of definitions.
- Synonymous Form: vocabulary₂ is incorporated into vocabulary₁

vocabulary is used to express body of shared meanings

- Definition: the vocabulary includes designations and verb concept wordings of the concepts in the body of shared meanings

19.2.2 Speech Community Representation Sets

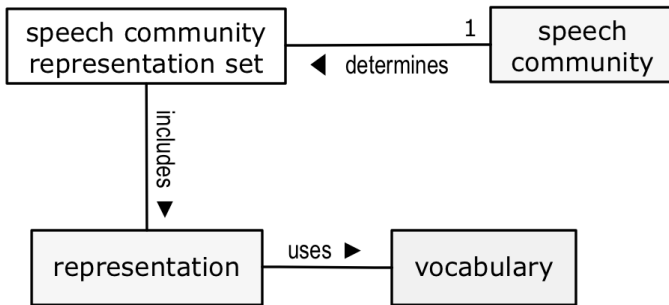

Figure 19.3 - Speech Community Representation Set

speech community representation set

Definition: set of representations determined by a given speech community to represent in its language all meanings in its body of shared meanings

Synonym: representation set

Reference Scheme: the speech community that determines the speech community representation set

Note: Besides being an element of a speech community representation set, an individual representation can appear multiple times

1. as a component of other representations in that set - e.g., a term can be used in multiple definitions and statements, and
2. in terminological dictionaries and/or rulebooks - once for each time the meaning of the representation appears in the terminological dictionary or rulebook.

speech community representation set includes representation

Definition: the representation is an element in the speech community representation set

Synonymous Form: representation is included in speech community representation set

representation uses vocabulary

Definition: the representation is expressed based on the vocabulary

speech community determines speech community representation set

Definition: the speech community is responsible for the expression of representations that are included in the speech community representation set

Necessity: Each speech community representation set is determined by exactly one speech community.

Note: The speech community is responsible for translating the informal representations of the speech community representation set into the language of the speech community.

19.3 Ways of Packaging SBVR Content for Publication

19.3.1 Terminological Dictionaries

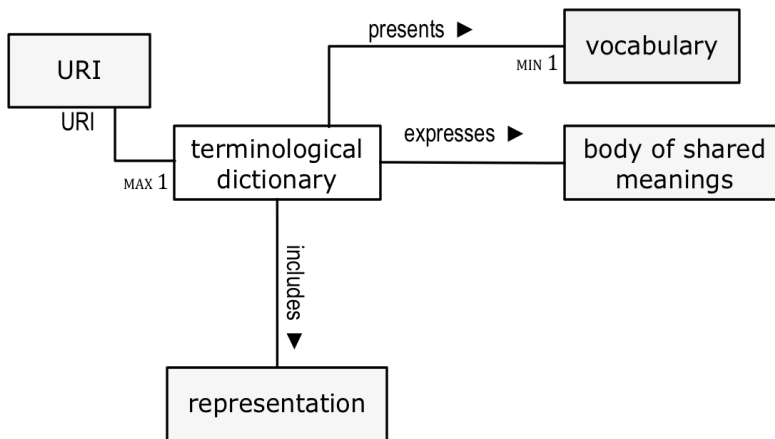

Figure 19.4 - Terminological Dictionary

terminological dictionary

Definition: collection of [representations](#) including **at least one designation or definition of each** of a [set of concepts](#) from **one or more** specific [subject fields](#), together with other specifications of [facts](#) related to those [concepts](#)

Source: **based on** [ISO 1087-1 English](#) (3.7.1) [ISO1087-1]

Reference Scheme: **a** [URI of the terminological dictionary](#)

Note: Terminological dictionaries include designations and verb concept wordings representing concepts, and definitions, descriptions, descriptive examples, notes, definitional rule statements and other representations of information about the concepts.

Note: Contrast a terminological dictionary with a rulebook, which may include representations of behavioral elements of guidance in a body of shared guidance.

terminological dictionary includes representation

Definition: **the** [representation](#) is an element of **the** [terminological dictionary](#)

Synonymous Form: [representation is included in terminological dictionary](#)

terminological dictionary has URI

Definition: **the** [URI](#) uniquely identifies **the** [terminological dictionary](#)

Necessity: **Each** [URI](#) **is the** [URI of at most one terminological dictionary](#).

terminological dictionary presents vocabulary

Definition: **the** [terminological dictionary](#) sets forth representations related to **the** [designations and verb concept wordings](#) of **the** [vocabulary](#)

Necessity: Each [terminological dictionary](#) *presents* at least one [vocabulary](#).

Note: Which terminological entries are to be included in a terminological dictionary is specified by one or more vocabularies by using the verb concept [terminological dictionary presents vocabulary](#). Vocabularies may be assembled from other vocabularies using the verb concept [vocabulary₁ incorporates vocabulary₂](#). Terminological dictionaries can effectively include other terminological dictionaries by including the vocabulary(ies) that specifies the terminological entries in the **included** terminological dictionary in the vocabulary that specifies the terminological entries in the **including** terminological dictionary.

[terminological dictionary expresses body of shared meanings](#)

Definition: the [terminological dictionary](#) *includes* [representations of the concepts in the body of shared meanings](#)

19.3.2 Rulebooks

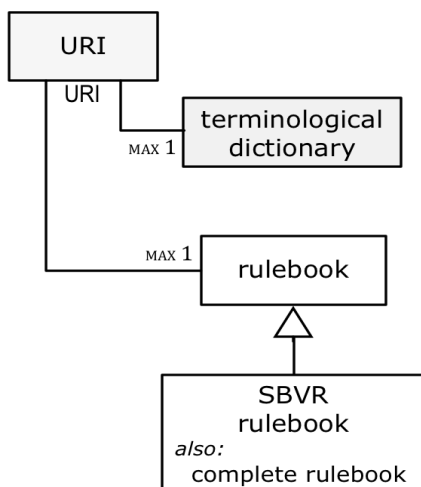

Figure 19.5 - Rulebook

[rulebook](#)

Definition: collection of [representations](#) including at least one [guidance statement](#) for each of a set of one or more [elements of guidance](#), together with any number of other [representations of facts](#) related to those [elements of guidance](#), plus any number of terminological entries for [designations](#) used in the [guidance statements](#)

Reference Scheme: a [URI of the rulebook](#)

Note: A rulebook may optionally include as "the other representations of facts related to its elements of guidance": names of elements of guidance, synonymous statements, terms for guidance types, descriptions, references, notes, descriptive examples, and other representations (e.g., regarding enforcement levels for behavioral rules).

[rulebook has URI](#)

Definition: the [URI](#) uniquely identifies the [rulebook](#)

Necessity: Each [URI](#) *is the URI of* at most one [rulebook](#).

SBVR rulebook

- Definition: [rulebook](#) that includes a [terminological dictionary](#) containing terminological entries for all of the [designations](#) that are used in the [guidance statements](#) and that are not implicitly understood
- Synonym: [complete rulebook](#)
- Note: Rulebooks are not always complete with respect to the meanings of terms and wordings. The meanings of some terms and wordings may be expressed in descriptive text, clarified by one or more definitional rules, illustrated by examples, etc. An SBVR rulebook, in contrast, is always complete with explicit definitions for all designations that are used in the guidance statements and that are not implicitly understood.

complete rulebook

- See: [SBVR rulebook](#)

19.4 Business Contents of a Communication

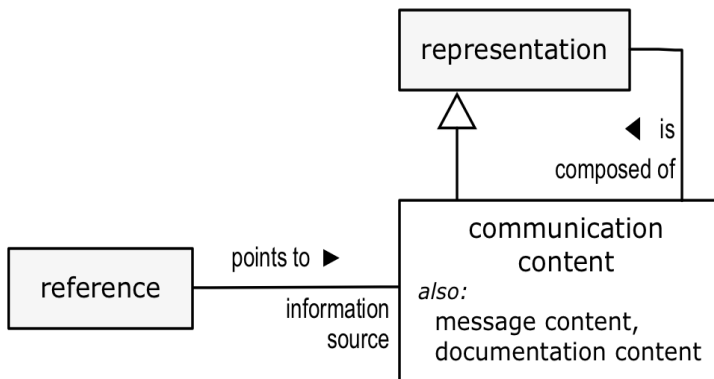

Figure 19.6 - Communication Content

communication content

- Definition: [representation](#) that is a subdivision of a written composition that consists of **one or more** statements and deals with one point or gives the words of one speaker
- Source: [MWCD \(1a\)](#)
- Synonym: [message content](#)
- Synonym: [document content](#)

message content

- See: [communication content](#)

document content

- See: [communication content](#)

communication content is composed of representation

- Concept Type: [partitive verb concept](#)

information source

Concept Type: [role](#)

Definition: [communication content](#) that is used as a resource to supply information or evidence

reference points to information source

Definition: the [communication content](#) plays the role of an [information source](#) for the [reference](#)

19.5 Namespaces

19.5.1 Namespace

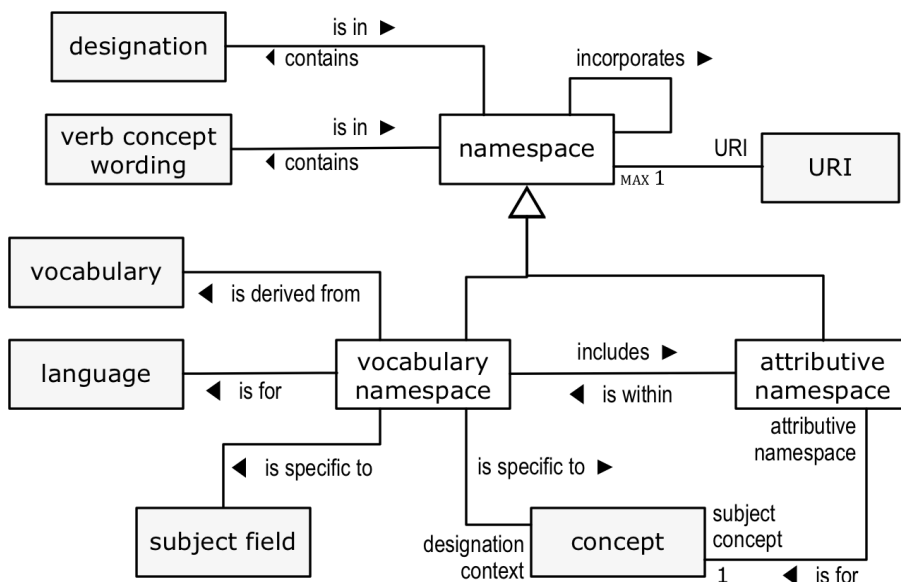

Figure 19.7 - Namespace and Kinds of Namespace

namespace

Definition: collection of [designations](#) and/or [verb concept wordings](#) that are distinguishable from each other by uniqueness of designator or form

Reference Scheme: a [URI of the namespace](#)

namespace₁ incorporates namespace₂

Definition: each [designation](#) and [verb concept wording](#) in the [namespace₂](#) is in the [namespace₁](#), and if the [namespace₁](#) is a [vocabulary namespace](#), each [attributive namespace](#) within the [vocabulary namespace₂](#) is incorporated into an [attributive namespace](#) in the [namespace₁](#) for the same [subject concept](#)

designation is in namespace

Definition: the namespace contains the designation such that the signifier of the designation is the signifier of no other designation in the namespace

Synonymous Form: namespace contains designation

verb concept wording is in namespace

Definition: the namespace contains the verb concept wording such that it is distinguishable from every other verb concept wording in the namespace

Synonymous Form: namespace contains verb concept wording

Note: The distinguishability of a verb concept wording from others within a namespace is based on how a use of the verb concept wording is recognized. Distinguishability considers positions of placeholders, meanings of designations used by placeholders and the expression of the verb concept wording excluding expressions of placeholders.

Example: The verb concept wording ‘proposition is true’ (with placeholder ‘proposition’) is indistinguishable from ‘[proposition] is true’ (with placeholder ‘[proposition]’) because both placeholders use a designation of the same concept (‘proposition’), but those two forms are distinguishable from ‘line is true’ (with placeholder ‘line’) because ‘proposition’ and ‘line’ designate different concepts.

namespace has URI

Definition: the URI uniquely identifies the namespace

Necessity: Each URI is the URI of at most one namespace.

19.5.2 Vocabulary Namespaces

vocabulary namespace

Definition: namespace that is derived from a vocabulary

vocabulary namespace is derived from vocabulary

Definition: the designations and verb concept wordings in the vocabulary namespace are from the vocabulary

Note: This specification does not require any particular process of derivation. But a typical process is that all designations and verb concept wordings that are directly distinguishable by their expressions are put into one vocabulary namespace. In the case of one or more designations or verb concept wordings being undistinguishable except by their subject fields, an additional vocabulary namespace is derived specifically for those subject fields.

vocabulary namespace is for language

Definition: each representation in the vocabulary namespace is for expression in the language

vocabulary namespace is specific to designation context

Definition: each designation and verb concept wording that is in the vocabulary namespace is in the designation context

vocabulary namespace is specific to subject field

Definition: each designation and verb concept wording that is in the vocabulary namespace is in the subject field

19.5.3 Attributive Namespaces

attributive namespace

- Definition: namespace that *contains* designations recognizable in the context of being attributed to instances of a particular concept
- Necessity: Each attributive namespace *is for* exactly one subject concept.
- Reference Scheme: a vocabulary namespace that *includes* the attributive namespace and the subject concept that *has* the attributive namespace
- Note: A designation in an attributive namespace typically represents a role of a binary verb concept. In English, such a designation can typically be used with any of several attributive forms, such as "... has ..." or "... of ...". A designation in an attributive namespace can also represent a characteristic. Different languages have different attributive forms - different grammatical structures relating a subject to something attributed to it.
- Example: Given an attributive namespace for the subject concept 'rental', a designation 'drop-off date' can be used in any of several attributive forms: "rental has drop-off date," "drop-off date of rental," "rental's drop-off date," "drop-off date is of rental," etc.
- Example: Given an attributive namespace for the subject concept 'rental', the designation 'assigned' for the characteristic 'rental is assigned' is recognized where it applies to a rental, as in "assigned rental."

attributive namespace is for subject concept

- Definition: the designations in the attributive namespace are for concepts attributable to instances of the subject concept
- Synonymous Form: concept has attributive namespace

attributive namespace is within vocabulary namespace

- Definition: the attributive namespace is a section of the vocabulary namespace attributable to the concept that has the attributive namespace
- Synonymous Form: vocabulary namespace includes attributive names

20 Adoption

20.1 Adoption of Definitions

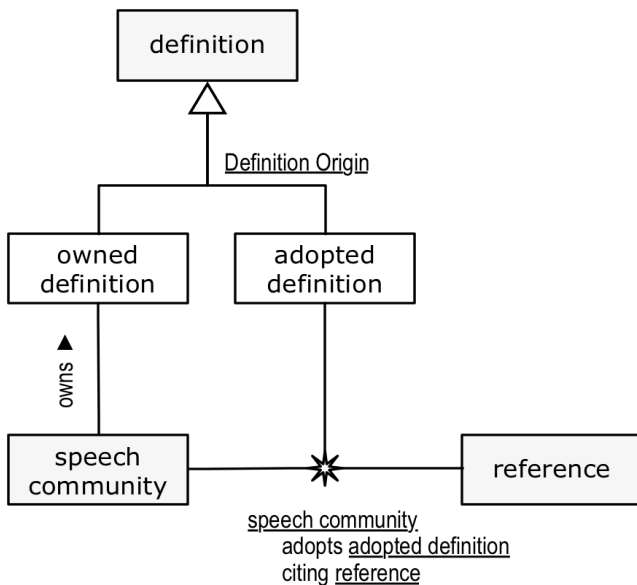

Figure 20.1 - Definition Adoption

Definition Origin

Definition: the categorization scheme of the concept 'definition' that classifies a definition based on whether it is owned by its speech community or adopted by its speech community

owned definition

Definition: definition that a speech community 'owns' and is responsible for creating and maintaining

Necessity: The concept 'owned definition' is included in Definition Origin.

Example: EU-Rent 'owns' its definition of the concept of 'barred driver'.

speech community owns owned definition

adopted definition

Definition: definition that a speech community adopts from an external source by providing a reference to the definition

Necessity: The concept 'adopted definition' is included in Definition Origin.

Necessity: Each adopted definition is always of a concept in the body of shared meanings that unites the semantic community that has the speech community.

Example: SBVR has adopted the concept 'concept' ('unit of knowledge created by a unique combination of characteristics') from ISO 1087-1 (English) (3.2.1).

- Note: By adopting the definition of ‘concept’, the SBVR community adopted the meaning of ‘concept’ as represented by the definition. A meaning cannot be adopted in the abstract; it is adopted via a representation of the meaning - a definition.
- A definition is expressed in some language, so is adopted by some speech community within the adopting semantic community.
- Adoption of the definition first adopted by a semantic community (via one of its speech communities) is the adoption of the concept.
- Example: Adoption of the definition of ‘concept’ from ISO 1087 by the English-speaking SBVR speech community.
- Note: Subsequent definitions of the adopted concept (e.g., in other natural languages) must have the same meaning as the first adopted definition.
- Example: Adoption of the definition of ‘concept’ (‘unité de connaissance créée par une combinaison unique de caractères’) from ISO 1087 by the French-speaking SBVR speech community.
- Note: The primary term used for the concept does not have to be the same as the primary term in the source.
- Example: SBVR has adopted the definition of ‘object’ from ISO 1087, but uses the term ‘thing’ to designate it.
- Example: The French-speaking SBVR speech community might choose to use the synonym ‘notion’ (also used in ISO 1087) instead of ‘concept’.
- Note: When an adopted concept is designated by a preferred term or verb symbol different from the one in the source, related adopted definitions may be localized with these preferred designations while retaining their meanings.
- Example: SBVR has adopted the definition of ‘individual noun concept’ (‘concept that corresponds to only one object’) from ISO 1087 but, using its preferred term ‘thing’ instead of ‘object’, has localized it as ‘concept that corresponds to only one thing’.
- Note: When a concept’s definition is adopted, all other concepts in the referenced source that are used in the definition are also adopted. These adoptions may be explicit in the adopting speech community’s vocabulary or implicit within the source vocabulary.

speech community adopts adopted definition citing reference

- Definition: **the speech community** agrees that **the definition** identified by **the reference** can serve as **the adopted definition**
- Note: The reference is the name of the source and the designation used in the source with, if available, informally-styled referencing within the source - ‘(3.2.1)’ in the example below.
- Example: [ISO 1087-1 \(English\)](#) (3.2.1) [‘concept’]

20.2 Adoption of Business Rules

Elements of guidance may be adopted from external authorities. These external authorities might be membership-based associations for certain industries (e.g., finance, healthcare, telecommunications), for certain professional practices (e.g., accountancy, law, human resources), or for certain domain expertise (e.g., biofuels, photography, software engineering). If elements of guidance are adopted, the concepts – noun concepts and verb concepts – used in defining the elements of guidance must be included in the body of shared concepts of the adopting authority. This usually means that the concepts have been adopted from, or defined in collaboration with, the providing authority that is the source of the adopted elements of guidance.

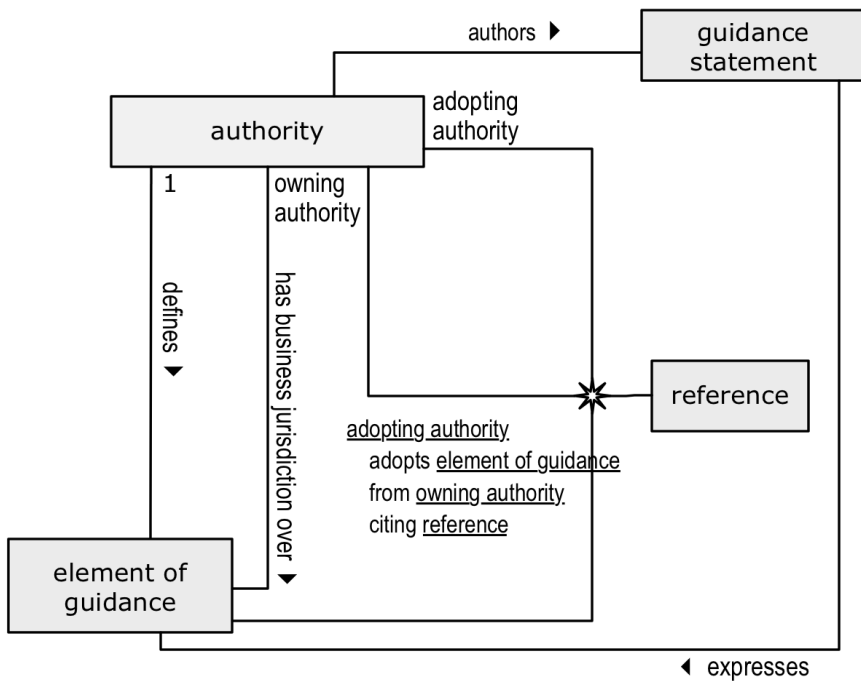

Figure 20.2 - Element of Guidance Adoption

authority authors guidance statement

Definition: the authority authors a guidance statement that expresses some element of guidance

Note: An authority may author guidance statements for adopted elements of guidance as well as for elements of guidance it defines.

authority defines element of guidance

Definition: the authority authors the first guidance statement that expresses the element of guidance

Necessity: Each element of guidance is defined by exactly one authority.

adopting authority

Concept Type: role

Definition: authority that adopts some element of guidance

owning authority

Concept Type: role

Definition: authority that has business jurisdiction over some element of guidance

adopting authority adopts element of guidance from owning authority citing reference

Definition: the authority adopts the element of guidance from the owning authority citing a reference that points to a guidance statement that expresses the element of guidance

- Necessity: The reference that is cited by an owning authority that adopts an element of guidance from an owning authority points to a guidance statement that expresses the element of guidance and that is included in a rulebook that is determined by a speech community of the owning authority
- Note: An element of guidance cannot be adopted in the abstract; it is adopted via a representation of the meaning - a guidance statement
- Note: Subsequent guidance statements of the adopted element of guidance (e.g., in other natural languages) must have the same meaning as the first adopted guidance statement.
- Note: When a guidance statement is adopted, all concepts in the referenced source that are used in the guidance statement are also adopted. These adoptions may be explicit in the adopting authority's vocabulary, or implicit, within the source vocabulary.
- Note: The primary guidance statement used for the element of guidance does not have to be the same as the primary guidance statement in the source. Concepts used in the element of guidance should be represented by their preferred terms and verb symbols in the adopting body of shared guidance.
- Example: EU-Rent has adopted an behavioral business rule from from an industry glossary: "Before handover of a rented car, the rental contract must be signed by the customer responsible for the rental". EU-Rent uses its own preferred terms, 'rental contract document' and 'renter' for its primary guidance statement: "The rental contract document of a rental must be signed by the renter of the rental before handover of the rented car of the rental".

21 Logical Formulation of Semantics

21.1 General

The vocabulary in this clause is not intended for use by business people in general, but rather, it is a vocabulary used to describe the formal semantic structures of business discourse. It is not for discussing business, but for discussing the semantic structures underlying business communications of concepts, propositions and questions. For example, a typical business person does not tend to talk about quantifications, but he expresses quantifications in almost every statement he makes. He doesn't tend to talk about conjunctions, disjunctions, logical negations, antecedents and consequents, but these are all part of the formulation of his thinking. The vocabulary in this clause is for talking about these conceptual devices that people use all the time.

Semantic formulations are not representations or expressions of meaning. Rather, they are structures of meaning – the logical composition of meaning.

Business rules are generally expressed in natural language, although some rules are at times illustrated graphically. SBVR does not provide a logic language for restating business rules in some other language that business people don't use. Rather, SBVR provides a means for describing the structure of the meaning of rules expressed in the natural language that business people use. Semantic formulations are not expressions or statements. They are structures that make up meaning. Using SBVR, the meaning of a definition or statement is communicated as facts about the semantic formulation of the meaning, not as a restatement of the meaning in a formal language.

There are two kinds of semantic formulations. The first kind, logical formulation, structures propositions, both simple and complex. Specializations of that kind are given for various logical operations, quantifications, atomic formulations based on verb concepts and other formulations for special purposes such as objectifications and nominalizations.

The second kind of semantic formulation is projection. It structures intensions as sets of things that satisfy constraints. Projections formulate definitions, aggregations, and questions.

Semantic formulations are recursive. Several kinds of semantic formulations embed other semantic formulations. Logic variables are introduced by quantifications (a kind of logical formulation) and projections so that embedded formulations can refer to instances of concepts. A logic variable used in a formulation is free within that formulation if it is not introduced within that formulation. A formulation is closed if no variable is free within it. Only a closed semantic formulation can formulate a meaning. If a formulation has a variable that is free within it, then it can be part of a larger formulation of a meaning (one that introduces the variable) but it does not by itself formulate a meaning.

The hierarchical composition of semantic formulations is seen in the following example of a very simple business rule. The rule is stated in different ways but is one rule having one meaning. Many other statements are possible.

- A rental must have at most three additional drivers.
- It is obligatory that each rental has at most three additional drivers.

Below is a representation of a semantic formulation of the rule above as sentences that convey the full structure of the rule. Note that different semantic formulations are possible for the same meaning. Two semantic formulations can be determined to have the same meaning either by logical analysis or by assertion (as a matter of definition). A single formulation is shown below.

- . The rule is a proposition meant by an obligation formulation.
- . . That obligation formulation embeds a universal quantification.
- . . . The universal quantification introduces a first variable.
- The first variable ranges over the concept 'rental'.

- . . The universal quantification scopes over an at-most-n quantification.
- . . . The at-most-n quantification has the maximum cardinality 3.
- . . . The at-most-n quantification introduces a second variable.
- The second variable ranges over the concept ‘additional driver’.
- . . . The at-most-n quantification scopes over an atomic formulation.
- The atomic formulation is based on the verb concept ‘rental has additional driver’.
- The atomic formulation has a role binding.
- The role binding is of the role ‘rental’ of the verb concept.
- The role binding binds to the first variable.
- The atomic formulation has a second role binding.
- The second role binding is of the role ‘additional driver’ of the verb concept.
- The second role binding binds to the second variable.

Note that designations like ‘rental’ and ‘additional driver’ represent concepts. The semantic formulations involve the concepts themselves, so identifying the concept ‘rental’ by another designation (such as from another language) does not change the formulation.

The indentation in the example shows a hierarchical structure in which a semantic formulation at one level operates on, applies a modality to, or quantifies over one or more semantic formulations at the next lower level. Each kind of logical formulation, including modal formulations, quantifications, and logical operations, can be embedded in other semantic formulations to any depth and in almost any combination.

Within the one atomic formulation in the example are bindings to two variables. The variables are free within the atomic formulation because they are introduced outside of it (higher in the hierarchical structure). For this reason, the atomic formulation has no meaning. But the obligation formulation has a meaning (the rule) and so does the universal quantification within the obligation formulation because both are closed.

Semantic formulations are further exemplified for a simple definition of a characteristic, “driver is of age.”

Definition: the age of the driver is at least the EU-Rent Minimum Driving Age

Below is a representation of a semantic formulation of the definition. Note that different semantic formulations are possible. A single formulation is shown below.

- The characteristic is defined by a projection.
- . The projection is on a first variable.
- . . The first variable ranges over the concept ‘driver’.
- . . The first variable maps to the one role of the characteristic.
- . The projection is constrained by a first universal quantification.
- . . The first universal quantification introduces a second variable.
- . . . The second variable ranges over the concept ‘age’.
- . . . The second variable is unitary.
- . . . The second variable is restricted by an atomic formulation.
- The atomic formulation is based on the verb concept ‘driver has age’.
- The atomic formulation has a role binding.
- The role binding is of the role ‘driver’ of the verb concept.
- The role binding binds to the first variable.
- The atomic formulation has a second role binding.
- The second role binding is of the role ‘age’ of the verb concept.
- The second role binding binds to the second variable.

- . . The first universal quantification scopes over a second universal quantification.
- . . . The second universal quantification introduces a third variable.
- The third variable ranges over the concept ‘EU-Rent Minimum Driving Age’.
- The third variable is unitary.
- . . . The second universal quantification scopes over an atomic formulation.
- The atomic formulation is based on the verb concept ‘quantity₁ ≥ quantity₂’.
- The atomic formulation has a role binding.
- The role binding is of the role ‘quantity₁’ of the verb concept.
- The role binding binds to the second variable.
- The atomic formulation has a second role binding.
- The second role binding is of the role ‘quantity₂’ of the verb concept.
- The second role binding binds to the third variable.

The projection that defines the characteristic is on a single variable. A projection defining a binary verb concept is on two variables, one mapped to each role. Note that the definition of the characteristic above uses two binary verb concepts, but all of the roles of those verb concepts are bound to variables introduced by the projection or by formulations within in, so the projection is closed and conveys a meaning.

SBVR does not attempt to provide special semantic formulations for tenses or the variety of ways states and events can relate to each other with respect to time or can be related to times, periods, and durations. However, an objectification is a logical formulation that enables a state or event indicated propositionally to be the subject or object of other propositions. An encompassing formulation can relate a state or event indicated using an objectification to points in time, periods, and durations, or to another state or event (possibly also identified using an objectification) with respect to time (e.g., occurring after or occurring before). The specific relations of interest can be defined as verb concepts. SBVR’s treatment of time in relation to states and events allows temporal relations to be defined generically and orthogonally to the many verb concepts whose extensions change over time.

A propositional nominalization is similar to an objectification. It is a kind of logical formulation that structures the meaning represented by a mention of a statement or proposition as opposed to a use of it. Other similar types of formulations structure meanings represented by mention of concepts, questions, and answers. Furthermore, rules about change often involve noun concept nominalizations, which are special formulations that allow a concept to be a subject or object of a proposition in much the same way that proposition nominalization allows a proposition to be a subject or object.

Semantic formulations are structures, and as such, are identified structurally as finite directed graphs. The reference schemes for semantic formulations and their parts take into account their entire structure. In some cases, a transitive closure of a reference scheme shows partial loops (partial in the sense that only a part of a reference scheme loops back, never all of it). This approach allows parts of a closed formulation to be identified by what it is in its particular context while, at the same time, contributing to the unique identity of the formulation that contains it.

21.2 Semantic Formulations

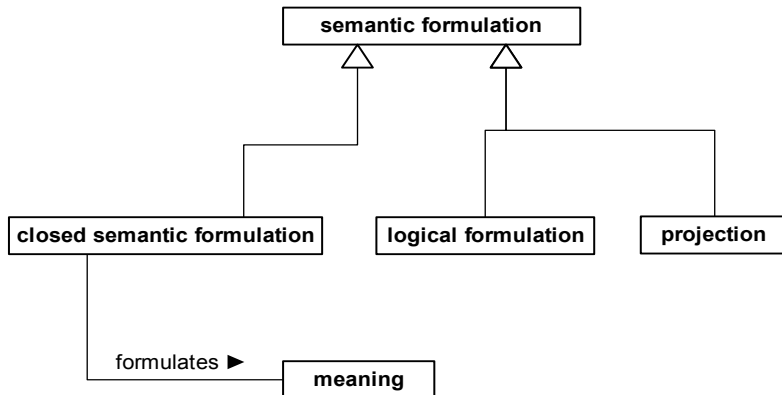

Figure 21.1

This diagram shows the SBVR terminological entries of this sub clause as explained in Annex C.

semantic formulation

FL

Definition: conceptual structure of meaning

Note: The definitions of several specializations of ‘semantic formulation’ explain what meaning is formulated. A meaning is directly formulated only for a closed semantic formulation. In the case of variables being free within a semantic formulation, a meaning is formulated with respect there being exactly one referent thing given for each free variable.

closed semantic formulation

FL

Definition: semantic formulation that *includes no variable without binding*

closed semantic formulation formulates meaning

Definition: the meaning is structured by the closed semantic formulation

21.3 Logical Formulations

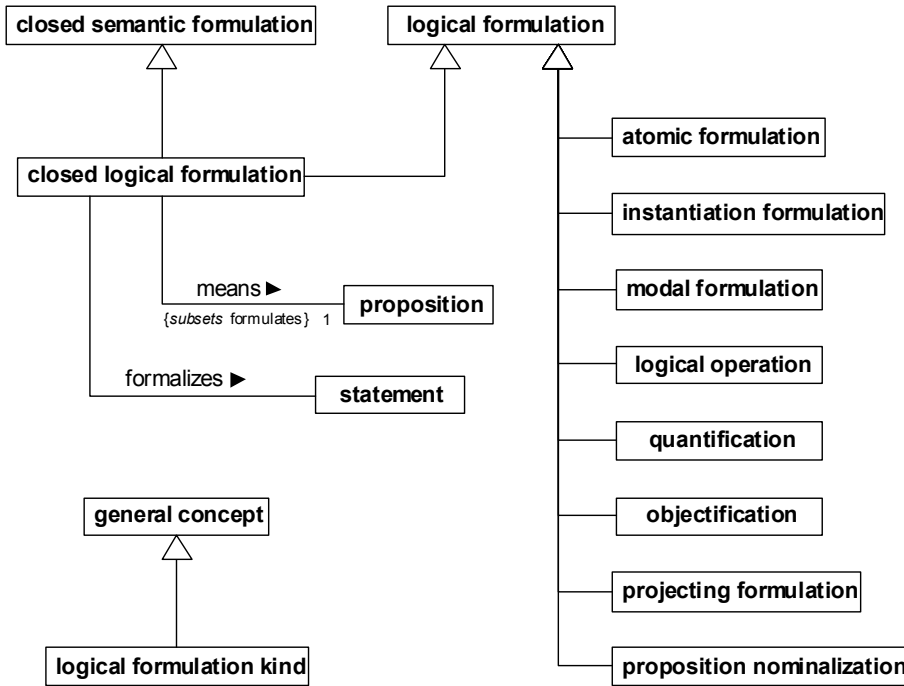

Figure 21.2

This diagram shows the SBVR terminological entries of this sub clause as explained in Annex C.

logical formulation

FL

Definition: [semantic formulation](#) that formulates a proposition

Necessity: Each [logical formulation](#) is an instance of exactly one [logical formulation kind](#).

logical formulation kind

FL

Definition: [general concept](#) that specializes the concept 'logical formulation' and that classifies a [logical formulation](#) based on the presence or absence of a main logical operation or quantification

Note: The absence of a main logical operator occurs for an [atomic formulation](#) or [instantiation formulation](#).

Example: [logical negation](#), [conjunction](#), [universal quantification](#)

closed logical formulation

FL

Definition: [logical formulation](#) that is a [closed semantic formulation](#)

Necessity: Each [meaning formulated by a closed logical formulation](#) is a [proposition](#).

Necessity: Each [closed logical formulation](#) means exactly one [proposition](#).

Necessity: Each [closed logical formulation](#) that formalizes a [statement](#) means the [proposition](#) that is expressed by the [statement](#).

closed logical formulation means proposition

FL

Definition: the closed logical formulation *formulates* the proposition

closed logical formulation formalizes statement

FL

Definition: the closed logical formulation *means* the proposition that *is expressed by the statement* and the closed logical formulation refers to the concepts represented in the statement

Example: If ‘barred driver’ is defined as “person that must not drive a car,” then the statements “Ralph is a barred Driver” and “Ralph is a person that must not drive a car” express the same proposition. But those two statements are formalized differently: one in reference to ‘barred driver’ and the other in reference to ‘person’, ‘car’, and ‘person drives car’. The two formulations are different but mean the same proposition.

21.3.1 Variables and Bindings

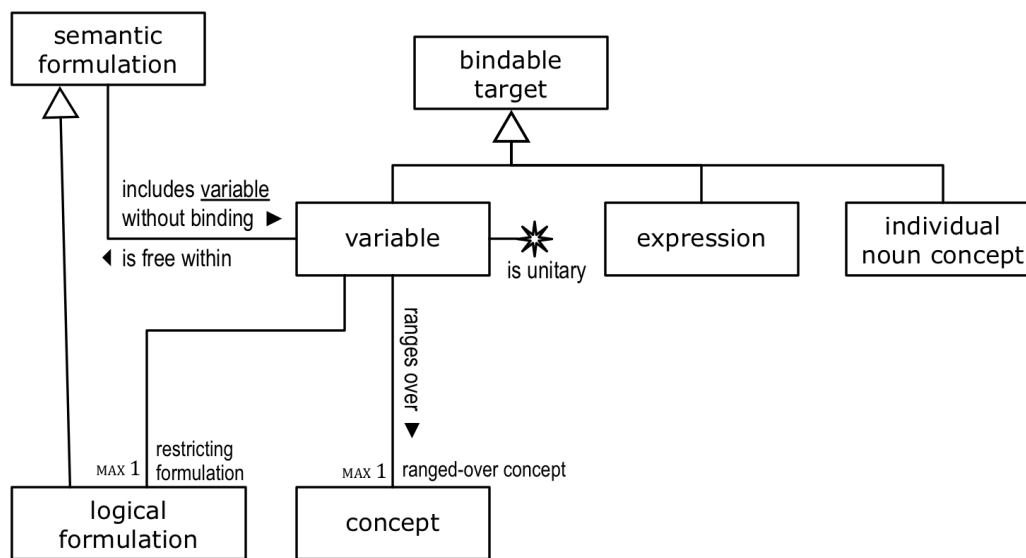

Figure 21.3

This diagram shows the SBVR terminological entries of this sub clause as explained in Annex C.

variable

FL

Definition: reference to an element of a set, whose referent may vary or is unknown

Note: The set of referents of a variable is defined by the two verb concepts ‘variable ranges over concept’ and ‘logical formulation restricts variable’. The set is limited to instances of the concept, if given. If the variable is restricted by a logical formulation, the set is further limited to those things for which the meaning formulated by that logical formulation is true when the thing is substituted for each occurrence of the variable in the formulation. If there is no concept and no restricting logical formulation the set includes every thing.

Necessity: Each variable ranges over at most one concept.

Necessity: Each variable is restricted by at most one logical formulation.

Reference Scheme: a quantification that *introduces* the variable and the set of concepts that *are ranged over by* the variable and the set of logical formulations that *restrict* the variable and whether the variable is unitary

Reference Scheme: a projection that *is on* the variable and a projection position of the variable and the set of concepts that *are ranged over by* the variable and the set of logical formulations that *restrict* the variable and whether the variable is unitary.

variable ranges over concept

FL

Definition: each referent of the variable is an instance of the concept

Synonymous Form: variable has ranged-over concept

logical formulation restricts variable

Definition: for each referent of the variable, the meaning formulated by the logical formulation is true when the referent is substituted for each occurrence of the variable in the logical formulation

Synonymous Form: variable has restricting formulation

Note: The meaning of the logical formulation is true for every actual referent of the variable. The things for which the meaning of the logical formulation is false are not considered to be referents of the variable.

Note: A logical formulation restricts a variable in the same way that a concept ranged over by the variable restricts the variable. It limits what the variable refers to. A restrictive clause in a statement is generally formulated as a logical formulation that restricts a variable. A variable restricted by a logical formulation is, except in rare cases, a free variable of the logical formulation.

Example: “Each rental car that is inoperable is unavailable.” In the formulation below, a variable ranges over the concept ‘rental car’ and is restricted by an atomic formulation based on the verb concept ‘vehicle is inoperable’. Referents of the variable are thereby restricted to being rental cars and to being vehicles that are inoperable.

Example: The proposition is meant by a universal quantification.
 . The universal quantification introduces a variable.
 . . The variable ranges over the concept ‘rental car’.
 . . The variable is restricted by an atomic formulation.
 . . . The atomic formulation is based on the verb concept ‘vehicle is inoperable’.
 The ‘vehicle’ role is bound to the variable.
 . The universal quantification scopes over an atomic formulation.
 . . The atomic formulation is based on the verb concept ‘rental car is unavailable’.
 . . . The ‘rental car’ role is bound to the variable.

variable is unitary

FL

Definition: the variable is meant to have exactly one referent in the context where the variable is introduced

Note: This characteristic is used particularly in the formulation of definite descriptions.

If a set projection is on one variable and that variable is unitary, then the projection is meant to have exactly one result. For any other projection on a unitary variable, the projection is meant to have one referent for that variable for each combination of referents of other variables (including auxiliary variables) in the same projection.

If a unitary variable is introduced by a universal quantification, the variable ranges over a concept and is restricted by a logical formulation, then the quantification is satisfied if:

1. the unitary variable has exactly one referent, an instance of the concept, for which the restricting logical formulation is satisfied.
2. the logical formulation that the universal quantification scopes over is also satisfied for that one referent.

An exactly-one quantification introducing a non-unitary variable is satisfied differently:

1. the variable has at least one referent, an instance of the concept, for which the restricting logical formulation is satisfied.
2. the logical formulation that the exactly-one quantification scopes over is satisfied for exactly one referent from 1 above.

Example:

Given the individual noun concept ‘London-Heathrow Branch’ defined as “the EU-Rent branch located at London-Heathrow Airport,” the definition can be formulated as a projection on a variable that ranges over the concept ‘EU-Rent branch’. The variable is unitary indicating the sense of the definite article “the.” Based on this formulation, the concept ‘London-Heathrow Branch’ is understood to be an individual noun concept. If the variable is not made unitary, then the formulation captures only the characteristic of being located at London-Heathrow Airport without any indication of the intended meaning that there is exactly one such branch.

Example:

A sensible projection formulating “the renter of a given rental” is on a unitary variable (renter) and has an auxiliary variable (rental). The rental variable being unitary indicates there is exactly one renter for each rental. But a set projection formulating “renter of at least one rental” is not on a unitary variable because the variable for rental is introduced within the logical formulation that constrains the projection and not by the projection itself. The projection result can include multiple renters and does not relate these to particular rentals.

Example:

A possible formulation of the rule, “The pick-up location of each rental must be a EU-Rent branch,” has a variable for ‘pick-up location’ that is unitary with respect to each rental as indicated by the use of the definite article “the.” The possible formulation is an obligation formulation that embeds a universal quantification introducing a variable ranging over the concept “rental” and that embeds a second universal quantification introducing a second variable which is restricted by an atomic formulation based on the verb concept ‘rental has pick-up location’. That second variable is unitary indicating that exactly one pick-up location is meant for each rental. The second universal quantification scopes over a formulation of the pick-up location being a EU-Rent branch. The overall formulation applies the obligation formulation to the pick-up location being a EU-Rent branch. It does not apply the obligation formulation to there being one pick-up branch per rental, which is understood definitionally as what is meant in the expression of the rule and not part of the obligation.

Note that if the universal quantifications of the formulation above are reversed such that a quantification introducing the variable for ‘pick-up location’ embeds the quantification introducing the variable for ‘rental’, then the variable for ‘pick-up rental’ is not unitary because it would have multiple referents (one for each distinct pick-up location). Such a formulation would not properly capture the sense of the rule statement.

variable is free within semantic formulation

FL

Definition: **the semantic formulation** employs **the variable**, but does not introduce it

Synonymous Form: [semantic formulation](#) *includes* [variable](#) *without binding*

bindable target

FL

Definition: [variable](#), [expression](#) or [individual noun concept](#)



Note: The meaning of binding to a variable from a logical formulation, such as an atomic formulation, is that a referent of the variable is the thing involved in or considered by the formulation.

Note: The meaning of binding to an individual noun concept from a logical formulation is that the formulation refers to the one instance of the individual noun concept. A difference between binding to an individual noun concept and binding to a variable that ranges over the individual noun concept is that a variable can be further restricted by a logical formulation giving it the possibility of referring to nothing.

Note: The meaning of binding to an expression (such as a text or graphic) from a logical formulation is that the formulation refers to the expression itself without regard to any meaning the expression might have.

Example: “The text ‘EU-Rent’ is inscribed on each EU-Rent vehicle.” A logical formulation of this proposition involves a binding to the text “EU-Rent,” which simply refers to that expression, not to the individual noun concept ‘EU-Rent’ nor to any representation of it. The logical formulation also involves a binding to a variable that ranges over the concept ‘EU-Rent vehicle’.

The proposition is meant by a universal quantification.
. The universal quantification introduces a variable.
. . The variable ranges over the concept ‘EU-Rent vehicle’.
. The universal quantification scopes over an atomic formulation.
. . The atomic formulation is based on the verb concept
 ‘[expression](#) is inscribed on [object](#)’.
. . . The ‘[expression](#)’ role is bound to the text “EU-Rent.”
. . . The ‘[object](#)’ role is bound to the variable

Example: “The logo  is inscribed on each EU-Rent vehicle.” This example is the same as the one above except that the ‘expression’ role is bound to the logo .

21.3.2 Atomic Formulations

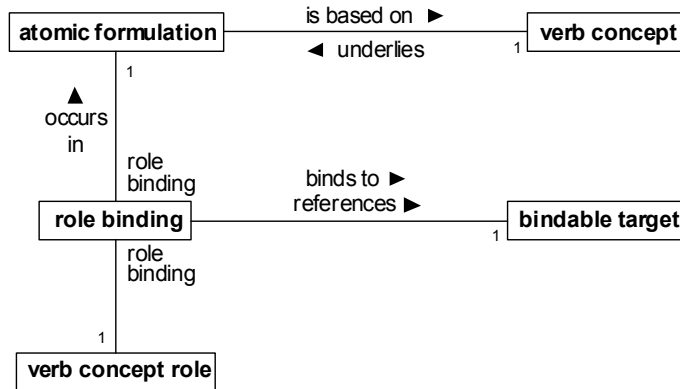

Figure 21.4

This diagram shows the SBVR terminological entries of this sub clause as explained in Annex C.

atomic formulation

FL

Definition:

logical formulation that is based on a **verb concept** and that has a **role binding** of each **role** of the **verb concept** and that formulates the meaning: there is an **actuality** that involves in each **role** of the **verb concept** the thing to which the **bindable target** of the corresponding **role binding** refers

Concept Type:

logical formulation kind

Necessity:

Each **atomic formulation** is based on exactly one **verb concept**.

Reference Scheme:

the set of **role bindings of the atomic formulation**

Note:

The meaning invoked by an atomic formulation puts each referent of each role binding in its respective verb concept role. Where a verb concept role ranges over some general concept, that meaning implies (as a separate secondary meaning) that the referent of the role binding for that role is an instance of the general concept.

Example:

“EU-Rent purchases from General Motors Company.”

The statement is formulated by an atomic formulation.

. The atomic formulation is based on the verb concept ‘**company** purchases from **vendor**’.

. The atomic formulation has a first role binding.

.. The first role binding is of the role ‘**company**’ of the verb concept.

.. The first role binding binds to the individual noun concept ‘EU-Rent’.

. The atomic formulation has a second role binding.

.. The second role binding is of the role ‘**vendor**’ of the verb concept.

.. The second role binding binds to the individual noun concept ‘General Motors Company’.

atomic formulation has role binding

FL

Definition:

the **atomic formulation** includes the **role binding** for a particular **role** of the **verb concept** that is the basis of the **atomic formulation**

Synonymous Form:

role binding occurs in atomic formulation

Necessity: Each variable that *is bound to an instantiation formulation* is free within the instantiation formulation.

Reference Scheme: the bindable target that *is bound to the instantiation formulation* and the concept that *is considered by the instantiation formulation*

Note: An instantiation formulation is equivalent to an existential quantification that introduces a variable ranging over the concept considered by the instantiation formulation and that scopes over an atomic formulation based on the verb concept 'thing is thing' where one role binding is to the variable and the other is to the bindable target bound to the instantiation formulation.

Example: "EU-Rent is a car rental company."
 The statement is formulated by an instantiation formulation.
 . The instantiation formulation considers the concept "car rental company".
 . The instantiation formulation binds to the individual noun concept 'EU-Rent'.

instantiation formulation considers concept

FL

Definition: the instantiation formulation classifies things to be an instance of the concept

instantiation formulation binds to bindable target

FL

Definition: the bindable target indicates what thing is being classified by the instantiation formulation

Synonymous Form: bindable target is bound to instantiation formulation

21.3.4 Modal Formulations

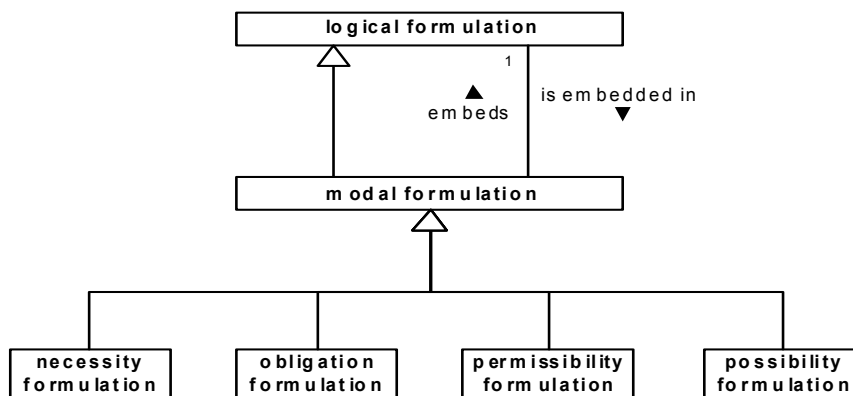

Figure 21.6

This diagram shows the SBVR terminological entries of this sub clause as explained in Annex C.

modal formulation

FL

Definition: logical formulation that formulates that the meaning of another logical formulation has a particular relationship to possible worlds or to acceptable worlds

Necessity: Each modal formulation *embeds exactly one* logical formulation.

Necessity: Each variable that *is free within a logical formulation* that *is embedded in a modal formulation* is free within the modal formulation.

Example: “EU-Rent may purchase from General Motors Company.” The statement is formulated by a permissibility formulation (a kind of modal formulation) that embeds the entire formulation shown in the previous sub clause in the example under ‘atomic formulation’ - the formulation of “EU-Rent purchases from General Motors Company.” The meaning of the permissibility formulation is that EU-Rent purchases from General Motors Company in some possible world.

modal formulation embeds logical formulation

FL

Definition: **the modal formulation** formulates that the meaning of **the logical formulation** has a particular relationship to possible worlds or to acceptable worlds

Synonymous Form: **logical formulation is embedded in modal formulation**

necessity formulation

FL

Definition: **modal formulation that** formulates that the meaning of its embedded **logical formulation** is true in all possible worlds

Concept Type: **logical formulation kind**

Reference Scheme: **the logical formulation that is embedded in the necessity formulation**

obligation formulation

FL

Definition: **modal formulation that** formulates that the meaning of its embedded **logical formulation** is true in all acceptable worlds

Concept Type: **logical formulation kind**

Reference Scheme: **the logical formulation that is embedded in the obligation formulation**

Example: A rental may be open only if an estimated rental charge is provisionally charged for the rental". The same rule can be stated this way: “It is prohibited that a rental is open if an estimated rental charge is not provisionally charged for the rental.” Both statements can be formulated in the same way:

The rule is a proposition meant by an obligation formulation.

. The obligation formulation embeds a logical negation

.. The logical operand of the logical negation is a universal quantification.

... The universal quantification introduces a first variable.

.... The first variable ranges over the concept ‘rental’.

... The universal quantification scopes over an implication.

.... The consequent of the implication is an atomic formulation.

..... The atomic formulation is based on the verb concept ‘rental is open’.

..... The ‘rental’ role is bound to the first variable.

.... The antecedent of the implication is an existential quantification.

..... The existential quantification introduces a second variable.

..... The second variable ranges over the concept ‘estimated rental charge’.

..... The existential quantification scopes over a logical negation.

..... The logical operand of the logical negation is an atomic formulation.

..... The atomic formulation is based on the verb concept

‘estimated rental charge is provisionally charged for rental’.

..... The ‘estimated rental charge’ role is bound to the second variable.

..... The ‘rental’ role is bound to the first variable.

permissibility formulation

FL

- Definition: modal formulation that formulates that the meaning of its embedded logical formulation is *permitted to be true*
- Concept Type: logical formulation kind
- Reference Scheme: *the* logical formulation *that is embedded in the* permissibility formulation

possibility formulation

FL

- Definition: modal formulation that formulates that the meaning of its embedded logical formulation is true in some possible world
- Concept Type: logical formulation kind
- Reference Scheme: *the* logical formulation *that is embedded in the* possibility formulation

21.3.5 Logical Operations

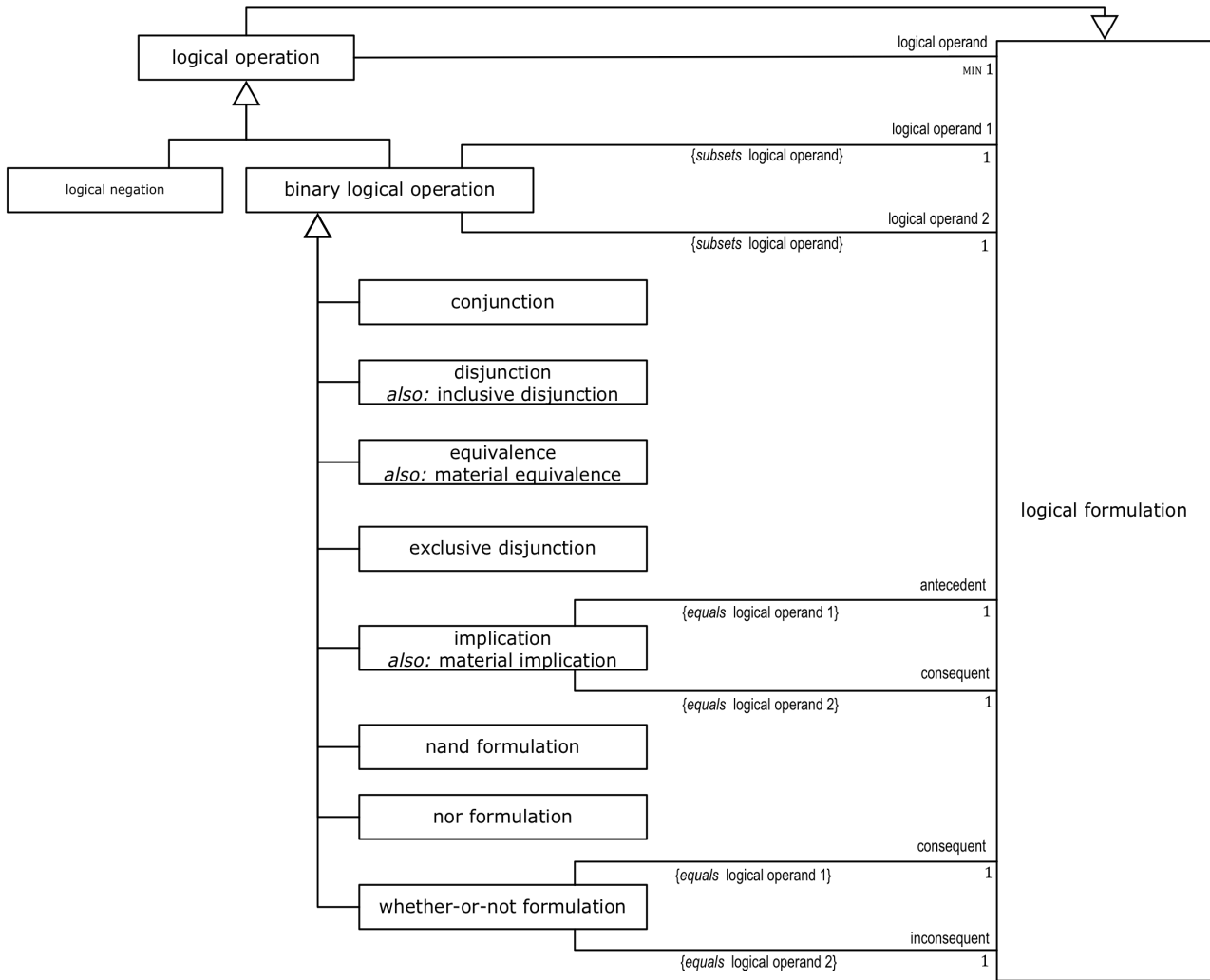

Figure 21.7

This diagram shows the SBVR terminological entries of this sub clause as explained in Annex C.

logical operation

FL

Definition: [logical formulation](#) that formulates a meaning based on only the truth or falseness of the meanings of one or more other logical formulations (its [logical operands](#))

Necessity: Each [logical operation](#) has at least one [logical operand](#).

Necessity: Each [variable](#) that is free within a [logical operand](#) of a [logical operation](#) is free within the [logical operation](#).

logical operand

FL

Definition: [logical formulation](#) upon which a given [logical operation](#) operates
Concept Type: [role](#)

logical operation has logical operand

FL

Definition: [the logical operation](#) operates on [the logical operand](#)

binary logical operation

FL

Definition: [logical operation](#) [that](#) operates on two [logical operands](#)
Necessity: [Each binary logical operation has exactly one logical operand 1.](#)
Necessity: [Each binary logical operation has exactly one logical operand 2.](#)
Note: Distinct roles are defined for the two operands of a binary logical operation even though there is no significant difference between the roles for some operations, such as for conjunction. The one distinction that remains, however, is that the roles are distinct from each other, and this distinction is important where an operation has the same logical formulation filling both roles, such as in ‘*p* and *p*’ or ‘*p* if and only if *p*’.

logical operand 1

FL

Definition: [logical operand](#) [that](#) is the first of at least two operands to a [logical operation](#)
Definition: [role](#)
Necessity: [Each logical operation has at most one logical operand 1.](#)

logical operand 2

FL

Definition: [logical operand](#) [that](#) is the second of at least two operands to a [logical operation](#)
Concept Type: [role](#)
Necessity: [Each logical operation has at most one logical operand 2.](#)

binary logical operation has logical operand 1

FL

Definition: [the binary logical operation](#) operates on [the logical operand 1](#)

binary logical operation has logical operand 2

FL

Definition: [the binary logical operation](#) operates on [the logical operand 2](#)

conjunction

FL

Definition: [binary logical operation](#) [that](#) formulates that the meaning of each of its [logical operands](#) is true
Concept Type: [logical formulation kind](#)
Reference Scheme: [the logical operand 1 of the conjunction and the logical operand 2 of the conjunction.](#)

disjunction

FL

Definition: [binary logical operation](#) [that](#) formulates that the meaning of at least one of its [logical operands](#) is true
Concept Type: [logical formulation kind](#)
Synonym: [inclusive disjunction](#)
Reference Scheme: [the logical operand 1 of the disjunction and the logical operand 2 of the disjunction](#)

equivalence

FL

- Definition: [binary logical operation](#) that formulates that the meaning of its [logical operands](#) are either all true or all false
- Concept Type: [logical formulation kind](#)
- Synonym: [material equivalence](#)
- Reference Scheme: [the logical operand 1 of the equivalence](#) and [the logical operand 2 of the equivalence](#)

exclusive disjunction

FL

- Definition: [binary logical operation](#) that formulates that the meaning of one [logical operand](#) is true and the meaning of the other [logical operand](#) is false
- Concept Type: [logical formulation kind](#)
- Reference Scheme: [the logical operand 1 of the exclusive disjunction](#) and [the logical operand 2 of the exclusive disjunction](#)

implication

FL

- Definition: [binary logical operation](#) that operates on an [antecedent](#) and a [consequent](#) and that formulates that the meaning of the [consequent](#) is true if the meaning of the [antecedent](#) is true
- Concept Type: [logical formulation kind](#)
- Synonym: [material implication](#)
- Necessity: [Each implication has exactly one antecedent.](#)
- Necessity: [Each implication has exactly one consequent.](#)
- Reference Scheme: [the antecedent of the implication](#) and [the consequent of the implication](#)

antecedent

FL

- Definition: [logical operand](#) that is the condition considered by a [logical operation](#) such as an [implication](#) (e.g., what is meant by the p in “if p then q ”)
- Concept Type: [role](#)

consequent

FL

- Definition: [logical operand](#) that is the implied or result operand to a [logical operation](#) such as an [implication](#) (e.g., what is meant by the q in “if p then q ”)
- Concept Type: [role](#)

implication has antecedent

FL

- Definition: [the antecedent is the logical operand 1 of the implication](#)

implication has consequent

FL

- Definition: [the consequent is the logical operand 2 of the implication](#)

logical negation

FL

- Definition: [logical operation](#) that has exactly one [logical operand](#) and that formulates that the meaning of the [logical operand](#) is false
- Concept Type: [logical formulation kind](#)
- Necessity: [Each logical negation has exactly one logical operand.](#)
- Reference Scheme: [the logical operand of the logical negation](#)

nand formulation

FL

- Definition: [binary logical operation](#) that formulates that the meaning of at least one of its [logical operands](#) is false
- Concept Type: [logical formulation kind](#)
- Reference Scheme: [the logical operand 1 of the nand formulation](#) and [the logical operand 2 of the nand formulation](#)

nor formulation

FL

- Definition: [binary logical operation](#) that formulates that the meaning of each of its [logical operands](#) is false
- Concept Type: [logical formulation kind](#)
- Reference Scheme: [the logical operand 1 of the nor formulation](#) and [the logical operand 2 of the nor formulation](#)

whether-or-not formulation

FL

- Definition: [binary logical operation](#) that has a [consequent](#) and an [inconsequent](#) and that formulates that the meaning the [consequent](#) is true regardless of the meaning the [inconsequent](#)
- Concept Type: [logical formulation kind](#)
- Necessity: [Each whether-or-not formulation has exactly one consequent.](#)
- Necessity: [Each whether-or-not formulation has exactly one inconsequent.](#)
- Reference Scheme: [the consequent of the whether-or-not formulation](#) and [the inconsequent of the whether-or-not formulation](#)

inconsequent

FL

- Definition: [logical operand](#) that is an operand irrelevant to the logical result of a [logical operation](#) such as of a [whether-or-not formulation](#)
- Concept Type: [role](#)

whether-or-not formulation has consequent

FL

- Definition: [the consequent is the logical operand 1 of the whether-or-not formulation](#)

whether-or-not formulation has inconsequent

FL

- Definition: [the inconsequent is the logical operand 2 of the whether-or-not formulation](#)

quantification

FL

- Definition: logical formulation that introduces a variable and that has either the meaning: all referents of the variable satisfy a scope formulation; or the meaning: a bounded number of referents of the variable exist and satisfy a scope formulation, if there is one
- Note: A referent of the introduced variable satisfies a scope formulation if the meaning formulated by the scope formulation is true with every occurrence of the variable interpreted as referring to the referent.
- Note: If a quantification scopes over no logical formulation, the meaning is that the bounded number of referents exist.
- Note: Quantifications other than universal quantification and existential quantification involve cardinalities in a way that requires distinguishability of the things a variable refers to - a means to determine when one thing is not the same thing as another thing. For example, the quantification meant by “at least 2” in “EU-Rent owns at least 2 cars” means that there exists a first car and a second car and the first car is not the second car - the two cars are distinct. Physical things tend to be distinguished intuitively by having different physical locations at any point in time, but abstract things are indistinguishable without distinguishing properties. Reference schemes provide distinguishability and are often particularly important for abstract things.
- Necessity: Each quantification *introduces exactly one* variable.
- Necessity: Each variable *is introduced by at most one* quantification.
- Necessity: Each quantification *scopes over at most one* logical formulation.
- Necessity: A variable that is free within a logical formulation that is scoped over by a quantification *is free within the quantification if and only if the quantification does not introduce the variable*.
- Necessity: A variable that is free within a logical formulation that restricts a variable that is introduced by a quantification *is free within the quantification if and only if the quantification does not introduce the variable*.
- Example: “Each car model is supplied by a car manufacturer”.
The proposition is meant by a universal quantification.
. The universal quantification introduces a first variable.
. . The first variable ranges over the concept ‘car model’.
. The universal quantification scopes over an existential quantification.
. . The existential quantification introduces a second variable.
. . . The second variable ranges over the concept ‘car manufacturer’.
. . The existential quantification scopes over an atomic formulation.
. . . The atomic formulation is based on the verb concept
 ‘car manufacturer supplies car model’.
. . . . The ‘car manufacturer’ role is bound to the second variable.
. . . . The ‘car model’ role is bound to the first variable.

quantification introduces variable

FL

- Definition: the quantification binds the variable such that it is not free within the quantification
- Note: For each referent of the variable the scope formulation, if there is one, is considered with every occurrence of the variable interpreted as referring to the referent.

quantification scopes over logical formulation

FL

- Definition: each referent of the variable introduced by [the quantification](#) satisfies [the logical formulation](#) if the meaning formulated by the scope formulation is true with every occurrence of the variable interpreted as referring to the referent
- Synonymous Form: [quantification has scope formulation](#)
- Note: A [quantification](#) other than a [universal quantification](#) does not necessarily scope over a logical formulation (e.g., formulation of “some customer exists” can simply be an existential quantification introducing a variable that ranges over the concept ‘customer’).
- Note: If a quantification scopes over a logical formulation, the variable introduced by the quantification is a free variable of that logical formulation, except in the rare case of a vacuous quantification.

scope formulation

FL

- Definition: [logical formulation that a given quantification scopes over](#)
- Concept Type: [role](#)

universal quantification

FL

- Definition: [quantification that](#) scopes over a [logical formulation and that](#) has the meaning: for each referent of the [variable](#) introduced by the [quantification](#) the meaning formulated by the [logical formulation](#) for the referent is true
- Concept Type: [logical formulation kind](#)
- Necessity: [Each universal quantification scopes over a logical formulation.](#)
- Reference Scheme: [the logical formulation that is scoped over by the universal quantification and the variable that is introduced by the universal quantification](#)

existential quantification

FL

- Definition: [at-least-n quantification that has the minimum cardinality 1](#)
- Note: An existential quantification, unlike other at-least-n quantifications, does not require distinguishability of referents.
- Reference Scheme: [the set of logical formulations that are scoped over by the existential quantification and the variable that is introduced by the existential quantification](#)

maximum cardinality

FL

- Definition: [nonnegative integer that](#) is an upper bound in a [quantification](#) (such as an [at-most-n quantification](#))
- Concept Type: [role](#)

minimum cardinality

FL

- Definition: [nonnegative integer that](#) is a lower bound in a [quantification](#) (such as an [at-least-n quantification](#))
- Concept Type: [role](#)

at-least-n quantification

FL

- Definition: [quantification that](#) has a [minimum cardinality and that](#) has the meaning: the number of referents of the [variable](#) introduced by the [quantification](#) that exist and that satisfy a [scope formulation](#), if there is one, is not less than the [minimum cardinality](#), and if the [minimum cardinality](#) is greater than one, the referents are distinct

Concept Type: [logical formulation kind](#)

Note: For a minimum cardinality of 1, distinctness of referents is irrelevant.

Necessity: Each [at-least-n quantification](#) *has exactly one* [minimum cardinality](#).

Necessity: The [minimum cardinality of each at-least-n quantification](#) *is a* [positive integer](#).

Reference Scheme: [the minimum cardinality of the at-least-n quantification and the set of logical formulations that are scoped over by the at-least-n quantification and the variable that is introduced by the at-least-n quantification](#)

at-least-n quantification *has* minimum cardinality

FL

Definition: [the at-least-n quantification](#) is satisfied by [the minimum cardinality](#) or greater

at-most-n quantification

FL

Definition: [quantification that](#) has a [maximum cardinality](#) and [that](#) has the meaning: the number of distinct referents of the [variable](#) introduced by the [quantification](#) that exist and that satisfy a [scope formulation](#), if there is one, is not greater than the [maximum cardinality](#)

Concept Type: [logical formulation kind](#)

Necessity: Each [at-most-n quantification](#) *has exactly one* [maximum cardinality](#).

Necessity: The [maximum cardinality of each at-most-n quantification](#) *is a* [positive integer](#).

Reference Scheme: [the maximum cardinality of the at-most-n quantification and the set of logical formulations that are scoped over by the at-most-n quantification and the variable that is introduced by the at-most-n quantification](#)

Example: “Each rental must have at most three additional drivers.” See the introduction to Clause 21 for a semantic formulation of this rule.

at-most-n quantification *has* maximum cardinality

FL

Definition: [the at-most-n quantification](#) is satisfied by [the maximum cardinality](#) or less

at-most-one quantification

FL

Definition: [at-most-n quantification that](#) *has the* [maximum cardinality](#) 1

Note: A number of referents is at most one if and only if every referent is the same referent.

Reference Scheme: [the set of logical formulations that are scoped over by the at-most-one quantification and the variable that is introduced by the at-most-one quantification](#)

exactly-n quantification

FL

Definition: [quantification that](#) has a [cardinality](#) and [that](#) has the meaning: the number of referents of the [variable](#) introduced by the [quantification](#) that exist and that satisfy a [scope formulation](#), if there is one, equals the [cardinality](#)

Necessity: Each [exactly-n quantification](#) *has exactly one* [cardinality](#).

Necessity: The [cardinality of each exactly-n quantification](#) *is a* [positive integer](#).

Reference Scheme: [the cardinality of the exactly-n quantification and the set of logical formulations that are scoped over by the exactly-n quantification and the variable that is introduced by the exactly-n quantification](#)

Note: An [exactly-n quantification](#) is logically equivalent to a [conjunction](#) of an [at-least-n quantification](#) and an [at-most-n quantification](#) using the [cardinality](#) as [minimum cardinality](#) and [maximum cardinality](#) respectively.

exactly-n quantification has cardinality

FL

Definition: the exactly-n quantification is satisfied only by the cardinality

exactly-one quantification

FL

Definition: exactly-n quantification that has the cardinality 1

Note: A number of referents is exactly one if and only if there is a referent and every referent is that same referent.

Concept Type: logical formulation kind

Reference Scheme: the set of logical formulations that are *scoped over by the exactly-one quantification and the variable that is introduced by the exactly-one quantification*

numeric range quantification

FL

Definition: quantification that has a minimum cardinality and a maximum cardinality greater than the minimum cardinality and that has the meaning: the number of referents of the variable introduced by the quantification that exist and that satisfy a scope formulation, if there is one, is not less than the minimum cardinality and is not greater than the maximum cardinality

Concept Type: logical formulation kind

Necessity: Each numeric range quantification has exactly one maximum cardinality.

Necessity: Each numeric range quantification has exactly one minimum cardinality.

Necessity: The minimum cardinality of each numeric range quantification is less than the maximum cardinality of the numeric range quantification.

Reference Scheme: the minimum cardinality of the numeric range quantification and the maximum cardinality of the numeric range quantification and the set of logical formulations that are *scoped over by the numeric range quantification and the variable that is introduced by the numeric range quantification*

Note: A numeric range quantification is logically equivalent to a conjunction of an at-least-n quantification and an at-most-n quantification using the minimum cardinality and maximum cardinality respectively.

numeric range quantification has maximum cardinality

FL

Definition: the numeric range quantification cannot be satisfied by a number greater than the maximum cardinality

numeric range quantification has minimum cardinality

FL

Definition: the numeric range quantification cannot be satisfied by a number less than the minimum cardinality

21.3.7 Objectifications

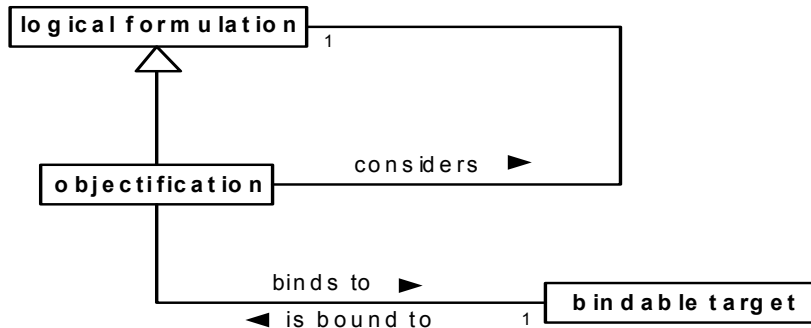

Figure 21.9

This diagram shows the SBVR terminological entries of this sub clause as explained in Annex C.

objectification

FL

Definition:	<u>logical formulation</u> that involves a <u>bindable target</u> and a considered <u>logical formulation</u> and that formulates the meaning: the thing to which the <u>bindable target</u> refers is a <u>state of affairs</u> to which the meaning of the considered <u>logical formulation</u> corresponds
Concept Type:	<u>logical formulation kind</u>
Note:	An objectification is similar to an instantiation formulation in that it is satisfied by a correspondence of a referent thing to a meaning. For an instantiation formulation the meaning is a concept. For an objectification the meaning is a proposition.
Necessity:	Each <u>objectification</u> <i>considers</i> exactly one <u>logical formulation</u> .
Necessity:	Each <u>objectification</u> <i>considers</i> exactly one <u>logical formulation</u> .
Necessity:	Each <u>objectification</u> <i>binds to</i> exactly one <u>bindable target</u> .
Necessity:	Each <u>variable</u> that <i>is bound to</i> an <u>objectification</u> <i>is free within</i> the <u>objectification</u> .
Necessity:	Each <u>variable</u> that <i>is free within</i> the <u>logical formulation</u> that <i>is considered by</i> an <u>objectification</u> <i>is free within</i> the <u>objectification</u> .
Reference Scheme:	the <u>bindable target</u> that <i>is bound to</i> the <u>objectification</u> and the <u>logical formulation</u> that <i>is considered by</i> the <u>objectification</u>
Example:	<p>‘late return’ defined as “actuality that a given rental is returned late”.</p> <p>The concept ‘late return’ is defined by a closed projection.</p> <ul style="list-style-type: none"> . The projection is on a first variable. .. The first variable ranges over the concept ‘actuality’. . The projection has an auxiliary variable. .. The auxiliary variable ranges over the concept ‘rental’. . The projection is constrained by an objectification. .. The objectification binds to the first variable. .. The objectification considers an atomic formulation. ... The atomic formulation is based on the characteristic ‘rental is returned late’. The ‘rental’ role is bound to the auxiliary variable.
Example:	<p>“EU-Rent reviews each corporate account at EU-Rent Headquarters”.</p> <p>The statement above could be formulated using a ternary verb concept ‘company reviews</p>

account at place', but such a verb concept is not likely represented in a business vocabulary because it mixes two orthogonal binary verb concepts: 'company reviews account' and 'state of affairs occurs at place'. The formulation below uses the two binary verb concepts and employs an objectification to tie them together.

The statement is formulated by a universal quantification.

. The quantification introduces a first variable.

.. The first variable ranges over the concept 'corporate account'.

. The quantification scopes over an existential quantification.

... The existential quantification introduces a second variable.

... The second variable ranges over the concept 'state of affairs'.

... The second variable is restricted by an objectification.

... The objectification binds to the second variable.

... The objectification considers an atomic formulation.

... The atomic formulation is based on the verb concept 'company reviews account'.

... The 'company' role is bound to the individual noun concept 'EU-Rent'.

... The 'account' role is bound to the first variable.

... The existential quantification scopes over an atomic formulation.

... The atomic formulation is based on the verb concept 'state of affairs occurs at place'.

... The 'state of affairs' role is bound to the second variable.

... The 'place' role is bound to the individual noun concept 'EU-Rent Headquarters'.

Example: "EU-Rent has reviewed each corporate account".

The verb concept 'company reviews account' can be used to formulate the meaning of 'company has reviewed account' (the present perfect tense) by using an objectification along with a generic verb concept for the present perfect tense, 'state of affairs has occurred'. A formulation of the example statement is similar to that of the previous example but uses the verb concept 'state of affairs has occurred' rather than 'state of affairs occurs at place'.

Example: "EU-Rent privately reviews each corporate account".

A formulation of the example statement is similar to that of the previous two examples, but uses the verb concept 'state of affairs occurs privately'.

Example: "If a rental car is returned late because the car has a mechanical breakdown ...". In a possible formulation of this example, objectifications of "the car has a mechanical breakdown" and "the rental car is returned late" respectively formulate something for each role of the verb concept 'actuality causes actuality'.

objectification considers logical formulation

FL

Definition: the objectification is of the state or event that corresponds to the meaning of the logical formulation

objectification binds to bindable target

FL

Definition: the bindable target indicates the referent state or event identified by the objectification

Synonymous Form: bindable target is bound to objectification

21.3.8 Projecting Formulations

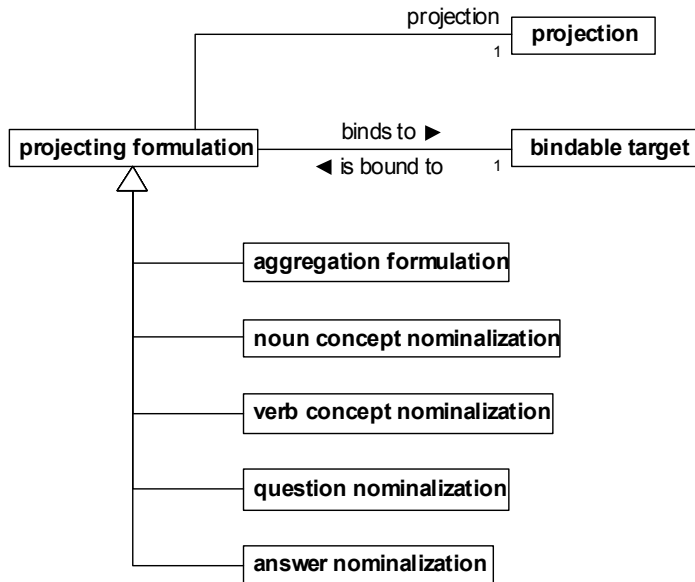

Figure 21.10

This diagram shows the SBVR terminological entries of this sub clause as explained in Annex C.

projecting formulation

FL

- Definition: [logical formulation](#) of a referent [thing](#) considered with respect to a particular [projection](#)
- Necessity: Each [projecting formulation](#) *has exactly one* [projection](#).
- Necessity: Each [projecting formulation](#) *binds to exactly one* [bindable target](#).
- Necessity: Each [variable](#) that *is bound to a projecting formulation is free within the projecting formulation*.
- Necessity: Each [variable](#) that *is free within the projection of a projecting formulation is free within the projecting formulation*.
- Note: The concept ‘projecting formulation’ is abstract. See its specializations for semantics.
- Example: See ‘[aggregation formulation](#)’, ‘[question nominalization](#)’, and ‘[answer nominalization](#)’.

projecting formulation *has* projection

FL

- Definition: *the* [projecting formulation](#) is based on the [projection](#)

projecting formulation *binds to* bindable target

FL

- Definition: *the* [bindable target](#) indicates the referent [thing](#) considered by *the* [projecting formulation](#)
- Synonymous Form: [bindable target](#) *is bound to* [projecting formulation](#)

aggregation formulation

FL

- Definition: [projecting formulation](#) that formulates the meaning: the thing to which the [bindable target](#) bound to the [projecting formulation](#) refers is the result of the [projection](#) of the [projecting formulation](#)
- Note: The aggregation formulation is used primarily to associate a variable with a set of things, involvements, or actualities that satisfy some condition. That is, it formulates natural language expressions of the form: “let *<variable>* be the set of all things *t* such that *<some condition involving t>*,” so that *<variable>* can then be used in other formulations regarding the set. The *<condition involving t>* often includes some free variable introduced in the context in which the formulation is used.
- Concept Type: [logical formulation kind](#)
- Necessity: The [projection of each aggregation formulation is on exactly one variable](#).
- Reference Scheme: the [bindable target that is bound to the aggregation formulation and the projection of the aggregation formulation](#)
- Example: “The number of rental cars stored at a given branch must not exceed the car storage capacity of the branch.” This example considers the number of elements in a set (the set of rental cars stored at a branch). The projection of an aggregation formulation is used to define that set, and the aggregation formulation restricts the third variable below so that its referent is that set. The statement is formulated by an obligation formulation.
- . The obligation formulation embeds a first universal quantification.
 - . . The first universal quantification introduces a first variable.
 - . . . The first variable ranges over the concept ‘branch’.
 - . . The first universal quantification scopes over a second universal quantification.
 - . . . The second universal quantification introduces a second variable.
 - The second variable ranges over the concept ‘number’.
 - The second variable is unitary.
 - The second variable is restricted by a third universal quantification.
 - The third universal quantification introduces a third variable.
 - The third variable ranges over the concept ‘set’.
 - The third variable is unitary.
 - The third variable is restricted by an aggregation formulation.
 - The aggregation formulation binds to the third variable.
 - The aggregation formulation considers a projection.
 - The projection is on a fourth variable.
 - The fourth variable ranges over the concept ‘rental car’.
 - The projection is constrained by an atomic formulation.
 - The atomic formulation is based on the verb concept ‘[rental car](#) is stored at [branch](#)’.
 - The ‘[rental car](#)’ role is bound to the fourth variable.
 - The ‘[branch](#)’ role is bound to the first variable.
 - The third universal quantification scopes over an atomic formulation.
 - The atomic formulation is based on the verb concept ‘[set](#) has [number](#)’.
 - The ‘[set](#)’ role is bound to the third variable.
 - The ‘[number](#)’ role is bound to the second variable.
 - The second universal quantification scopes a fourth universal quantification.
 - The fourth universal quantification introduces a fifth variable.
 - The fifth variable ranges over the concept ‘car storage capacity’.

- The fifth variable is unitary.
- The fifth variable is restricted by an atomic formulation.
- The atomic formulation is based on the verb concept
 - ‘branch has car storage capacity’.
- The ‘branch’ role is bound to the first variable.
- The ‘car storage capacity’ role is bound to the fifth variable.
- The fourth universal quantification scopes over a logical negation.
- The logical operand of the logical negation is an atomic formulation.
- The atomic formulation is based on the verb concept ‘number₁ exceeds number₂’.
- The ‘number₁’ role is bound to the second variable.
- The ‘number₂’ role is bound to the fifth variable.

noun concept nominalization

FL

- Definition: [projecting formulation](#) that formulates the meaning: the thing to which the [bindable target](#) bound to the [projecting formulation](#) refers is a [noun concept](#) that is defined by the [projection](#) of the [projecting formulation](#)
- Concept Type: [logical formulation kind](#)
- Necessity: [The projection of each noun concept nominalization is on exactly one variable.](#)
- Note: In the case of variables being free within a projection of a noun concept nominalization, the projection is considered to define a noun concept only in the context of there being a referent thing given for each free variable.
- Note: Nouns are generally used to refer to things in the extension of the noun concept meant by the noun. Less commonly, a noun is used to mention a noun concept itself. This is referred to as a “mention” of the concept as opposed to a “use.”
- Reference Scheme: [the bindable target that is bound to the noun concept nominalization and the projection of the noun concept nominalization](#)
- Example: “‘SUV’ is a vehicle type”. In this example, the noun concept ‘SUV’ is mentioned as a concept rather than used to refer to SUVs.
 The statement is formulated by an existential quantification.
 . The existential quantification introduces a unitary variable.
 . . The unitary variable ranges over the concept ‘noun concept’.
 . . The unitary variable is restricted by a noun concept nominalization.
 . . . The noun concept nominalization binds to the unitary variable.
 . . . The noun concept nominalization considers a projection.
 The projection is on one projection variable.
 The projection variable ranges over the noun concept ‘SUV’.
 . The existential quantification scopes over an instantiation formulation.
 . . The instantiation formulation considers the concept ‘vehicle type’.
 . . The instantiation formulation binds to the unitary variable.
- Example: “No rental’s pick-up branch changes”.
 The statement is formulated by a logical negation.
 . The logical operand of the logical negation is an existential quantification.
 . . The quantification introduces a first variable.
 . . . The first variable ranges over the concept ‘rental’.
 . . The quantification scopes over a second existential quantification.
 . . . The quantification ranges over a second variable, which is unitary.
 The second variable ranges over the concept ‘unitary noun concept’.
 The second variable is restricted by a noun concept nominalization.

. The noun concept nominalization binds to the second variable.
 The noun concept nominalization considers a projection.
 The projection is on a third variable, which is unitary.
 The third variable ranges over the concept ‘pick-up branch’.
 The projection is constrained by an atomic formulation.
 The atomic formulation is based on the verb concept ‘rental has pick-up branch’.
 The ‘rental’ role binds to the first variable.
 The ‘pick-up branch’ role binds to the third variable.
 . . . The second quantification scopes over an atomic formulation.
 . . . The atomic formulation is based on the verb concept ‘unitary noun concept* changes’.
 . . . The ‘unitary noun concept*’ role binds to the second variable.
 (See C.1.6, Intensional Roles, about the verb concept ‘unitary noun concept* changes.’)

verb concept nominalization

FL

Definition:	<u>projecting formulation</u> that formulates the meaning: the thing to which the <u>bindable target</u> bound to the <u>projecting formulation</u> refers is a <u>verb concept</u> that is defined by the <u>projection</u> of the <u>projecting formulation</u>
Concept Type:	<u>logical formulation kind</u>
Reference Scheme:	the <u>bindable target</u> that <i>is bound to</i> the <u>verb concept nominalization</u> and the <u>projection of the verb concept nominalization</u>
Note:	A verb concept nominalization formulates the (anonymous) verb concept defined by a projection. In most uses of verb concept nominalizations, the bindable target is a unitary variable, and the effect is to define the variable to refer to the anonymous verb concept defined by the projection. It is the only referent for which the verb concept nominalization will hold.
Note:	In the case of variables being free within a projection of a verb concept nominalization, the projection is considered to define a verb concept only in the context of there being a referent thing substituted for each free variable.
Note:	More information about how a projection defines a verb concept is in the entry for ‘ <u>closed projection defines verb concept</u> ’. A verb concept nominalization nominalizes only a verb concept, not its roles.
Example:	<p>“Being established by a rental booking is a characteristic attributed to each advance rental”. The characteristic expressed as “being established by a rental booking” is nominalized within the statement.</p> <p>The statement is formulated by a universal quantification.</p> <p>. The universal quantification introduces a first variable.</p> <p>. . The first variable ranges over the concept ‘advance rental’.</p> <p>. . The universal quantification scopes over a first existential quantification.</p> <p>. . The first existential quantification introduces a second variable.</p> <p>. . . The second variable ranges over the concept ‘characteristic’.</p> <p>. . . The second variable is restricted by an atomic formulation.</p> <p>. . . . The atomic formulation is based on the verb concept ‘<u>characteristic</u> is attributed to <u>thing</u>’.</p> <p>. The ‘<u>characteristic</u>’ role is bound to the second variable.</p> <p>. The ‘<u>thing</u>’ role is bound to the first variable.</p> <p>. . The first existential quantification scopes over a verb concept nominalization.</p> <p>. . . The verb concept nominalization binds to the second variable.</p> <p>. . . The verb concept nominalization considers a projection.</p> <p>. . . . The projection is on a third variable.</p> <p>. . . . The projection is constrained by a second existential quantification.</p> <p>. The second existential quantification introduces a fourth variable.</p>

- The fourth variable ranges over the concept ‘rental booking’.
- The second existential quantification scopes over an atomic formulation.
- The atomic formulation is based on the verb concept
‘rental booking establishes advanced rental’.
- The ‘rental booking’ role is bound to the fourth variable.
- The ‘advanced rental’ role is bound to the third variable.

21.3.9 Nominalizations of Propositions and Questions

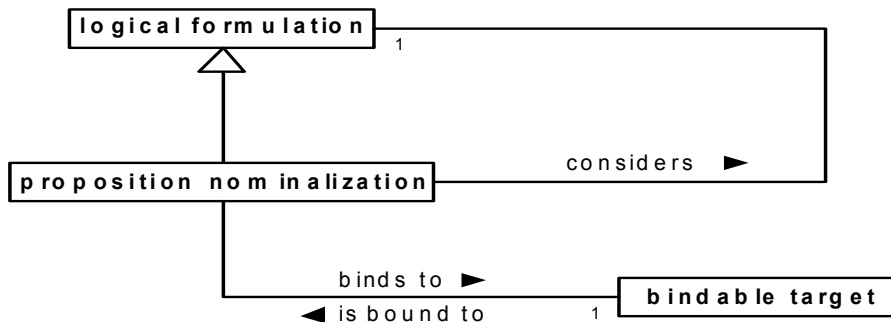

Figure 21.11

This diagram shows the SBVR terminological entries of this sub clause as explained in Annex C.

proposition nominalization

FL

- Definition: [logical formulation](#) that involves a [bindable target](#) and a considered [logical formulation](#) and that formulates the meaning: the thing to which the [bindable target](#) refers is the [proposition](#) that is formulated by the considered [logical formulation](#)
- Concept Type: [logical formulation kind](#)
- Necessity: Each [proposition nominalization](#) *considers* exactly one [logical formulation](#).
- Necessity: Each [proposition nominalization](#) *binds to* exactly one [bindable target](#).
- Necessity: Each [variable](#) that *is bound to* a [proposition nominalization](#) *is free within the proposition nominalization*.
- Necessity: Each [variable](#) that *is free within the logical formulation* that *is considered by a proposition nominalization* *is free within the proposition nominalization*.
- Note: A closed logical formulation means exactly one proposition. An open logical formulation does not mean any proposition. In the case of variables being free within a considered logical formulation, the formulation is considered to mean a proposition only in the context of there being a referent thing given for each free variable.
- Note: The truth of a nominalized proposition is not relevant to the satisfaction of the [proposition nominalization](#).
- Reference Scheme: [the bindable target](#) that *is bound to* the [proposition nominalization](#) and the [logical formulation](#) that *is considered by* the [proposition nominalization](#)
- Example: “Each EU-Rent branch posts a sign stating that no personal checks are accepted by the branch”.
The statement is formalized by a universal quantification.

- . The universal quantification is on a first variable.
- .. The variable ranges over the concept 'EU-Rent branch'.
- . The universal quantification scopes over an existential quantification.
- .. The existential quantification introduces a second variable.
- ... The second variable ranges over the concept 'sign'.
- ... The second variable is restricted by a second existential quantification.
- The second existential quantification introduces a third variable.
- The third variable ranges over the concept 'proposition'.
- The third variable is restricted by a proposition nominalization.
- The proposition nominalization binds to the third variable
- The proposition nominalization considers a logical negation.
- The logical operand of the negation is a third existential quantification.
- The quantification introduces a fourth variable.
- The variable ranges over the concept 'personal check'.
- The quantification scopes over an atomic formulation.
- The atomic formulation is based on the verb concept
'branch accepts monetary instrument'.
- The 'branch' role is bound to the first variable.
- The 'monetary instrument' role is bound to the fourth variable.
- The second existential quantification scopes over an atomic formulation.
- The atomic formulation is based on the verb concept 'sign states proposition'.
- The 'sign' role is bound to the second variable.
- The 'proposition' role is bound to the third variable.
- .. The first existential quantification scopes over an atomic formulation.
- .. The atomic formulation is based on the verb concept 'branch posts sign'.
- ... The 'branch' role is bound to the first variable.
- ... The 'sign' role is bound to the second variable.

proposition nominalization *considers* logical formulation

FL

Definition: the proposition nominalization nominalizes the proposition whose meaning is formulated by the logical formulation

proposition nominalization *binds to* bindable target

FL

Definition: the bindable target indicates the referent proposition identified by the proposition nominalization

Synonymous Form: bindable target is bound to proposition nominalization

question nominalization

Definition: projecting formulation *that* formulates the meaning: the thing to which the bindable target bound to the projecting formulation refers is the question that is meant by the projection of the projecting formulation

Concept Type: logical formulation kind

Note: See 'closed projection means question' for an explanation and examples of how questions are formulated.

Note: A closed projection means at most one question. In the case of variables being free within a projection, the projection is considered to mean a question only in the context of there being a referent thing given for each free variable.

Reference Scheme: the bindable target that is bound to the question nominalization and the projection of the question nominalization

Example: “An agent asks each customer what car model the customer prefers”.

The statement is formulated by a universal quantification.

- . The quantification introduces a first variable.
- .. The first variable ranges over the concept ‘customer’.
- . The quantification scopes over an existential quantification.
- .. The existential quantification introduces a second variable.
- ... The second variable ranges over the concept ‘agent’.
- .. The existential quantification scopes over a second existential quantification.
- ... The second existential quantification introduces a third variable.
- The third variable ranges over the concept ‘question’.
- The third variable is restricted by a question nominalization.
- The question nominalization binds to the third variable.
- The question nominalization considers a projection.
- The projection is on a fourth variable.
- The variable ranges over the concept ‘car model’.
- The projection is constrained by an atomic formulation.
- The atomic formulation is based on the verb concept ‘person prefers car model’.
- The ‘person’ role is bound to the first variable.
- The ‘car model’ role is bound to the fourth variable.
- ... The second existential quantification scopes over an atomic formulation.
- The atomic formulation is based on the verb concept ‘person₁ asks person₂ question’.
- The ‘person₁’ role is bound to the second variable.
- The ‘person₂’ role is bound to the first variable.
- The ‘question’ role is bound to the third variable.

answer nominalization

Definition: [projecting formulation](#) that formulates the meaning: the thing to which the [bindable target](#) bound to the [projecting formulation](#) refers is a [proposition](#) that is true and that completely and correctly answers the question meant by the [projection](#) of the [projecting formulation](#)

Concept Type: [logical formulation kind](#)

Note: See ‘[closed projection means question](#)’ for an explanation and examples of how questions are formulated.

Note: In the case of variables being free within a projection, the projection is considered to mean a question only in the context of there being a referent thing given for each free variable.

Note: A thing referred to by a bindable target bound to an answer nominalization is a satisfactory proposition if it correctly and completely holds the result of the answer nominalization’s projection. A satisfying proposition incorporates the meaning formulated by the projection in the context of there being a referent thing given for each free variable of the projection. Further, the satisfying proposition refers to each referent of each variable in the projection. If the projection result has multiple elements, a satisfying proposition holds them all, conjunctively. If the projection result is empty, a satisfying projection indicates that it is empty.

Note: Each reference in a satisfying answer should use a defined reference scheme.

Reference Scheme: [the bindable target that is bound to the answer nominalization and the projection of the answer nominalization](#)

Example: “An agent tells each customer what special offer is available to the customer”.

The statement is formulated by a universal quantification.

- . The quantification introduces a first variable.

- .. The first variable ranges over the concept ‘customer’.
- . The quantification scopes over an existential quantification.
- .. The existential quantification introduces a second variable.
- ... The second variable ranges over the concept ‘agent’.
- .. The existential quantification scopes over a second existential quantification.
- ... The second existential quantification introduces a third variable.
- The third variable ranges over the concept ‘proposition’.
- The third variable is restricted by an answer nominalization.
- The answer nominalization binds to the third variable.
- The answer nominalization considers a projection.
- The projection is on a fourth variable.
- The variable ranges over the concept ‘special offer’.
- The projection is constrained by an atomic formulation.
- The atomic formulation is based on the verb concept ‘special offer is available to customer’.
- The ‘special offer’ role is bound to the fourth variable.
- The ‘customer’ role is bound to the first variable.
- .. The second existential quantification scopes over an atomic formulation.
- ... The atomic formulation is based on the verb concept ‘person₁ tells person₂ proposition’.
- The ‘person₁’ role is bound to the second variable.
- The ‘person₂’ role is bound to the first variable.
- The ‘proposition’ role is bound to the third variable.

If exactly two special offers (Gold Customer Discount and Free One-level Upgrade) are available to a customer having customer id ‘9876’, a satisfying answer for that customer would be the proposition meant by the statement: “The special offers available to the customer having the customer id ‘9876’ are the Gold Customer Discount and the Free One-level Upgrade.”

21.4 Projections

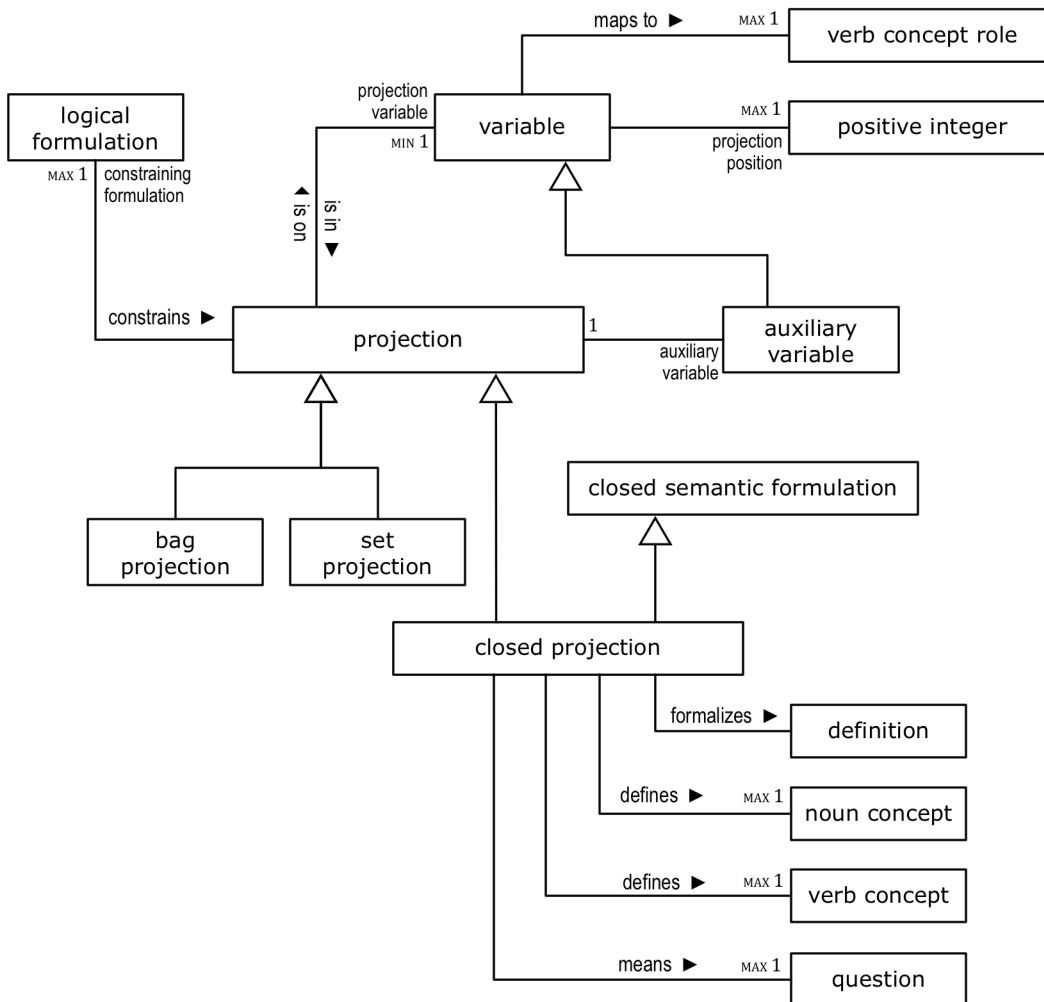

Figure 21.12

This diagram shows the SBVR terminological entries of this sub clause as explained in Annex C.

projection

FL

Definition: **semantic formulation** *that* introduces one or more variables corresponding to involvements in actualities *and that* is possibly constrained by a logical formulation *and that* projects one or more of those variables

Necessity: Each **projection** *is on at least one* **variable**.

Necessity: Each **projection** *is constrained by at most one* **logical formulation**.

Necessity: A variable that is free within a logical formulation that constrains a projection is free within the projection if and only if the projection is not on the variable and the variable is not an auxiliary variable of the projection.

Necessity: No projection is a logical formulation.

Necessity: A variable that is in a projection is not free within the projection.

Necessity: A variable that is free within a logical formulation that restricts another variable that is in a projection is free within the projection.

Necessity: A variable that is free within a logical formulation that restricts an auxiliary variable of a projection is free within the projection if and only if the variable is not the auxiliary variable.

Note: A restriction on a variable introduced by a projection cannot involve any other variable introduced by the projection.

Reference Scheme: the set of variables that are in the projection and the set of auxiliary variables of the projection and the set of logical formulations that constrain the projection

Note: A projection is a structure of meaning used in formulating different kinds of meanings. Each is explained separately. See the following entries: ‘closed projection defines noun concept’, ‘closed projection defines verb concept’, and ‘closed projection means question’. Also, projections are incorporated into projecting formulations, which include ‘aggregation formulation’, ‘noun concept nominalization’, ‘verb concept nominalization’, ‘question nominalization’, and ‘answer nominalization’ each of which is explained separately with examples in previous sub clauses.

Note: A projection introduces one or more variables corresponding to involvements in actualities. If the projection is constrained by a logical formulation, then for each combination of variables, one referent for each variable, the actuality is that the meaning of the constraining formulation is true. If the projection has no constraining formulation, then for each combination of variables, one referent for each variable, the actuality is that the referents exist.

That is, the basic meaning of a projection is a verb concept in which all of the variables introduced by the projection correspond to roles. The basic meaning corresponds to actualities for which the following proposition holds:

t_1 is a valid referent of v_1
[AND t_2 is a valid referent of v_2
...
AND t_n is a valid referent of v_n]
[AND $S(t_1, \dots, t_n)$]

where v_1, \dots, v_n are the variables introduced by the projection, t_1, \dots, t_n are things, and $S(t_1, \dots, t_n)$ is the proposition formulated by the logical formulation that constrains the projection, if any, with those things substituted for the occurrences of the corresponding variables.

The meaning of a projection in some uses, however, can be restricted to refer to the involvements of the things in the roles (denoted by the projection variables) in those actualities, or to the things that have those involvements.

Note: Projections introduce variables in two ways: projection variables (variables that the projection ‘is on’) and auxiliary variables. Both correspond to involvements in the actualities that correspond to the basic meaning, but the result of a projection includes only the involvements that correspond to the projection variables. Auxiliary variables are used in selecting the

actualities that correspond to the projection, but are not part of the intent of the projection itself.

projection is on variable

FL

- Definition: **the projection** introduces **the variable** such that satisfying referents of **the variable** are in the result of **the projection**
- Synonymous Form: **variable is in projection**
- Synonymous Form: **projection has projection variable**
- Necessity: **No variable that is in a projection is introduced by a quantification.**

projection has auxiliary variable

FL

- Definition: **the auxiliary variable** is introduced by **the projection**, but is left out of the result of **the projection** thereby giving the possibility of duplicates in a result
- Necessity: **No auxiliary variable is introduced by a quantification.**
- Necessity: **No projection is on an auxiliary variable.**
- Necessity: **Each projection that has an auxiliary variable is constrained by a logical formulation.**

logical formulation constrains projection

FL

- Definition: **the logical formulation** determines which referents of the variables introduced by **the projection** are in the result of **the projection**
- Synonymous Form: **projection has constraining formulation**
- Note: A logical formulation that constrains a projection restricts the results of the projection. If there is no constraining logical formulation, then there is no restriction other than what is on variables in the projection.

auxiliary variable

FL

- Definition: **variable that** is introduced by a **projection**, but which is left out of the result of the **projection** thereby giving the possibility of duplicate results
- Necessity: **Each auxiliary variable is of exactly one projection.**
- Reference Scheme: **a projection that has the auxiliary variable and a projection position of the auxiliary variable and the set of concepts that are ranged over by the auxiliary variable and the set of logical formulations that restrict the auxiliary variable and whether the auxiliary variable is unitary**

projection position

FL

- Definition: **positive integer that** distinguishes a **variable** introduced by a projection from others introduced by the same projection
- Concept Type: **role**

variable has projection position

FL

- Definition: **the variable** is introduced by a **projection** and has the unique **projection position** among the set of variables introduced by that **projection**
- Necessity: **Each variable has at most one projection position.**
- Necessity: **Each variable that is in a projection has exactly one projection position.**
- Necessity: **Each auxiliary variable has exactly one projection position.**

set projection

FL

- Definition: [projection that has no auxiliary variable](#)
- Example: A [projection](#) formalizing the expression, “customers that are preferred,” is on a single [variable](#) (customer). There is no [auxiliary variable](#), so the result is necessarily a set.

bag projection

FL

- Definition: [projection that has an auxiliary variable](#)
- Note: A bag projection treats the resulting set of actualities as a set of the corresponding involvements of referents of the projection variables in roles in those actualities. A thing that participates in those involvements may participate in more than one involvement and therefore have multiple “occurrences” in the projection result. In many cases, the use of the projection reduces the set of involvements to the set of things involved (and ignores the fact of multiple occurrence). But in some cases the distinguished involvements/occurrences are important.
- Example: A [projection](#) formalizing the expression, “account balances of customers that are preferred,” is on a [variable](#) (account balance) and has an [auxiliary variable](#) (customer). Only balances are in the result, but there can be duplicates where multiple customers have the same balance.

closed projection

FL

- Definition: [projection that is a closed semantic formulation](#)
- Example: A [projection](#) formalizing the expression, “customers that are preferred,” is closed – there is no variable that is not introduced. But within a formulation of the expression, “Each branch must report the number of car models offered by the branch,” the [projection](#) of “car models offered by the branch” is open because it binds to a [variable](#) (branch) that is introduced outside of the [projection](#).

closed projection formalizes definition

- Definition: [the definition](#) conveys the meaning formulated by [the closed projection and the closed projection](#) refers to the concepts represented in [the definition](#)
- Example: The one concept ‘local car movement’ can be defined as “one-way car movement that is in-area” or as “car movement that is in-area and that is not round-trip.” Both definitions have the same meaning, but one is formalized in reference to the noun concept ‘one-way car movement’ (defined as “car movement that is not round-trip”) and the other in reference to the characteristic ‘[car movement](#) is round-trip’. The two formulations are different but mean the same noun concept.
- Necessity: [Each closed projection that formalizes a definition of a noun concept defines the noun concept.](#)
- Necessity: [Each closed projection that formalizes a definition of a verb concept defines the verb concept.](#)

closed projection defines noun concept

FL

- Definition: [the closed projection](#) is on exactly one variable and [the closed projection](#) formulates a set of incorporated characteristics sufficient to determine [the noun concept](#)
- Necessity: [Each closed projection that defines a noun concept is on at most one variable.](#)
- Necessity: [If a closed projection that defines a noun concept is a set projection that is on a variable that is unitary then the noun concept is an individual noun concept.](#)
- Note: A closed projection defines a noun concept by formulating a set of incorporated characteristics that determine the noun concept. These incorporated characteristics include:

1. All characteristics of the ranged-over concept of the projection variable of the projection, if there is one.
2. If a logical formulation restricts the projection variable, the meaning of that formulation with respect to the projection variable.
3. If the projection has a constraining formulation and the projection has no auxiliary variable, the meaning of the constraining formulation with respect to the projection variable.
4. If the projection has a constraining formulation and the projection has an auxiliary variable, the characteristic of being involved in an actuality that corresponds to the “basic meaning” of the projection.

Note: When a projection defines a noun concept, it restricts the basic meaning (the set of corresponding actualities) to the involvements in those actualities that are denoted by the projection variable, and further to the things participating in those involvements – the things that play the corresponding role. If there are auxiliary variables, a given thing may participate in more than one such involvement. In many cases, however, the projection introduces only one variable and the actualities are of things having a particular property. If a projection that defines a general concept has an auxiliary variable, the general concept incorporates the characteristic of being involved in an actuality that also involves a referent of the auxiliary variable, as if the auxiliary variable is existentially quantified. The characterization is from the perspective of a referent of the auxiliary variable.

Example: The general concept ‘wrecked car’ defined as “car that is disabled by an accident”
 A closed projection defines the general concept.
 . The projection is on a first variable.
 . . The first variable ranges over the concept ‘car’.
 . The projection is constrained by an existential quantification.
 . . The quantification is on a second variable.
 . . . The second variable ranges over the concept ‘accident’.
 . . The quantification scopes over an atomic formulation.
 . . . The atomic formulation is based on the verb concept ‘accident disables vehicle’.
 The ‘accident’ role is bound to the second variable.
 The ‘vehicle’ role is bound to the first variable.

closed projection defines verb concept

Definition: the closed projection is on one variable for each role of the verb concept and the closed projection identifies enough characteristics incorporated by the verb concept that all of its incorporated characteristics can be determined

Necessity: If a closed projection defines a verb concept and the closed projection defines a noun concept then the verb concept is a characteristic and the role of the characteristic is coextensive with the noun concept.

Note: If a closed projection defines a verb concept, each variable introduced by the projection, including auxiliary variables, is understood as a point of involvement in actualities that are instances of the verb concept. If the projection has a constraining formulation, the meaning of the verb concept for each combination of referents, one for each variable, is the proposition meant by the logical formulation. If no logical formulation constrains the projection, then the meaning of the verb concept for each combination of referents is that the referents all exist.

Note: A verb concept defined by a closed projection incorporates the following characteristics:

1. All characteristics of the concept ‘actuality’.
2. Each instance of the verb concept involves exactly one thing in each role of the verb concept – see ‘variable maps to verb concept role’ below.

3. If the projection has a constraining formulation and the projection has no auxiliary variable, the meaning of the constraining formulation with respect to the projection variables.
4. If the projection has a constraining formulation and the projection has an auxiliary variable, the meaning of the constraining formulation with respect to the projection variables and of involving a given referent of each auxiliary variable of the projection in its corresponding role of the “base meaning.”

Example: The characteristic ‘car is wrecked’ defined as “the car is disabled by an accident.” The closed projection given in the example under ‘[closed projection defines noun concept](#)’ above as defining ‘wrecked car’ also defines this characteristic. The difference between the characteristic and the noun concept is that the extension of the noun concept is the set of wrecked cars while the extension of the characteristic is the set of actualities that a given car is wrecked. Elements of the two extensions are related one-to-one.

Example: The binary verb concept ‘accident disables vehicle’ defined as “the accident causes the vehicle to be nonoperational”.

The binary verb concept is defined by a closed projection.

. The projection is on a first variable.

.. The first variable ranges over the concept ‘vehicle’.

. The projection is on a second variable.

.. The second variable ranges over the concept ‘accident’.

. The projection is constrained by an existential quantification.

.. The existential quantification is on a third variable.

... The third variable is restricted by an objectification.

.... The objectification binds to the third variable.

.... The objectification considers an atomic formulation.

..... The atomic formulation is based on the verb concept ‘vehicle is nonoperational’.

..... The ‘vehicle’ role is bound to the first variable.

.. The existential quantification scopes over an atomic formulation.

... The atomic formulation is based on the verb concept ‘event causes state of affairs’.

.... The ‘event’ role is bound to the second variable.

.... The ‘state of affairs’ role is bound to the third variable.

variable maps to verb concept role

FL

Definition: **the variable** is in a [closed projection](#) that defines the [verb concept](#) that has **the verb concept role** such that for each element in the projection result the referent of the variable is involved in **the verb concept role** in a corresponding [actuality](#) in the [extension](#) of the [verb concept](#)

Synonymous Form: [verb concept role is mapped from variable](#)

Necessity: **If a [closed projection](#) defines a [verb concept](#) then each role of the [verb concept](#) is mapped from exactly one [variable](#) that is in the [closed projection](#) and each [variable](#) that is in the [closed projection](#) maps to exactly one role of the [verb concept](#).**

Necessity: **A [variable](#) maps to a [verb concept role](#) only if a [closed projection](#) that is on the [variable](#) defines a [verb concept](#) that has the [verb concept role](#).**

Necessity: **Each [variable](#) maps to at most one [verb concept role](#).**

Note: A verb concept role that is mapped from a projection variable of a closed projection incorporates the following characteristics (which are the same as if a general concept is defined by the projection with the one modification that all other introduced variables are auxiliary):

1. All characteristics of the ranged-over concept of the variable, if there is one.

2. If a logical formulation restricts the variable, the meaning of that formulation with respect to the variable.
3. If the projection has a constraining formulation, the characteristic of being involved as a referent of the variable in a given actuality denoted by the constraining formulation.

Example: The ‘car’ role of the characteristic ‘car is wrecked’ in the example above under ‘closed projection defines verb concept’ is mapped from the one variable in the closed projection that defines the characteristic. Note that the role incorporates the same characteristics as the noun concept ‘wrecked car’, and is therefore coextensive with it.

Example: In the binary verb concept ‘accident disables vehicle’ in the example above under ‘closed projection defines verb concept’, the ‘accident’ role is mapped from the first variable and the ‘vehicle’ role is mapped from the second variable in the projection that defines the binary verb concept.

closed projection means question

Definition: the closed projection formulates the question such that the result of the projection answers the question

Necessity: Each closed projection means at most one question.

Note: A question using an interrogative operator such as ‘what’, ‘when’, ‘where’, ‘why’, or ‘how’ is generally formulated by a projection on a variable that ranges over a concept that matches the operator. The interrogative ‘what’ is often used with a designation of a noun concept such as in “What car is available?” in which case the variable ranges over the noun concept ‘car’. For each of the other operators the variable ranges over a noun concept fitting to that operator as if ‘what’ had been used with a designation for that concept. Examples of the correspondence of interrogative operators to noun concepts is shown below.

“When is a car available?”	What <u>time</u>
“How is a car driven?”	What <u>method</u>
“Where is a car?”	What <u>location</u>
“Who can drive a car?”	What <u>person</u>
“Why is a car available?”	What <u>cause</u>

Note that definition of these nouns (underlined above) is outside the scope of SBVR. However, the concept ‘cause’ is a role that ranges over the concept ‘actuality’ so an answer to a ‘why’ question is often formulated using an objectification (the last example under ‘objectification’ considers one actuality as a cause of another).

Note: A true/false question is typically nominalized using the interrogative operator ‘whether’ as in “The customer asked whether a car is available,” but is asked (in English) with no such operator: “Is a car available?”. The meaning of ‘whether’ in this context is “What truth-value does this proposition have?”. The formulation of such a question is a projection on a variable that ranges over a characteristic type (here called ‘truth-value’) whose instances are the characteristics ‘proposition is true’ and ‘proposition is false’. The projection is constrained by the truth-value being that of the proposition “a car is available” formulated using proposition nominalization.

Example: “Is a car available”?
 The question is meant by a closed projection.
 . The projection is on a unitary variable.
 . . The variable ranges over the concept ‘truth-value’.
 . The projection is constrained by a universal quantification.
 . . The universal quantification introduces a second unitary variable.

- ... The second variable ranges over the concept 'proposition'.
- ... The second variable is restricted by a proposition nominalization.
- ... The proposition nominalization binds to the second variable.
- ... The proposition nominalization considers an existential quantification.
- ... The existential quantification introduces a third variable.
- ... The variable ranges over the concept 'car'.
- ... The existential quantification scopes over an atomic formulation.
- ... The atomic formulation is based on the verb concept 'car is available'.
- ... The 'car' role is bound to the third variable.
- ... The universal quantification scopes over an atomic formulation.
- ... The atomic formulation is based on the verb concept 'proposition has truth-value'.
- ... The 'proposition' role is bound to the second variable.
- ... The 'truth-value' role is bound to the first variable.

Note:

An auxiliary variable of a closed projection that means a question is relevant to formulating the meaning of the question, but the question is answered without identifying referents of the auxiliary variable.

22 Index of Vocabulary Entries (Informative)

A

actuality 23
adopted definition 137
adopting authority 139
adopting authority adopts element of guidance from owning authority citing reference 140
advice 99
advice is derived from business policy 99
advice of contingency 110
advice of optionality 120
advice of permission 119
advice of possibility 110
advice statement 102
aggregation formulation 167
answer nominalization 172
antecedent 157
aspect 89
association 77
assortment 83
at-least-n quantification 161
at-least-n quantification has minimum cardinality 162
at-most-n quantification 162
at-most-n quantification has maximum cardinality 162
at-most-one quantification 162
atomic formulation 150
atomic formulation has role binding 150
atomic formulation is based on verb concept 151
attributive namespace 136
attributive namespace is for subject concept 136
attributive namespace is within vocabulary namespace 136
authority 41
authority authors guidance statement 139
authority defines element of guidance 139
authority has business jurisdiction over element of guidance 41
auxiliary variable 176

B

bag projection 176
behavioral business rule 117
behavioral business rule has enforcement level 119
behavioral business rule is violated 118
behavioral business rule statement 121
binary logical operation 156
binary logical operation has logical operand 1 156
binary logical operation has logical operand 2 156
binary verb concept 52
bindable target 149
body of shared concepts 126

- body of shared concepts includes concept 126
- body of shared guidance 127
- body of shared guidance includes element of guidance 127
- body of shared guidance includes rule set 127
- body of shared meanings 125
- body of shared meanings includes body of shared concepts 127
- body of shared meanings includes body of shared guidance 127
- body of shared meanings unites semantic community 126
- body of shared meanings¹ contains body of shared meanings² 126
- business policy 100
- business policy statement 102
- business rule 98
- business rule is derived from business policy 99
- business vocabulary 128

C

- cardinality 94
- categorization 80
- categorization scheme 81
- categorization scheme contains category 81
- categorization scheme is for general concept 81
- categorization type 81
- categorization type is for general concept 81
- category 45
- characteristic 43
- characteristic type 82
- characterization 83
- classification 82
- closed logical formulation 145
- closed logical formulation formalizes statement 146
- closed logical formulation means proposition 146
- closed projection 177
- closed projection defines noun concept 177
- closed projection defines verb concept 178
- closed projection formalizes definition 177
- closed projection means question 180
- closed semantic formulation 144
- closed semantic formulation formulates meaning 144
- comment 76
- communication content 133
- communication content is composed of representation 134
- community 39
- community has subcommunity 40
- community has URI 39
- complete rulebook 133
- concept 24
- concept has definition 73

concept has designation 61
concept has extension 30
concept has facet 89
concept has implied characteristic 45
concept has instance 31
concept has necessary characteristic 44
concept incorporates characteristic 44
concept of thing as composite 92
concept of thing as continuant 92
concept of thing as developed 92
concept of thing as occurrent 92
concept of thing as primitive 92
concept of thing as unitary 91
concept of thing existing dependently 92
concept of thing existing independently 92
concept type 81
concept1 is coextensive with concept2 31
concept1 specializes concept2 46
conjunction 156
consequent 157
Context of Thing 86
contextualized concept 86
contingency statement 114

D

definite description 74
definition 73
Definition Origin 137
definition serves as designation 74
definitional business rule 110
definitional rule 109
definitional rule statement 111
delimiting characteristic 45
derivable concept 74
description 75
description portrays meaning 75
descriptive example 75
descriptive example illustrates meaning 76
designation 60
designation context 59
designation has signifier 61
designation is implicitly understood 74
designation is in namespace 135
disjunction 156
document content 134

E

element 94
element of governance 100
element of governance is directly enforceable 100

- element of guidance 26
- element of guidance acknowledges as possible state of affairs 35
- element of guidance is practicable 99
- element of guidance makes impossible state of affairs 35
- element of guidance necessitates state of affairs 36
- element of guidance obligates state of affairs 36
- element of guidance permits state of affairs 35
- element of guidance prohibits state of affairs 37
- Elements of Concept System Structure 90
- enforcement level 119
- equivalence 157
- essential characteristic 44
- exactly-n quantification 162
- exactly-n quantification has cardinality 162
- exactly-one quantification 162
- exclusive disjunction 157
- existential quantification 161
- expression 20
- expression is unambiguous to speech community 58
- expression represents meaning 21
- extension 30
- extensional definition 74

F

- facet 89
- fact 26
- Formal Logic and Mathematics Vocabulary 17
- formal representation 58
- fundamental concept 85

G

- general concept 48
- general concept objectifies verb concept 84
- general verb concept 52
- guidance statement 101

I

- icon 62
- implication 157
- implication has antecedent 157
- implication has consequent 157
- implied characteristic 45
- impossibility statement 112

- inconsequent 158
- individual noun concept 49
- individual verb concept 52
- informal representation 58
- information source 134
- instance 31
- instantiation formulation 151
- instantiation formulation binds to bindable target 152
- instantiation formulation considers concept 152
- integer 94
- intensional definition 74
- intensional definition uses delimiting characteristic 74
- is-facet-of proposition 89
- ISO 1087-1 (English) 17
- ISO 6093 Number Namespace 17
- ISO 639-2 (Alpha-3 Code) 18
- ISO 639-2 (English) 18
- is-property-of verb concept 78
- is-role-of proposition 88

K

L

- language 40
- logical formulation 145
- logical formulation constrains projection 176
- logical formulation kind 145
- logical formulation restricts variable 147
- logical negation 157
- logical operand 156
- logical operand 1 156
- logical operand 2 156
- logical operation 155
- logical operation has logical operand 156

M

- maximum cardinality 161
- meaning 20
- meaning corresponds to thing 21
- message content 134
- minimum cardinality 161
- modal formulation 152
- modal formulation embeds logical formulation 153
- more general concept 45

N

- name 62

- namespace 135
- namespace has URI 135
- namespace1 incorporates namespace2 135
- nand formulation 158
- necessary characteristic 44
- necessity formulation 153
- necessity statement 111
- non-necessity statement 114
- non-obligation statement 124
- nonnegative integer 94
- nonverbal designation 62
- nor formulation 158
- note 76
- note comments on meaning 76
- noun concept 47
- noun concept nominalization 168
- noun form 68
- number 94
- numeric range quantification 163
- numeric range quantification has maximum cardinality 163
- numeric range quantification has minimum cardinality 163

O

- objectification 164
- objectification binds to bindable target 165
- objectification considers logical formulation 165
- objectified verb concept 84
- obligation formulation 153
- obligation statement 121
- operative business rule 118
- operative business rule statement 121
- optionality statement 124
- owned definition 137
- owning authority 140

P

- partitioning 81
- partitive verb concept 79
- part-whole verb concept 80
- permissibility formulation 154
- permission statement 123
- placeholder 65
- placeholder is at starting character position 69
- placeholder uses designation 70
- positive integer 94
- possibility formulation 154

possibility statement 113
preferred designation 63
prohibited designation 63
prohibition statement 122
projecting formulation 166
projecting formulation binds to bindable target 166
projecting formulation has projection 166
projection 174
projection has auxiliary variable 176
projection is on variable 175
projection position 176
property 22
property association 78
proposition 24
proposition corresponds to state of affairs 32
proposition is based on verb concept 51
proposition is false 33
proposition is necessarily true 34
proposition is obligated to be false 34
proposition is obligated to be true 34
proposition is permitted to be true 34
proposition is possibly true 34
proposition is true 33
proposition nominalization 170
proposition nominalization binds to bindable target 171
proposition nominalization considers logical formulation 171

Q

quantification 159
quantification introduces variable 160
quantification scopes over logical formulation 160
quantity 93
quantity1 equals quantity2 94
quantity1 is less than quantity2 94
question 25
question nominalization 171

R

reference 76
reference points to information source 134
reference scheme 53
reference scheme extensionally uses verb concept role 54
reference scheme is for concept 54
reference scheme simply uses verb concept role 54
reference scheme uses characteristic 55
reference supports meaning 76
remark 76
representation 57
representation formality 58
representation has expression 57
representation is in designation context 59

representation is in subject field 60
representation represents meaning 57
representation uses vocabulary 130
res 22
res is sensory manifestation of signifier 37
restricted permission statement 122
restricted possibility statement 112
role 48
role binding 151
role binding binds to bindable target 151
role ranges over general concept 48
rule set 127
rule set includes element of guidance 127
rule statement 102
rule 27
rulebook 132
rulebook has URI 133
ruleset 127

S

SBVR rulebook 133
SBVR Vocabulary 17, 19, 20
scope formulation 161
segmentation 81
semantic community 40
semantic community has speech community 40
semantic community shares understanding of concept 40
semantic formulation 144
sentential form 68
set 94
set has cardinality 95
set projection 176
signifier 61
situation 87
situational role 88
speech community 40
speech community adopts adopted definition citing reference 138
speech community determines speech community representation set 130
speech community owns owned definition 137
speech community owns vocabulary 129
speech community regulates its usage of signifier 63
speech community representation set 130
speech community representation set includes representation 130
speech community uses language 40
speech community uses vocabulary 129
starting character position 69
state of affairs 22
state of affairs involves thing in role 36

state of affairs is actual 23
statement 70
statement denotes state of affairs 38
statement expresses proposition 71
statement of advice of permission 123
statement of advice of possibility 113
structural business rule 110
structural rule 110
structural rule statement 111
subcommunity 40
subject concept 78
subject field 60

T

term 61
term denotes thing 37
terminological dictionary 131
terminological dictionary expresses body of shared meanings 132
terminological dictionary has URI 131
terminological dictionary includes representation 131
terminological dictionary presents vocabulary 132
text 28
thing 20
thing has name 37
thing is in set 94
thing1 is thing2 22

U

UML2 Infrastructure 18
unitary verb concept 52
Unicode Glossary 18
Uniform Resource Identifiers Vocabulary 18
unitary noun concept 49
unitary verb concept 52
universal quantification 161
URI 29

V

variable 146
variable has projection position 176
variable is free within semantic formulation 149
variable is unitary 147
variable maps to verb concept role 179
variable ranges over concept 147
verb concept 50
verb concept has role 51
verb concept has verb concept wording 67
verb concept nominalization 169
verb concept objectification 84

- verb concept role 51
- verb concept role designation 64
- verb concept role has role binding 151
- verb concept wording 66
- verb concept wording has placeholder 69
- verb concept wording incorporates verb symbol 67
- verb concept wording is in namespace 135
- verb symbol 62
- viewpoint 89
- vocabulary 128
- vocabulary is designed for speech community 129
- vocabulary is expressed in language 129
- vocabulary is used to express body of shared meanings 129
- vocabulary namespace 135
- vocabulary namespace is derived from vocabulary 135
- vocabulary namespace is for language 135
- vocabulary namespace is specific to designation context 136
- vocabulary namespace is specific to subject field 136
- Vocabulary Registration Vocabulary 17
- Vocabulary Registration Vocabulary 17
- vocabulary1 incorporates vocabulary2 129

W

- whether-or-not formulation 158
- whether-or-not formulation has consequent 158
- whether-or-not formulation has inconsequent 158

Part III - Transformation to XMI Metamodel and the Metamodel's Interpretation in Formal Logics

This part contains details on the transformation of the [SBVR Vocabulary](#) (Clauses 8 through 21) to the SBVR XMI metamodel. It also presents the formal logics interpretation of the SBVR XMI Metamodel.

Clause 23 specifies how the SBVR XMI Metamodel is generated from the Terminological entries in the [SBVR Vocabulary](#) and the [Vocabulary Registration Vocabulary](#) (Clauses 7 through 21).

Clause 24 presents the formal logics and mathematical underpinnings of the SBVR XML Metamodel. A concept in Clauses 8 through 21 marked with the symbol 'FL' is mapped to a formal logics concept in Clause 24.

Clause 25 lists supporting documents such as an SBVR XMI-based XML schema (XSD) for the SBVR XMI Metamodel.

23 SBVR's Use of MOF and XMI

23.1 General

This clause defines a transformation:

- from the *business* vocabulary text in the terminological entries in SBVR Clauses 7-21 which is created for use by the business people operating an organization.
- to a *data model*, i.e., the SBVR XMI Metamodel XML Schema (see 25.3) for SBVR Content Model Exchange Documents (see Clause 2).

The SBVR XMI Metamodel (see 25.2) is a serialization of the SBVR MOF Metamodel that specifies a CMOF representation of SBVR semantics in the SBVR XMI XML Schema (see Clause 25.3) data model for exchanging the content of SBVR Terminological Dictionaries and Rulebooks in SBVR Content Model Exchange XML Documents.

SBVR's use of MOF and how the SBVR MOF Metamodel handles certain semantic modeling challenges using MOF 2.n are described below. The SBVR MOF Metamodel is available in serialized form as the XML document, SBVR XMI Metamodel (see Clause 25.2). The SBVR MOF Metamodel is generated by the transformation specified in this Clause from the text of the Clauses 7 through 21 terminological entries. An example SBVR Content Model that instantiates the SBVR XMI Metamodel is then shown and explained (see Clause 23.5). Finally, the SBVR Content Model for SBVR (see Clause 23.6) is explained.

Models of business concepts, business vocabularies and business guidance can be communicated in terms of SBVR semantics using XML documents, i.e. "SBVR Content Model Exchange Documents", (see Clause 2) that conform to the "SBVR XMI XML Schema" (see Clause 25.3) created from the "SBVR XMI Metamodel" (see Clause 25.2). The Clause 25.4 "SBVR Content Model for SBVR" XML document is an example of an "SBVR Content Model Exchange Document" containing the terminological entry content of SBVR Clauses 7-21.

23.2 SBVR's Use of MOF

23.2.1 SBVR uses MOF as a syntax to represent SBVR semantics

SBVR's use of MOF imposes no MOF or UML semantics on SBVR content

The SBVR MOF Metamodel, its SBVR XMI Metamodel serialization, and the SBVR XMI XML Schema represent only SBVR semantics as defined in Clauses 7-21 with the MOF representations mapped to those definitions generally or specifically in Clause 23.3. That SBVR Terminological Dictionary and Rulebook content can be exchanged using the SBVR XMI XML Schema must not be read to imply that any MOF or UML semantics accrue to the SBVR content.

SBVR Terminological Dictionary and Rulebook content is not "meta"

SBVR Terminological Dictionary and Rulebook content documents the meaning of terms and other representations that business authors intend when they use them in their business communications, as evidenced in their written documentation, such as contracts, product/service specifications, and governance and regulatory compliance documents. Such documents are the authoritative source for the SBVR content.

SBVR content is not a model of anything external to people, whether physical or partially intangible such as an organization as a social system. Such content is a documentation of the meaning, i.e., concepts and propositions, about those things external to people and the representations used to express the meanings in natural language. SBVR content is best understood by analogy with business dictionaries and policy manuals.

One would never think of using a business dictionary, even if its meaning were 100% unambiguous, directly without a transformation as a data model or any kind of meta data. A dictionary simply documents the meanings people intend when they use the terms it defines to communicate. SBVR Clauses 1.4 and 1.5 are very clear on this.

MOF Reflection is prohibited in SBVR's use of MOF to represent SBVR semantics

Because, by its very nature, SBVR Terminological Dictionary and Rulebook content cannot be used directly in any "meta" kind of way, the normative SBVR use of MOF prohibits the use of MOF Reflection on any Instance Model created by using the SBVR XMI Metamodel as a metamodel in any tool.

In other words, MOF models and/or UML models containing SBVR Terminological Dictionary or Rulebook content can not be imported into any tool as a metamodel and that use be claimed to be conformant with the SBVR specification. SBVR Clause 1.5 is very clear that a transformation is required to bridge from SBVR Terminological Dictionary and Rulebook content to a data model, message model, model for business information, model for reasoning over business information or any other IT system model.

Definition of MOF Terms

The following terms used in this clause are not words defined by SBVR. Their meanings come from MOF 2.4.2 or UML 2.4.2.

- alias
- association
- association end
- attribute
- class
- data type
- data value
- element
- link
- metamodel
- model
- package

How each of these is used with respect to SBVR is explained in Clauses 23.2 and 23.3.

23.2.2 SBVR Content Models

An SBVR Content Model contains SBVR Terminological Dictionary and Rulebook content as data in an XML file that uses the SBVR XMI XML Schema as its XSD. The SBVR XMI XML Schema describes the structure and language by which the SBVR content is represented in an SBVR Content Model XML document.

XML text (*between XML Element tags; between double quotes in XML attributes*) in SBVR Content Model exchange documents is normatively Unicode UTF-8 as per the SBVR XMI Metamodel XML Schema (Clause 25.4). The entire UTF-8 character set is supported. As required by the XML standard, all XML text must use XML Entity References in place of each these five characters < > & ' " that occur within it.

SBVR Content Models contain representations of facts that document the meanings, representations and supporting information in SBVR Terminological Dictionaries and Rulebooks. For example, facts about EU-Rent's concepts, rules, their representations and their semantic formulations can be represented in an SBVR Content Model. An example SBVR

Content Model is shown in Using MOF to Represent Semantics below. SBVR Content Models are often incomplete representations of an SBVR Terminological Dictionary or Rulebook. The size of a model depends on what facts are being exchanged, which can be as little as a single fact.

One particular SBVR Content Model is the SBVR Content Model for SBVR (see Clause 25.4), which is the SBVR Terminological Dictionary for communicating about business vocabulary and business rules. It is described in Clause 23.5 below.

An SBVR Content Model instantiates the SBVR XMI XML Schema. It is exchanged as a [fact model](#), which combines a [conceptual schema](#), i.e. the SBVR XMI XML Schema (Clause 25.3) and a set of [facts](#), e.g. the SBVR Content Model for SBVR (Clause 25.4) that contains the terminological entries in Clauses 7-21.

All uses of the terms "[conceptual schema](#)" and "[fact model](#)" in this clause are as defined in Clause 24.2.2.1.

23.2.3 Transformation that creates SBVR machine-readable files

Source of the Transformation

All SBVR machine-readable files are generated from the natural language text in the SBVR terminological entries in the SBVR Vocabulary in Clauses 7-21. The SBVR Structured English styling of the SBVR terminological entries, as defined in Annex A, is used to map the content of the terminological entries to the SBVR concepts defined in Clauses 7-21.

Targets of the Transformation

The key target of the transformation, which is specified in Clause 23.3, is the SBVR MOF Metamodel in a UML modeling tool.

The SBVR MOF Metamodel does not include definitions, rules, notes, examples or semantic formulations. Rather, it mirrors the SBVR namespaces for the [SBVR Vocabulary](#) in Clauses 7-21. It provides a MOF means of expression (classes and associations) where the [SBVR Vocabulary](#) namespaces identify an English language means of expression (designations and verb concept wordings). Both use the same signifiers and express the same SBVR semantics. A result of this alignment of the SBVR MOF Metamodel with the [SBVR Vocabulary](#) is that the [SBVR Vocabulary](#) defines the SBVR meanings expressed by the SBVR MOF Metamodel. The SBVR MOF Metamodel is serialized as an XML document, SBVR XMI Metamodel (see 25.2).

From the SBVR MOF Metamodel in a UML modeling tool, two of the machine-readable files are generated:

- SBVR XMI Metamodel (Clause 25.2)
- SBVR XMI XML Schema (XSD) (Clause 25.3)

The SBVR Content Model for SBVR (Clause 25.4) is generated directly from the Clauses 7-21 terminological entries (see "Source of the Transformation") into the XML data structure specified by the SBVR XMI XML Schema (Clause 25.3).

Transformation Process

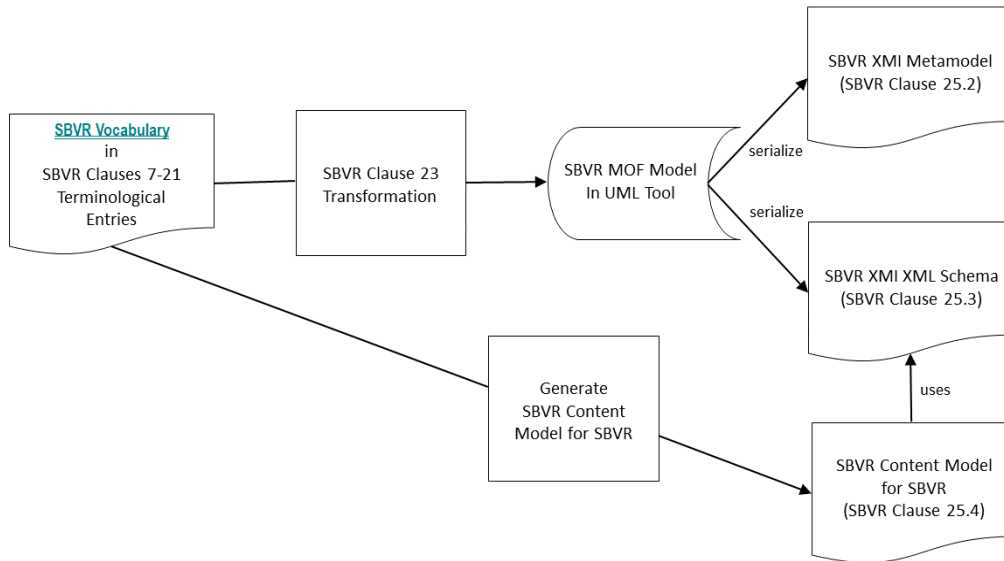

Figure 23.1 - SBVR Machine-Readable File Transformation

23.3 MOF Model Elements for SBVR

The [SBVR Vocabulary](#) is mapped to MOF elements that make up the SBVR MOF Metamodel. It should not be construed from this one-way mapping that a MOF class is the same thing as an SBVR concept or that there is any semantic equivalence between MOF and SBVR.

Both the mapping of the [SBVR Vocabulary](#) to MOF and the representation of SBVR model content using MOF are described below, divided using the following headings.

Heading	Purpose
<i>MOF Elements of the SBVR XMI Metamodel</i>	Prescriptive description of the mapping of the SBVR Vocabulary into a MOF-based metamodel
<i>Elements of SBVR Content Models</i>	Prescriptive description of how facts are represented within an SBVR Content model
<i>Rationale</i>	Design rationale explaining aspects of SBVR or MOF that led to the MOF representations described here

The MOF diagram patterns shown in this clause are the target patterns for the SBVR content represented using the SBVR MOF Metamodel as serialized in the SBVR XMI Metamodel (see 25.2) that is generated from the terminological entry text in Clauses 7-21 according to the transformations specified in this clause.

23.3.1 MOF Packages for SBVR Vocabulary Namespaces

MOF Elements of the SBVR MOF Metamodel

The [SBVR Vocabulary](#) is mapped to the SBVR MOF Metamodel, which is made up of one package, which is a MOF-based reflection of the [SBVR Vocabulary](#) namespace.

Elements of SBVR Content Models

The package that makes up the SBVR MOF Metamodel contain classes and associations.

Rationale

The SBVR MOF Metamodel package can be imported or merged into other MOF-based metamodels. For example, a metamodel of organizational structure can import the SBVR MOF Metamodel package as a starting point for modeling organization types and organizational roles. Similarly, a metamodel of business process can import the SBVR MOF Metamodel package in order to relate processes to rules, or for modeling semantic formulations of rules that govern processes.

23.3.2 MOF Classes for SBVR Noun Concepts

MOF Elements of the SBVR MOF Metamodel

Each designation in a vocabulary namespace for a noun concept that is not a role is mirrored in the SBVR XMI Metamodel as a class. The signifier of the designation is the name of the class. The signifier of each synonym of the designation is an alias for the class.

The metamodel includes generalizations between classes reflecting generalizations between the represented noun concepts. Each SBVR concept besides [‘thing’](#) specializes [‘thing’](#), so the classes have the class **‘thing’** as a superclass either directly or indirectly.

The classes in the metamodel that mirror the following concepts are abstract (isAbstract = true):

[actuality](#)

[binary logical operation](#)

[bindable target](#)

[closed semantic formulation](#)

[community](#)

[concept](#)

[expression](#)

[fact](#)

[logical formulation](#)

[logical operation](#)

[meaning](#)

[modal formulation](#)

[projecting formulation](#)

[quantification](#)

[res](#)
[semantic formulation](#)
[set](#)
[situation](#)
[state of affairs](#)
[thing](#)

Example Vocabulary:

[characteristic](#)
 General Concept: [verb concept](#)
 Synonym: [unary verb concept](#)

Figure:

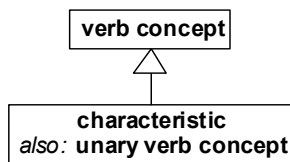

SBVR MOF Metamodel:

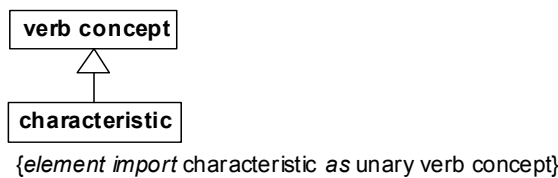

Elements of SBVR Content Models

Note that it is possible that two elements in an SBVR Content Model represent the same actual thing. Clause 23.4.1 explains situations where this is likely and tells how to relate the two elements within the SBVR Content Model. Also, a lack of an element in an SBVR Content Model implies nothing - it does not imply that something does not exist (see Clause 23.4.2 Open World Assumption).

An element of an abstract class exists in a MOF-based model only by instantiating a nonabstract subclass of that abstract class.

Rationale

Use of aliasing, though not common in MOF-based metamodels, keeps a strong alignment of the SBVR MOF Metamodel with the [SBVR Vocabulary](#).

The SBVR MOF metamodel is intended to provide for representing meanings and their representations. It is not intended for representing things in general. Making some classes abstract simplifies interpretation of SBVR Content models by limiting them to SBVR's scope.

Each case of an objectification involves the verb concept objectified, the noun concept objectifying it along with terminological content that specifies the connection. Each of the two concepts is represented separately in the SBVR MOF Metamodel.

23.3.3 MOF Boolean Attributes for SBVR Characteristics

MOF Elements of the SBVR MOF Metamodel

A characteristic is represented in MOF as an optional Boolean attribute as shown below.

Example Vocabulary:

variable is unitary

Figure:

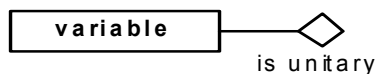

SBVR MOF Metamodel:

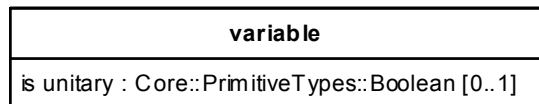

Elements of SBVR Content Models

For an element in an SBVR Content model, the meaning of the value TRUE is that the characteristic is attributed to the thing represented by the element. A meaning of FALSE is that the thing represented by the element does not have the characteristic. A meaning of the attribute being null is the same as the attribute being unspecified for the element.

Rationale

The attribute is optional in support of the Open World Assumption, explained in Clause 23.4.2.

23.3.4 MOF Associations for SBVR Binary Verb Concepts

MOF Elements of the SBVR MOF Metamodel

Each binary verb concept is represented in MOF terms as an association. Association names match verb concept wordings. If a verb concept has only one verb concept wording, the association's name is the expression of that verb concept wording, but with subscripts raised to normal text. The names of the association's ends are the placeholder expressions from the verb concept wording. The ends are owned by the association so that individual links can be serialized using XMI.

In cases of more than one verb concept wording (synonymous forms), one is chosen to name the association that does not imply a designation in an attributive namespace. Then there is an alias for the association for each other verb concept wording that has matching placeholder expressions (which implies matching association end names).

Including the names of an association's ends in the association's name makes the association's name unique within a package, as required by MOF.

In cases where an association's ends both connect to the same class, subscripts are used on placeholders to distinguish them. In the association name and its ends' names the subscripts are raised to normal text and serve to distinguish the ends.

Example Vocabulary:

concept₁ specializes concept₂
 Synonymous Form: concept₂ generalizes concept₁

Figure:

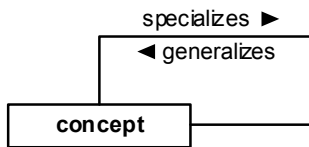

SBVR MOF Metamodel:

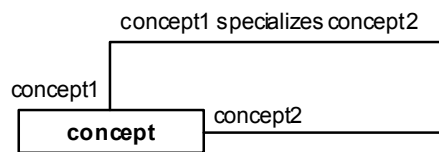

{element import concept1 specializes concept2 as concept2 generalizes concept1}

Some definitional rules impose multiplicity constraints for binary verb concepts. These are formally-stated restrictions on multiplicity in a definition or a definitional rule in the SBVR terminological entries (Clauses 7-21) and are included in the SBVR MOF Metamodel. If no multiplicity restriction is specified in the SBVR terminological entries, the implied multiplicity of “no minimum and/or maximum restriction” in the SBVR terminological entries is made explicit in the SBVR MOF Metamodel using the multiplicity “0..*”.

Annex A.2.1.1 documents the SBVR Structured English keywords that are used for the expression of multiplicities in SBVR terminological entries. The following table shows those keywords along with the corresponding multiplicity in the SBVR MOF Metamodel.

<i>SBVR Structured English Keyword</i>	<i>Kind of Logical Formulation</i>	<i>UML Multiplicity</i>
at least one	existential quantification	1..*
at least <i>n</i>	at-least-n quantification	<i>n</i> ..*
at most one	at-most-one quantification	0..1
at most <i>n</i>	at-most-n quantification	0.. <i>n</i>
exactly one	exactly-one quantification	1..1
exactly <i>n</i>	exactly-n quantification	<i>n</i> .. <i>n</i>
at least <i>n</i> and at most <i>m</i>	numeric range quantification	<i>n</i> .. <i>m</i>
more than one	at-least-n quantification with n = 2	2..*

Elements of SBVR Content Models

Where an association represents a binary verb concept, a link of the association within an SBVR Content model represents a [fact](#) of that binary verb concept. The absence of a link implies nothing. There are no defaults.

Rationale

All association ends in the SBVR MOF metamodel are noncomposite.

23.3.5 MOF Attributes for SBVR Roles of Verb Concepts

MOF Elements of the SBVR MOF Metamodel

A role of a binary verb concept that has a designation in an attributive namespace is understood in MOF terms as an attribute owned by the subject class. Such designations appear as names on association ends. In the example below, ‘element’ is in an attributive namespace for the concept ‘set,’ so it is mirrored in the SBVR MOF Metamodel as an attribute.

Example Vocabulary:

[thing is in set](#)

Synonymous Form: [set includes thing](#)

Synonymous Form: [set has element](#)

Figure:

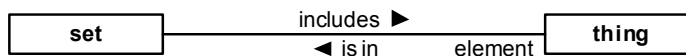

SBVR MOF Metamodel:

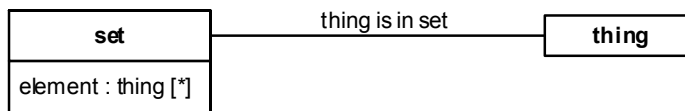

{element import thing is in set as set includes thing}

In each case where an attribute and an association end represent the same role, the SBVR MOF Metamodel includes a tag that tags both the attribute and the association end. The tag connects them to show their correlation. The tag’s name is “org.omg.sbvr.sameRole,” its value is "" (the empty string), and its elements are the attribute and the association end.

Where structural rules impose multiplicity constraints, they are included in the SBVR MOF Metamodel for association ends and for attributes.

Elements of SBVR Content Models

Where a role of a binary verb concept is understood in MOF terms as an attribute, specification of the attribute for an element in an SBVR Content model represents the entire extension of that verb concept for the element. There are no defaults. If the attribute is unspecified for an element, it is simply unspecified; it is not presumed by default to have no value. If anything is specified, all values of the attribute are specified. Specification that the attribute is null means there is no instance of the verb concept for the element.

Rationale

The attributes described in the sub clause are in addition to the associations that represent the binary verb concepts - the reason for the distinction is explained below.

To preserve ‘set’ semantics, any two values of the same attribute of the same element in an SBVR Content Model represent two different things. Where an attribute has two or more values, it can be concluded that each of the values represents a thing that is distinct from the others.

23.3.6 MOF Classes for SBVR Ternary Verb Concepts

MOF Elements of the SBVR MOF Metamodel

Each ternary verb concept is represented in MOF terms as a class with one single-valued, required attribute for each role of the verb concept. The class's name takes the same form as the name of an association for a binary verb concept. If there are multiple verb concept wordings for a ternary verb concept, aliases are used.

Example Vocabulary:

state of affairs involves thing in role

Figure:

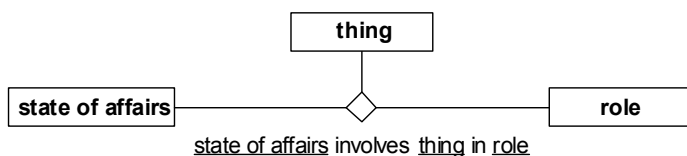

SBVR MOF Metamodel:

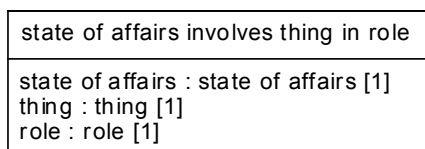

Elements of SBVR Content Models

In an SBVR Content model, an element of such a class represents a fact of the ternary verb concept.

23.3.7 Data Values

MOF Elements of the SBVR MOF Metamodel

The classes ‘text’ and ‘integer,’ representing ‘text’ and ‘integer,’ have data attributes shown below.

SBVR MOF Metamodel:

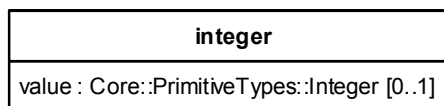
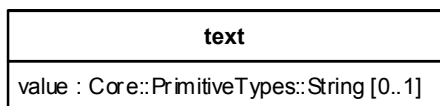

Elements of SBVR Content Models

If one of these attributes is specified in an SBVR Content model, the represented text or integer is the specified value. Specification of null is equivalent to not specifying anything. There are no defaults.

The concepts ‘[text](#)’, ‘[integer](#)’, and ‘[number](#)’ are SBVR noun concepts, so their instances can be represented like instances of other noun concepts (see 23.2.2 MOF classes for SBVR Noun Concepts) without using the ‘value’ attributes shown above. A specific number can be identified by a designation. The [ISO 6093 Number Namespace](#) includes designations of all integers and of numbers with decimal places. Each designation in the [ISO 6093 Number Namespace](#) shall be interpreted according to [ISO 6093].

Each text value is a Unicode string of undefined length and is considered without regard to markup.

Rationale

The attributes are optional because SBVR allows that texts and integers, like other kinds of things, can be described by [facts](#) without necessarily being identified. Also, the data types ‘String’ and ‘Integer’ in MOF have size limitations, so the attributes cannot be used for all cases. To refer to a string or integer that is beyond the MOF limitations, a model can identify the string or integer using [facts](#) about it that satisfy a reference scheme. For example, the number 999999999999 can be identified as having a designation in the [ISO 6093 Number Namespace](#) with the signifier “999999999999”.

23.3.8 XMI Names

MOF Elements of the SBVR MOF Metamodel

A named element is tagged with an ‘org.omg.xmi.xmiName’ tag if its XMI name differs from its MOF name. XMI names are determined from MOF names by upcasing each character that follows a blank and then removing the blank. The names, because they come from the SBVR vocabularies, do not contain any characters that are invalid in XML identifiers.

23.4 Using MOF to Represent Semantics

The SBVR MOF Metamodel is a direct representation of the meanings in the [SBVR Vocabulary](#), which also represents SBVR meanings, but this direct representation of SBVR meanings requires two semantic modeling capabilities not directly provided by MOF 2.n. The two following clauses explain how the two capabilities, multiclassification and the Open World Assumption, are supported by the SBVR MOF Metamodel.

23.4.1 Multiclassification

MOF 2.0 requires that each element is described by one class (its “metaClass”). Sometimes a thing cannot be represented by an element of a single class. This happens when a thing is an instance of multiple concepts, neither one specializing the other. To represent this case, multiple elements are used, one per concept. A link of the association ‘**thing1 is thing2**’ (representing the verb concept ‘[thing₁ is thing₂](#)’) is used to indicate that the multiple elements represent the same thing. A consumer of a model in which two elements represent the same thing should assume that a fact represented in reference to either element applies to both elements (since they both represent the same thing).

As an example, consider the noun concepts ‘[closed logical formulation](#)’ and ‘[obligation formulation](#).’ Neither specializes the other. Where an obligation formulation is a closed formulation that formulates a proposition, a model uses one element of type ‘**closed logical formulation**’ and a separate element of type ‘**obligation formulation**’ along with a ‘**thing1 is thing2**’ link that says the two elements represent the same thing.

23.4.2 Open World Assumption

See Clause 24.2.1.3 Open/Closed World Semantics for the SBVR interpretation of this topic in formal logic. This clause specifies that SBVR Content Model exchange documents always have an Open World Assumption.

The open world assumption is that representation of [facts](#) in a model does not imply that those are the only [facts](#) of a particular type nor that they are the only [facts](#) of a particular type about a subject thing - there are no implications to be taken from what is not represented in a model. For example, consider [facts](#) about a set S. The two [facts](#), “1 is in S” and “2 is in S,” do not convey the same meaning as “S = {1, 2}” because the two [facts](#) do not imply anything about whether other things are in S.

In general, SBVR Content Models represent [facts](#) with an open world assumption. But some reference schemes use roles of binary verb concepts extensionally (see Clause 11.3 [reference scheme extensionally uses verb concept role](#)), so models represent a complete extension with respect to a subject thing being identified.

MOF supports the open world assumption about instantiation of classifiers (classes and associations). MOF’s attributes support representation of an entire extension of an attribute with respect to a given subject. In order to enable a clear distinction in a model between individual [facts](#) and complete extensions with respect to a subject, association links are used to represent individual [facts](#) of a binary verb concept while attributes are used when identifying a complete extension of a binary verb concept with respect to a particular subject. This means that a [fact](#) can in one model be represented by a link, and in another by a value of an attribute of an element. The [fact](#) is represented using an attribute only when the complete extension of the verb concept is being represented for the subject. Examples of both cases appear in the example below. SBVR has a designation in an attributive namespace for every role that is extensionally used by a reference scheme such that the SBVR MOF Metamodel has the required attributes to satisfy all of SBVR’s reference schemes.

23.5 Example SBVR Content Model

Consider the following example, which includes a small portion of a vocabulary and a rule statement.

company

officer

company appoints officer

EU-Rent

General Concept: company

EU-Rent must appoint at least 3 officers.

The following figure is a UML instance diagram showing an SBVR Content model of the example. Some end names are elided where they are obvious from the class names or for ‘**thing1 is thing2**’ (where it makes no difference). For elements of the vocabulary, the three layers of expression, representation, and meaning are apparent in the diagram. The rule, shown at the bottom, connects to the meanings of the elements of the vocabulary though its logical formulation.

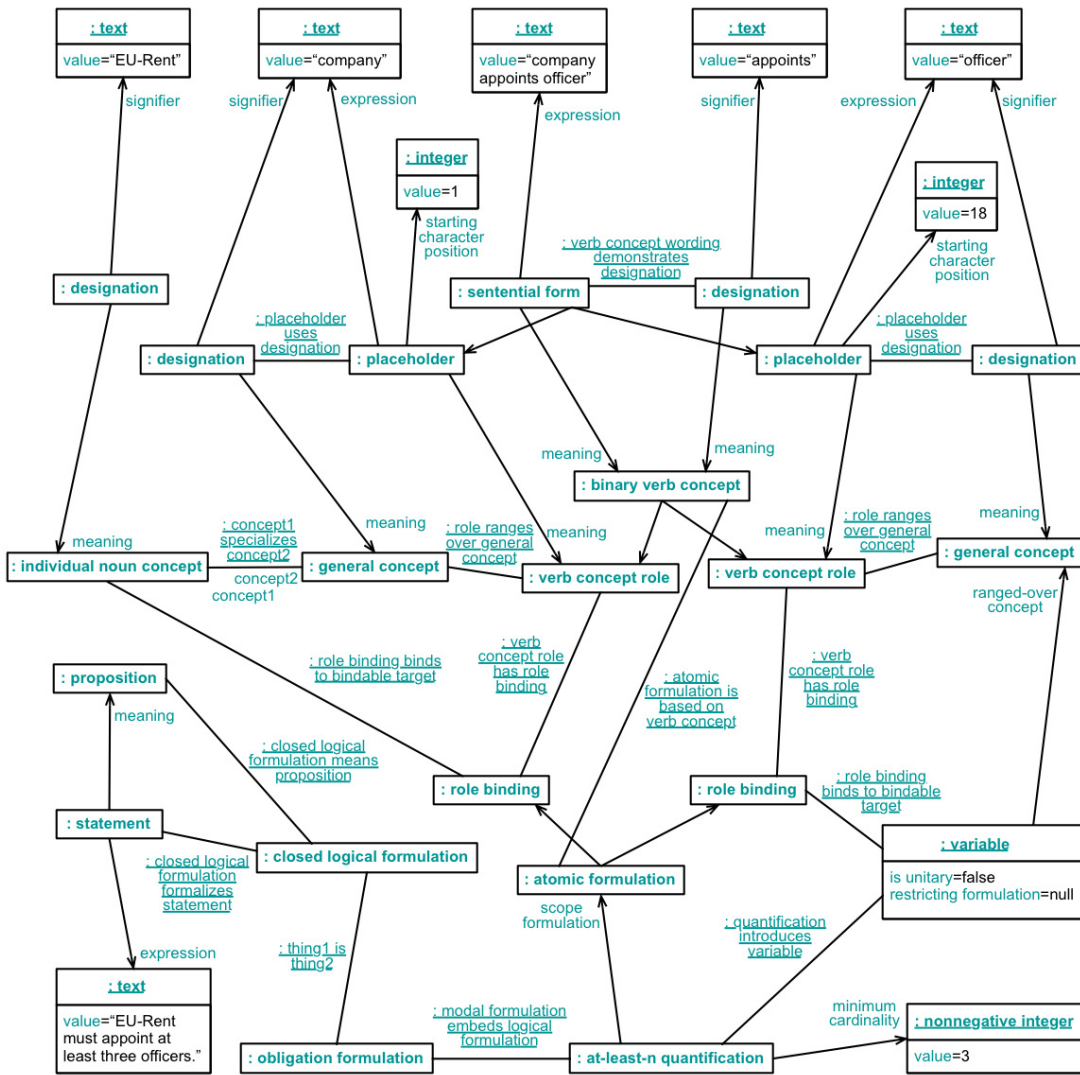

The example SBVRContent model is expressed below in XML based on the SBVR XMI XML Schema. The xmi:id values are arbitrary and have no special meaning, but they build on the related signifiers to help readability. The XML tags, which include the namespace prefix 'sbvr', are the XMI names for model elements of the SBVR XMI Metamodel.

```
<?xml version="1.0" encoding="UTF-8" ?>
<xmi:XML xmi:version="2.1" xmlns:xmi="http://schema.omg.org/spec/XMI/2.1"
  xmlns:sbvr="http://www.omg.org/spec/SBVR/20070901/SBVR.xml">
```

For 'company':

```
<sbvr:designation xmi:id="company" signifier="company-t" meaning="company-c"/>
<sbvr:generalConcept xmi:id="company-c"/>
<sbvr:text xmi:id="company-t" value="company"/>
```

For ‘officer’:

```
<sbvr:designation xmi:id="officer" signifier="officer-t" meaning="officer-c"/>
<sbvr:generalConcept xmi:id="officer-c"/>
<sbvr:text xmi:id="officer-t" value="officer"/>
```

For ‘company appoints officer’:

```
<sbvr:sententialForm xmi:id="companyAppointsOfficer" expression="cao-t" meaning="cao-c" placeholder="cao-p1 cao-p2"/>
<sbvr:binaryVerbConcept xmi:id="cao-c" role="cao-r1 cao-r2"/>
<sbvr:verbConceptWordingIncorporatesVerbSymbol verbConceptWording="companyAppointsOfficer" verbSymbol="appoints"/>
<sbvr:designation xmi:id="appoints" signifier="appoints-t" meaning="cao-c"/>
<sbvr:text xmi:id="cao-t" value="company appoints officer"/>
<sbvr:text xmi:id="appoints-t" value="appoints"/>
```

```
<sbvr:placeholder xmi:id="cao-p1" expression="company-t" startingCharacterPosition="i1" meaning="cao-r1"/>
<sbvr:placeholderUsesDesignation placeholder="cao-p1" designation="company"/>
<sbvr:roleRangesOverObjectType role="cao-r1" generalConcept="company-c"/>
<sbvr:verbConceptRole xmi:id="cao-r1"/>
<sbvr:positiveInteger xmi:id="i1" value="1"/>
```

```
<sbvr:placeholder xmi:id="cao-p2" expression="officer-t" startingCharacterPosition="i18" meaning="cao-r2"/>
<sbvr:placeholderUsesDesignation placeholder="cao-p2" designation="officer"/>
<sbvr:roleRangesOverObjectType role="cao-r2" generalConcept="officer-c"/>
<sbvr:verbConceptRole xmi:id="cao-r2"/>
<sbvr:positiveInteger xmi:id="i18" value="18"/>
```

For ‘EU-Rent’ with “General Concept: company”:

```
<sbvr:designation xmi:id="EU-Rent" signifier="EU-Rent-t" meaning="EU-Rent-c"/>
<sbvr:individualConcept xmi:id="EU-Rent-c"/>
<sbvr:text xmi:id="EU-Rent-t" value="EU-Rent"/>
<sbvr:concept1SpecializesConcept2 concept1="EU-Rent-c" concept2="company-c"/>
```

For “EU-Rent must appoint at least 3 officers”:

```
<sbvr:statement xmi:id="stmt" expression="stmt-t" meaning="stmt-p"/>
<sbvr:text xmi:id="stmt-t" value="EU-Rent must appoint at least 3 officers"/>
<sbvr:proposition xmi:id="stmt-p"/>
<sbvr:closedLogicalFormulationFormalizesStatement closedLogicalFormulation="ob2" statement="stmt"/>
<sbvr:closedLogicalFormulationMeansProposition closedLogicalFormulation="ob2" proposition="stmt-p"/>
<sbvr:obligationFormulation xmi:id="ob"/>
<sbvr:closedLogicalFormulation xmi:id="ob2"/>
<sbvr:thing1IsThing2 thing1="ob" thing2="ob2"/>
<sbvr:modalFormulationEmbedsLogicalFormulation modalFormulation="ob" logicalFormulation="am3"/>
<sbvr:at-least-nQuantification xmi:id="am3" scopeFormulation="atom" minimumCardinality="i3"/>
<sbvr:quantificationIntroducesVariable quantification="am3" variable="v"/>
<sbvr:variable xmi:id="v" ranged-overConcept="officer-c" restrictingFormulation="" isUnitary="false"/>
<sbvr:atomicFormulation xmi:id="atom" roleBinding="bind1 bind2"/>
<sbvr:atomicFormulationIsBasedOnverbConcept atomicFormulation="atom" verbConcept="cao-c"/>
<sbvr:roleBinding xmi:id="bind1"/>
<sbvr:roleBindingBindsToBindableTarget roleBinding="bind1" bindableTarget="EU-Rent-c"/>
```

```

<sbvr:verbConceptRoleHasRoleBinding verbConceptRole="cao-r1" roleBinding="bind1"/>
<sbvr:roleBinding xmi:id="bind2"/>
<sbvr:roleBindingBindsToBindableTarget roleBinding="bind2" bindableTarget="v"/>
<sbvr:verbConceptRoleHasRoleBinding verbConceptRole="cao-r2" roleBinding="bind2"/>
<sbvr:positiveInteger xmi:id="i3" value="3"/>

```

```
</xmi:XML>
```

The example shows some of the points explained previously about SBVR Content models.

- Fact Model - the entire XML content represents a [fact model](#), which is a combination of a [conceptual schema](#) and a set of facts. The conceptual schema of the fact model is identified in the heading where it says, `xmlns:sbvr="http://www.omg.org/spec/SBVR/20070901/SBVR.xml."` The URL identifies a document that serializes the SBVR Content Model for SBVR, which describes the concepts and rules that make up the conceptual schema (see 23.4 and 25.4). The elements of the XML content represent the set of facts of the fact model.
- Multiclassification - There is an occurrence of 'thing1IsThing2' which is used to connect a pair of elements that represent the same thing. There is an element of type 'obligationFormulation' (xmi:id="ob") and another element of type 'closedLogicalFormulation' (xmi:id="ob2"). Neither type specializes the other so there is one element of each type and a 'thing1IsThing2' link indicates that the two elements represent the same thing.
- Open World Assumption - Links, rather than attributes, are always used where there is an open world assumption, such as for the fact that the individual noun concept 'EU-Rent' specializes the concept 'company' - there is no indication that these concepts are not involved in other specializations.
- Attributes giving Complete Extensions for a Subject - Each specification of an attribute occurs where the entire extension of the attribute is being specified for a subject thing, such as for identifying the two placeholders of the verb concept wording 'company appoints officer' or the two roles of the verb concept. The one 'variable' in the example is serialized with "restrictingFormulation="" representing that it has no restricting formulation. In a number of cases, attributes are unspecified because the entire extension of the attribute for an element is not being specified. For example, the attribute 'representation' is unspecified for the elements representing meanings (e.g., 'company-c' and 'officer-c' - there can be any number of representations of a meaning, and the example model does not specify them all. However, each representation has exactly one meaning, so the 'meaning' attribute is specified for each representation to identify its one meaning.

23.6 The SBVR Content Model for SBVR

The SBVR Content Model for SBVR represents [facts](#) concerning all of the formally captioned contents of Clauses 7 through 12. In general, this includes all of the information given in the SBVR specification about its concepts that can be represented in terms of the SBVR MOF Metamodel. This includes:

- noun concepts and their designations
- verb concepts and their verb concept wordings
- specializations/generalizations
- concept types
- definitions and, where formal, their semantic formulations
- necessity statements and, where formal, their semantic formulations
- vocabularies, language, namespaces and their URIs
- notes, examples, sources, descriptions

The SBVR Content Model for SBVR is like the example in Clause MOF Model Elements for SBVR above except that it is about SBVR's vocabulary and meanings, not EU-Rent's. The complete SBVR Content Model for SBVR is serialized as XML documents listed in 25.4. It can be used and extended by other SBVR Content models that build on SBVR's concepts.

23.7 XMI for the SBVR Model of SBVR

XML patterns are shown below for the various parts of vocabulary descriptions and vocabulary entries used in Clauses 7 through 12. These patterns are used to create the XML documents that serialize the SBVR Content Model for SBVR. Each pattern is shown for a corresponding SBVR Structured English entry (see Annex A for entry descriptions).

The XML patterns provide a normative definition of which SBVR concepts are represented by each use of SBVR Structured English in the vocabulary descriptions and entries contained in Clauses 7 through 21.

The general principles used for the patterns are these: First, the [facts](#) of what is presented using SBVR Structured English are represented using XML. Second, for the objects referenced by those [facts](#), further [facts](#) are represented to satisfy reference schemes for those objects wherever sufficient detail is given. The principles are applicable to SBVR-based communication in general. The XML files identified in sub clause 23.3, which are created based on these principles following the patterns below, are examples of XML serializations of SBVR Content models.

The xmi:id values used in the patterns below are replaced by different values in the actual XML documents because the multitude of repetitions of the patterns need their own unique xmi:id values. But the xmi:id values shown below consistently and correctly show relationships within the patterns. Most xmi:id values are referenced only locally within the XML elements for the same Structured English entry, but some are referenced beyond that scope and are shown in bold blue (e.g., "[vocabulary](#)") so that references to them are easily followed. The different types of vocabulary entries (term, name and verb concept wording) are mutually exclusive. They each introduce an xmi:id value "[meaning](#)" which is referenced in other patterns.

Made-up names (e.g., "[Xyz Vocabulary](#)"), terms (e.g., "[example term](#)") and verb concept wordings (e.g., "[example is seen](#)") are used to show the patterns and to show how signifiers and other expressions appear in XML. Certain assumptions are made by the patterns based on the way the vocabularies in Clauses 7 through 12 are interrelated. The patterns assume that a vocabulary being described has a name in the [Vocabulary Registration Vocabulary](#) (of Clause 7). The patterns assume that where a term or name is used with a formal interpretation in Structured English, that term or name is found by way of the vocabulary namespace derived from the vocabulary being described. These assumptions are correct regarding Clauses 7 through 12, but they cannot necessarily be assumed about all vocabulary descriptions.

Each pattern has a part that remains unchanged for the kind of entry or caption shown (except for differences in xmi:id values as described above) and a part that varies based on the content of the entry. The part that varies is shown in **bold italics**. It can be a text or integer value, a quoted xmi:id of an object introduced elsewhere, or an XML tag.

The final XML documents created from the vocabulary clauses can differ slightly from what is exactly produced from the templates, but the represented meaning does not differ. In cases where two objects are created and then connected by a 'thing1IsThing2' link, the objects can be combined into one if they are of the same class or if one class specializes the other. In cases where the patterns would create two identical XML elements, only one is actually created. For example, all uses of an element for the integer 1 can use the same element.

23.7.1 XML Patterns for Vocabularies

[Xyz Vocabulary](#)

```
<sbvr:vocabulary xmi:id="vocabulary"/>
```

```

<sbvr:nameReferencesThing thing="vocabulary" name="XyzVocabulary"/>
<sbvr:name xmi:id="XyzVocabulary" signifier="v-s" meaning="vocabulary-concept"/>
<sbvr:individualConcept xmi:id="vocabulary-concept" instance="vocabulary"/>
<sbvr:text xmi:id="v-s" value="Xyz Vocabulary"/>
<sbvr:designationInNamespace designation="XyzVocabulary" namespace="vocabularyRegistrationNamespace"/>
<sbvr:vocabularyNamespace xmi:id="vocabularyNamespace"/>
<sbvr:vocabularyNamespacesDerivedFromVocabulary vocabularyNamespace="vocabularyNamespace" vocabulary="vocabulary"/>

```

The pattern above assumes the [Vocabulary Registration Vocabulary](#) has a vocabulary namespace like this:

```

<sbvr:vocabularyNamespace xmi:id="vocabularyRegistrationNamespace"/>

```

Included Vocabulary: [Abc Vocabulary](#)

```

<sbvr:vocabulary1IncorporatesVocabulary2 vocabulary1="vocabulary" vocabulary2="Abc"/>
<sbvr:namespace1IncorporatesNamespace2 namespace1="vocabularyNamespace" namespace2="Abc-ns"/>

```

The pattern above assumes there is a vocabulary named [Abc Vocabulary](#) like this:

```

<sbvr:vocabulary xmi:id="Abc"/>
<sbvr:vocabularyNamespace xmi:id="Abc-ns"/>

```

Language: [English](#)

```

<sbvr:language xmi:id="language"/>
<sbvr:vocabularyNamespacesForLanguage vocabularyNamespace="vocabularyNamespace" language="language"/>
<sbvr:nameReferencesThing thing="language" name="English"/>
<sbvr:name xmi:id="English" signifier="l-s" meaning="l-c"/>
<sbvr:individualConcept xmi:id="l-c" instance="language"/>
<sbvr:text xmi:id="l-s" value="English"/>
<sbvr:designationInNamespace designation="English" namespace="ISO639-2English"/>
<sbvr:vocabularyNamespace xmi:id="ISO639-2English"/>
<sbvr:namespaceHasURI namespace="ISO639-2English" URI="lm-u"/>
<sbvr:URI xmi:id="lm-u"
  value="http://www.loc.gov/standards/iso639-2/php/English_list.php"/>

```

Namespace URI: <http://some.uri>

```

<sbvr:namespaceHasURI namespace="vocabularyNamespace" URI="vn-uri"/>
<sbvr:URI xmi:id="vn-uri" value="http://some.uri"/>

```

Speech Community: [English Mechanics](#)

```

<sbvr:speechCommunityOwnsVocabulary speechCommunity="em" vocabulary="vocabulary"/>
<sbvr:conceptHasInstance concept="em-concept" instance="em"/>
<sbvr:speechCommunity xmi:id="em"/>

```

It is assumed for this entry that there is a name '[English Mechanics](#)' for an individual noun concept like this:

```

<sbvr:name xmi:id="em-name" signifier="em-s" meaning="em-concept"/>
<sbvr:individualConcept xmi:id="em-concept"/>
<sbvr:text xmi:id="em-s" value="English Mechanics"/>

```

The captions “Description:”, “Note:” and “Source:” are handled for a vocabulary in the same way as for terms within a vocabulary, as shown below, except that the related meaning is given as meaning="vocabulary-concept".

23.7.2 XML Patterns for General Concepts

example term

```
<sbvr:term xmi:id="exampleTerm" signifier="et-s" meaning="meaning"/>
<sbvr:generalConcept xmi:id="meaning"/>
<sbvr:text xmi:id="et-s" value="example term"/>
<sbvr:thingsInSet set="vocabulary" thing="exampleTerm"/>
<sbvr:designationInNamespace designation="exampleTerm" namespace="vocabularyNamespace"/>
```

If there is no “See:” caption, then the following is included:

```
<sbvr:preferredDesignation xmi:id="exampleTermPreferred"/>
<sbvr:thing1IsThing2 thing1="exampleTermPreferred" thing2="exampleTerm"/>
```

Concept Type: [role](#)

```
<sbvr:role xmi:id="meaningAsRole"/>
<sbvr:thing1IsThing2 thing1="meaningAsRole" thing2="meaning"/>
```

The pattern above is used if the concept type is an SBVR concept. The pattern below is used if the concept type is not an SBVR concept.

Concept Type: [example type](#)

```
<sbvr:conceptHasInstance concept="exampleType-c" instance="meaning"/>
```

There is assumed to be a term ‘[example type](#)’ for a general concept like this:

```
<sbvr:term xmi:id="exampleType" signifier="exampleType-s" meaning="exampleType-c"/>
<sbvr:generalConcept xmi:id="exampleType-c"/>
<sbvr:text xmi:id="exampleType-s" value="example type"/>
```

Definition: [example that is seen](#)

```
<sbvr:definition xmi:id="def-formal" expression="def-formal-e" meaning="meaning"/>
<sbvr:text xmi:id="def-formal-e" value="example that is seen"/>
<sbvr:concept1SpecializesConcept2 concept1="meaning" concept2="example-concept" />
<sbvr:closedProjectionFormalizesDefinition closedProjection="def-formal-projection" definition="def-formal"/>
<sbvr:closedProjectionDefinesNounConcept closedProjection="def-formal-projection" nounConcept="meaning"/>
```

The closed projection of the definition (not shown) has xmi:id="def-formal-projection". It is assumed for this entry and several others that there is a term ‘[example](#)’ for a general concept like this:

```
<sbvr:term xmi:id="example" signifier="example-s" meaning="example-concept"/>
<sbvr:generalConcept xmi:id="example-concept"/>
<sbvr:text xmi:id="example-s" value="example"/>
```

Definition: [example that](#) shows something

```
<sbvr:definition xmi:id="def-semiformal" expression="def-semiformal-e" meaning="meaning"/>
<sbvr:text xmi:id="def-semiformal-e" value="example that shows something"/>
<sbvr:concept1SpecializesConcept2 concept1="meaning" concept2="example-concept" />
```

Definition: whatever demonstrates

```
<sbvr:definition xmi:id="def-informal" expression="def-informal-e" meaning="meaning"/>
<sbvr:text xmi:id="def-informal-e" value="whatever demonstrates"/>
```

Description: A description of something

```
<sbvr:descriptionPortraysMeaning description="desc" meaning="meaning"/>
```



```
<sbvr:description xmi:id="desc" expression="desc-e"/>
<sbvr:text xmi:id="desc-e" value="A description of something"./>
```

Dictionary Basis: example
 None

Example: An example of an example
<sbvr:descriptiveExampleIllustratesMeaning descriptiveExample="de" meaning="meaning"/>
<sbvr:descriptiveExample xmi:id="de" expression="de-e"/>
<sbvr:text xmi:id="de-e" value="An **example of an example**"./>

General Concept: [example](#)
<sbvr:concept1SpecializesConcept2 concept1="meaning" concept2="example-concept" />

Necessity: Each [example is seen](#).
<sbvr:statement xmi:id="nec-stmt" expression="nec-e" meaning="nec"/>
<sbvr:text xmi:id="nec-e" value="Each **example is seen**"./>
<sbvr:proposition xmi:id="nec" isNecessarilyTrue="true"/>
<sbvr:closedLogicalFormulationFormalizesStatement closedLogicalFormulation="nec-formulation" statement="nec-stmt"/>
<sbvr:closedLogicalFormulationMeansProposition closedLogicalFormulation="nec-formulation" proposition="nec"/>

A closed logical formulation of the statement (not shown) has xmi:id="nec-formulation".

Note: This note says little.
<sbvr:noteCommentsOnMeaning note="note" meaning="meaning"/>
<sbvr:note xmi:id="note" expression="note-e"/>
<sbvr:text xmi:id="note-e" value="This **note says little**"./>

Possibility: Some [example is seen](#).
<sbvr:statement xmi:id="pos-stmt" expression="pos-e" meaning="pos"/>
<sbvr:text xmi:id="pos-e" value="Some **example is seen**"./>
<sbvr:proposition xmi:id="pos" isPossiblyTrue="true"/>
<sbvr:closedLogicalFormulationFormalizesStatement closedLogicalFormulation="pos-formulation" statement="pos-stmt"/>
<sbvr:closedLogicalFormulationMeansProposition closedLogicalFormulation="pos-formulation" proposition="pos"/>

A closed logical formulation of the statement (not shown) has xmi:id="pos-formulation".

Reference Scheme: An [id of the example term and the set of authors of the example term](#)
<sbvr:referenceScheme xmi:id="refScheme" simplyUsedRole="ethi-r2" extensionallyUsedRole="etha-r2" identifyingCharacteristic=""/>

It is assumed for this entry that there is a binary verb concept ‘[example term has id](#)’ whose ‘[id](#)’ role has xmi:id="ethi-r2".

It is assumed for this entry that there is a binary verb concept ‘[example term has author](#)’ whose ‘[author](#)’ role has xmi:id="etha-r2".

See: [example general concept designation](#)

Same as “Synonym: [example general concept designation](#)”.

Source: ISO 1087-1 [‘example’]
<sbvr:referenceSupportsMeaning reference="ref" meaning="meaning"/>
<sbvr:reference xmi:id="ref" expression="source-e"/>
<sbvr:text xmi:id="source-e" value="ISO 1087-1 [‘**example**’]"/>

Subject Field:

[Philosophy](#)

```
<sbvr:representationInSubjectField representation="exampleTerm" subjectField="philosophy"/>
<sbvr:conceptHasInstance concept="philosophy" instance="philosophy"/>
<sbvr:subjectField xmi:id="philosophy"/>
```

It is assumed for this entry that there is a name '[Philosophy](#)' for an individual noun concept like this:

```
<sbvr:name xmi:id="philo-name" signifier="philo-s" meaning="philosophy"/>
<sbvr:individualConcept xmi:id="philo-concept"/>
<sbvr:text xmi:id="philo-s" value="Philosophy"/>
```

Synonym:

[example general concept designation](#)

```
<sbvr:term xmi:id="exampleObjectTypeDesignation" signifier="eotd-s" meaning="meaning"/>
<sbvr:text xmi:id="eotd-s" value="example general concept designation"/>
<sbvr:thingsInSet set="vocabulary" thing="exampleObjectTypeDesignation"/>
<sbvr:designationInNamespace designation="exampleObjectTypeDesignation" namespace="vocabularyNamespace"/>
```

23.7.3 XML Patterns for Individual Noun Concepts

[Example Name](#)

```
<sbvr:name xmi:id="exampleName" signifier="en-s" meaning="meaning"/>
<sbvr:individualConcept xmi:id="meaning"/>
<sbvr:text xmi:id="en-s" value="Example Name"/>
<sbvr:thingsInSet set="vocabulary" thing="exampleName"/>
<sbvr:designationInNamespace designation="exampleName" namespace="vocabularyNamespace"/>
```

If there is no “See:” caption, then the following is included:

```
<sbvr:preferredDesignation xmi:id="exampleNamePreferred"/>
<sbvr:thing1IsThing2 thing1="exampleNamePreferred" thing2="exampleName"/>
```

Definition:

[the example that is seen](#)

```
<sbvr:definiteDescription xmi:id="defDesc-formal" expression="defDesc-formal-e" meaning="meaning"/>
<sbvr:text xmi:id="defDesc-formal-e" value="the example that is seen"/>
<sbvr:concept1SpecializesConcept2 concept1="meaning" concept2="example-concept" />
<sbvr:closedProjectionFormalizesDefinition closedProjection="defDesc-formal-projection" definition="defDesc-formal"/>
<sbvr:closedProjectionDefinesNounConcept closedProjection="defDesc-formal-projection" nounConcept="meaning"/>
```

The closed projection of the definition (not shown) has xmi:id="defDesc-formal-projection". Note that informal and semiformal definitions of individual noun concepts follow the same pattern as shown for general concepts above with the exception that they are rendered as sbvr:definiteDescription.

The captions “Concept Type:”, “Description:”, “Dictionary Basis:”, “Example:”, “General Concept:”, “Necessity:”, “Note:”, “Possibility:”, “See:”, “Source:”, “Subject Field:” and “Synonym:” are handled for a name in the same way as for terms as shown above.

23.7.4 XML Patterns for Verb Concepts

[example is seen](#)

```
<sbvr:sententialForm xmi:id="exampleIsSeen" expression="eis-e" meaning="meaning" placeholder="eis-p"/>
<sbvr:verbSymbol xmi:id="example.isSeen" signifier="isSeen-s" meaning="meaning"/>
<sbvr:characteristic xmi:id="meaning" role="eis-r"/>
```

```

<sbvr:verbConceptWordingIncorporatesVerbSymbol verbConceptWording="exampleIsSeen" verbSymbol="example.isSeen"/>
<sbvr:text xmi:id="eis-e" value="example is seen"/>
<sbvr:text xmi:id="isSeen-s" value="is seen"/>
<sbvr:placeholder xmi:id="eis-p" expression="example-s" startingCharacterPosition="i1" meaning="eis-r"/>
<sbvr:placeholderUsesDesignation placeholder="eis-p" designation="example"/>
<sbvr:positiveInteger xmi:id="i1" value="1"/>
<sbvr:verbConceptRole xmi:id="eis-r"/>
<sbvr:roleRangesOverObjectType role="eis-r" generalConcept="example-concept"/>
<sbvr:thingsInSet set="vocabulary" thing="exampleIsSeen"/>
<sbvr:thingsInSet set="vocabulary" thing="example.isSeen"/>
<sbvr:verbConceptWordingInNamespace verbConceptWording="exampleIsSeen" namespace="vocabularyNamespace"/>
<sbvr:attributiveNamespacesWithinVocabularyNamespace attributiveNamespace="example-ans"
  vocabularyNamespace="vocabularyNamespace"/>
<sbvr:attributiveNamespace xmi:id="example-ans"/>
<sbvr:attributiveNamespacesForSubjectConcept attributiveNamespace="example-ans"
  subjectConcept="example-concept"/>
<sbvr:designationInNamespace designation="example.isSeen" namespace="example-ans"/>

```

example₁ follows example₂

```

<sbvr:sententialForm xmi:id="example1FollowsExample2" expression="efe-e" meaning="meaning" placeholder="efe-p1 efe-p2"/>
<sbvr:verbSymbol xmi:id="efe-follows" signifier="follows-s" meaning="meaning"/>
<sbvr:binaryVerbConcept xmi:id="meaning" role="efe-r1 efe-r2"/>
<sbvr:verbConceptWordingIncorporatesVerbSymbol verbConceptWording="example1FollowsExample2" verbSymbol="efe-follows"/>
<sbvr:text xmi:id="efe-e" value="example1 follows example2"/>
<sbvr:text xmi:id="follows-s" value="follows"/>
<sbvr:text xmi:id="example1-s" value="example1"/>
<sbvr:text xmi:id="example2-s" value="example2"/>
<sbvr:placeholder xmi:id="efe-p1" expression="example1-s" startingCharacterPosition="i1" meaning="efe-r1"/>
<sbvr:placeholder xmi:id="efe-p2" expression="example2-s" startingCharacterPosition="i18" meaning="efe-r2"/>
<sbvr:placeholderUsesDesignation placeholder="efe-p1" designation="example"/>
<sbvr:placeholderUsesDesignation placeholder="efe-p2" designation="example"/>
<sbvr:positiveInteger xmi:id="i1" value="1"/>
<sbvr:positiveInteger xmi:id="i18" value="18"/>
<sbvr:verbConceptRole xmi:id="efe-r1"/>
<sbvr:verbConceptRole xmi:id="efe-r2"/>
<sbvr:roleRangesOverObjectType role="efe-r1" generalConcept="example-concept"/>
<sbvr:roleRangesOverObjectType role="efe-r2" generalConcept="example-concept"/>
<sbvr:thingsInSet set="vocabulary" thing="example1FollowsExample2"/>
<sbvr:thingsInSet set="vocabulary" thing="efe-follows"/>
<sbvr:verbConceptWordingInNamespace verbConceptWording="example1FollowsExample2"
  namespace="vocabularyNamespace"/>

```

Definition: [the example₁ comes after the example₂ in a sequence](#)

```

<sbvr:definition xmi:id="efe-def-formal" expression="efe-def-formal-e" meaning="meaning"/>
<sbvr:text xmi:id="efe-def-formal-e" value="the example1 comes after the example2 in a sequence"/>
<sbvr:closedProjectionFormalizesDefinition closedProjection="efe-projection" definition="efe-def-formal"/>
<sbvr:closedProjectionDefinesverbConcept closedProjection="efe-projection" verbConcept="meaning"/>
<sbvr:variableMapsToVerbConceptRole variable="efe-var1" verbConceptRole="efe-r1"/>
<sbvr:variableMapsToVerbConceptRole variable="efe-var2" verbConceptRole="efe-r2"/>

```

The definition formally defines ‘[example₁ follows example₂](#)’ and has a closed projection (not shown) with xmi:id="efe-projection" projectionVariable="efe-var1 efe-var2".

Definition: the first example is after the second
 <sbvr:definition xmi:id="efe-def-informal" expression="efe-def-informal-e" meaning="meaning"/>
 <sbvr:text xmi:id="efe-def-informal-e" value="the first example is after the second"/>

See: [example₁](#) *has* [prior example](#)

Same as “Synonymous Form: [example₁](#) *has* [prior example](#)”.

Synonymous Form: [example₁](#) *has* [prior example](#)

```
<sbvr:sententialForm xmi:id="example1HasPriorExample" expression="ehpe-e" meaning="meaning" placeholder="ehpe-p1
ehpe-p2"/>
<sbvr:verbSymbol xmi:id="ehpe-has" signifier="has-s" meaning="meaning"/>
<sbvr:verbConceptWordingIncorporatesVerbSymbol verbConceptWording="example1HasPriorExample" verbSymbol="ehpe-has"/>
<sbvr:verbConceptRoleDesignation xmi:id="example.priorExample" signifier="priorExample-s" meaning="efe-r2"/>
<sbvr:text xmi:id="ehpe-e" value="example1 has prior example"/>
<sbvr:text xmi:id="has-s" value="has"/>
<sbvr:text xmi:id="priorExample-s" value="prior example"/>
<sbvr:placeholder xmi:id="ehpe-p1" expression="example1-s" startingCharacterPosition="i1" meaning="efe-r1"/>
<sbvr:placeholder xmi:id="ehpe-p2" expression="priorExample-s" startingCharacterPosition="i14" meaning="efe-r2"/>
<sbvr:placeholderUsesDesignation placeholder="ehpe-p1" designation="example"/>
<sbvr:positiveInteger xmi:id="i1" value="1"/>
<sbvr:positiveInteger xmi:id="i14" value="14"/>
<sbvr:thingsInSet set="vocabulary" thing="example1HasPriorExample"/>
<sbvr:verbConceptWordingInNamespace verbConceptWording="example1HasPriorExample" namespace="vocabularyNamespace"/>
>
<sbvr:attributiveNamespacelsWithinVocabularyNamespace attributiveNamespace="example-ans"
vocabularyNamespace="vocabularyNamespace"/>
<sbvr:attributiveNamespace xmi:id="example-ans"/>
<sbvr:attributiveNamespacelsForSubjectConcept attributiveNamespace="example-ans"
subjectConcept="example-concept"/>
<sbvr:designationInNamespace designation="example.priorExample" namespace="example-ans"/>
```

If there is a term ‘[prior example](#)’ for a general concept like this:

```
<sbvr:term xmi:id="priorExample" signifier="priorExample-s" meaning="priorExample-c"/>
```

then the following is included:

```
<sbvr:placeholderUsesDesignation placeholder="ehpe-p2" designation="priorExample"/>
<sbvr:roleRangesOverObjectType role="efe-r2" generalConcept="priorExample-c"/>
```

The captions “Concept Type:”, “Description:”, “Dictionary Basis:”, “Example:”, “General Concept:”, “Necessity:”, “Note:”, “Possibility:” and “Source:” are handled for a verb concept wording in the same way as for terms as shown above.

23.7.5 XML Patterns for Sets of Elements of Guidance (Rule Sets)

XYZ Rules

```
<sbvr:set xmi:id="ruleSet"/>
<sbvr:nameReferencesThing thing="ruleSet" name="XYZRules"/>
<sbvr:name xmi:id="XYZRules" signifier="XYZRules-s" meaning="ruleSet-concept"/>
```

```

<sbvr:individualConcept xmi:id="ruleSet-concept" instance="ruleSet"/>
<sbvr:text xmi:id="XyzRules-s" value="Xyz Rules"/>
<sbvr:thingsInSet set="vocabulary" thing="XyzRules"/>
<sbvr:designationInNamespace designation=" XyzRules " namespace="vocabularyNamespace"/>

```

Vocabulary: [Abc Vocabulary](#)

None.

The captions “Description:”, “Note:”, and “Source:” are handled for a rule set in the same way as for terms within a vocabulary, as shown above, except that the related meaning is given as meaning="ruleSet-concept".

23.7.6 XML Patterns for Guidance Statements

Each **example must be seen**.

```

<sbvr:guidanceStatement xmi:id="stmt-formal" expression="stmt-formal-e" meaning="meaning"/>
<sbvr:elementOfGuidance xmi:id="meaning"/>
<sbvr:text xmi:id="stmt-formal-e" value="Each example must be seen" ./>
<sbvr:closedLogicalFormulationFormalizesStatement closedLogicalFormulation="stmt-formal-formulation"
statement="stmt-formal"/>
<sbvr:closedLogicalFormulationMeansProposition closedLogicalFormulation="stmt-formal-formulation" proposition="meaning"/>
<sbvr:thingsInSet set="ruleSet" thing="meaning"/>

```

The closed logical formulation of the statement (not shown) has xmi:id="stmt-formal-formulation".

Guidance Type: [behavioral business rule](#)

In this case where the guidance type is an SBVR concept, the line above that says, “<sbvr:elementOfGuidance xmi:id="meaning"/>”, is replaced with this:

```

<sbvr:behavioralBusinessRule xmi:id="meaning"/>

```

Guidance Type: [exemplary rule](#)

```

<sbvr:conceptHasInstance concept="exemplaryRule-c" instance="meaning"/>

```

This pattern is used if the concept type is not an SBVR concept. There is assumed to be a term ‘[exemplary rule](#)’ for a general concept like this:

```

<sbvr:term xmi:id="exemplaryRule" signifier="exemplaryRule-s" meaning="exemplaryRule-c"/>
<sbvr:generalConcept xmi:id="exemplaryRule-c"/>
<sbvr:text xmi:id="exemplaryRule-s" value="exemplary rule"/>

```

Enforcement Level: [strict](#)

```

<sbvr:behavioralBusinessRuleHasLevelOfEnforcement
behavioralBusinessRule="meaning"
levelOfEnforcement="strict-instance"/>
<sbvr:conceptHasInstance concept="strict-concept" instance="strict-instance"/>
<sbvr:levelOfEnforcement xmi:id="strict-instance"/>

```

It is assumed that the name ‘[strict](#)’ represents an individual noun concept like this:

```

<sbvr:name xmi:id="strict" signifier="strict-s" meaning="strict-concept"/>
<sbvr:individualConcept xmi:id="strict-concept"/>
<sbvr:text xmi:id="strict-s" value="strict"/>

```

Name:

Rule 25

```
<sbvr:nameReferencesThing thing="meaning" name="Rule25"/>
<sbvr:name xmi:id="Rule25" signifier="Rule25-s" meaning="rule25Meaning"/>
<sbvr:individualConcept xmi:id="rule25Meaning" instance="meaning"/>
<sbvr:text xmi:id="Rule25-s" value="Rule 25"/>
<sbvr:thingsInSet set="vocabulary" thing="Rule25"/>
<sbvr:designationInNamespace designation="Rule25" namespace="vocabularyNamespace"/>
```

Synonymous Statement: **It is obligatory that each rule be seen.**

```
<sbvr:guidanceStatement xmi:id="synstmt-formal" expression="synstmt-formal-e" meaning="meaning"/>
<sbvr:text xmi:id="synstmt-formal-e" value="It is obligatory that each rule be seen" ./>
<sbvr:closedLogicalFormulationFormalizesStatement closedLogicalFormulation="synstmt-formal-formulation"
statement="synstmt-formal"/>
<sbvr:closedLogicalFormulationMeansProposition closedLogicalFormulation="synstmt-formal-formulation" proposition="meaning"/>
```

The closed logical formulation of the statement (not shown) has xmi:id="synstmt-formal-formulation".

The captions “Description:”, “Example:”, “Note:” and “Source:” are handled for a guidance statement in the same way as for terms as shown above.

24 Providing Semantic and Logical Foundations for Business Vocabulary and Rules

24.1 General

This clause lists and explains foundational concepts taken from respected works on formal logics and mathematics. A mapping is then shown from the concepts in the SBVR Vocabularies in Clauses 7 through 21 to these foundational concepts.

Sub clause 10.1 provides a formal semantics for the concepts in the SBVR Vocabularies in Clauses 7 through 21. Clause 24.3 provides the mapping of the concepts in the SBVR Vocabularies in Clauses 7 through 21 to ISO Common Logic and to OWL/ODM.

24.2 Logical Foundations for SBVR

24.2.1 SBVR Formal Grounding Model Interpretation

24.2.1.1 Introduction

A conceptual model includes both a conceptual schema and a population of facts that conform to the schema. A conceptual model may cover any desired time span, and contain facts concerning the past, present, or future. This notion is distinct from changes made to a conceptual model. Any change to a conceptual model, including any change to any fact in the fact population, creates a different conceptual model. Each conceptual model is distinct and independent, although there may be relationships between conceptual models that share the same conceptual schema.

‘Facts’ are one of the primary building blocks of the formal interpretation of SBVR presented here. A ‘Ground Fact’ is of a particular ‘Fact Type.’ The lowest level logical unit in SBVR – an ‘Atomic Formulation’ – is a logical formulation based directly upon a verb concept, involving no logical operation. An atomic formulation may be considered as an invocation of a predicate.

The formal interpretation of SBVR presented here makes no distinction about how facts are known: for example, whether they are asserted as ‘ground facts’ or obtained by inference. Inferences can be performed within a particular fact model. The formal interpretation of SBVR presented here does not define any kind of inference that can be made between fact models.

Control over the order in which inferences can be made is a common feature in the automation of inference, as found, for example, in rules engines. SBVR deals with declarative rules expressed from a business perspective. Transitions between fact models and the mechanization of those rules in an automated system are outside the scope of SBVR.

Closed-world assumptions are often used in automated systems, such as the well-known ‘negation by failure’ in the Prolog language. The business orientation of SBVR makes it natural to assume open-world semantics by default. For example, if we assume that ‘Customers’ have some unary fact such as ‘Credit OK’ then we cannot assume anything like ‘Credit not OK’ in the absence of this fact. The formal interpretation of SBVR presented here permits fact types to be explicitly identified as closed where this makes business sense. For example, it may be appropriate to infer ‘Credit not OK’ for a subset of customers identified as ‘Credit-Checked Customers’ in the absence of a ‘Credit OK’ fact.

The detailed definition of SBVR uses the vocabulary defined in SBVR – in other words, SBVR is defined in terms of itself. This inevitably makes the SBVR vocabularies higher order, but this does not force any modeler to produce exclusively higher-order models. The formal interpretation of SBVR presented here can be used to produce first order interpretations for SBVR vocabularies if that is what is desired by the modeler.

The SBVR (Semantics of Business Vocabulary and Business Rules) vocabularies are used to describe business vocabularies and business rules that may be expressed either informally or formally. Business rule expressions are classified as formal only if they are expressed purely in terms of noun concepts and verb concepts, as well as certain logical/ mathematical operators, quantifiers, etc. The following discussion of business rule semantics is confined to formal statements of business rules. (A closer definition of terms is given as needed later throughout this clause.)

The rest of this clause is structured as follows: sub clause 24.2.1.2 provides some basic background and terminology, explaining our usage of terms such as “schema,” “model,” and “fact.” 24.2.1.3 reviews the approach to choosing open or closed world semantics. 24.2.1.4 provides an overview of the use of quantifiers as well as alethic or deontic modal operators in specifying business rules. 24.2.1.5 and 24.2.1.6 respectively discuss the formal semantics for static, alethic constraints and static, deontic constraints. 24.2.1.7 considers derivation rules. 24.2.1.8 examines dynamic constraints. 24.2.1.9 reviews the option for using higher-order logic.

24.2.1.2 Facts, Schemas, and Models

For any given business, the “universe of discourse” indicates those aspects of the business that are of interest. The term “business domain” is commonly used in the modeling community, with equivalent meaning. A “model,” in the sense used here, is a structure intended to describe a business domain, and is composed of a conceptual *schema* (fact structure) and a *population* of ground facts (see later). A *fact* is a proposition taken to be true by the business. Population facts are restricted to elementary and existential facts (see later).

Instantiated roles of facts refer to individuals (such as “Employee 123” or “the sales department”). These individuals are considered as being of a particular type (such as “Employee” or “Department”) where *type* denotes “set of possible individuals.”

SBVR’s ‘general concept’, ‘individual noun concept’ and ‘verb concept’ are three kinds of concept (unit of knowledge created by a unique combination of characteristics [per ISO-1087-1]). Each is a kind of meaning – respectively, the meaning of an improper noun phrase, the meaning of a proper noun and the meaning of a verb phrase in the context of a declarative sentence. Instances of verb concepts are actualities that involve things that exist in the universe of discourse. These instances are not propositions. In contrast, the logical underpinnings of these three kinds of concepts are ‘type of individual’, singleton ‘type of individual’, and ‘fact type’, respectively.

- General concepts logically map to types of individual. Each type of individual is a set of possible instances of the general concept according to a set of possible existential facts that can be formulated based on reference schemes.
- Individual noun concepts logically map to singleton types of individuals. Each single type of individual has exactly one element, which is the instance of the individual noun concept.

Verb concepts map to fact types, each fact type being a set of possible ground facts that can be formulated based on the verb concept and that use reference schemes to identify, for each fact, each thing that fills each role.

The conceptual schema declares the *concepts*, *fact types* (kinds of facts, such as “Employee works for Department”) and *rules* relevant to the business domain.

The terms ‘rule’ and ‘business rule,’ in the senses used here, are defined in 24.2.2. Rules are effectively higher-level facts (i.e., facts about propositions), and in a loose sense are also sometimes considered under the generic term ‘fact.’ For clarity, the term “ground fact” is used here to explicitly exclude such (meta) facts.

Constraints are used to define bounds, borders, or limits on fact populations, and may be static or dynamic. A *static constraint* imposes a restriction on what fact populations are possible or permitted, for each fact population taken individually.

Static constraint

Each Employee was born on **at most one** Date

A *dynamic constraint* imposes a restriction on transitions between fact populations.

Dynamic constraint

A person's marital status may change from single to married, but not from divorced to single

Derivation rules indicate how the population of a fact type may be derived from the populations of one or more fact types or how a type of individual may be defined in terms of other types of individuals and fact types.

Derivation rules

Person₁ is an uncle of Person₂ **if** Person₁ is a brother of **some** Person₃ **who** is a parent of Person₂,

Each Australian **is a** Person **who** is a citizen of Country 'AU.'

A model of the kind considered here is a *fact model*, not a process model. The term *knowledge base* is sometimes used to reflect this focus (on what is known, as opposed to what must be done). At least two kinds of fact model may be specified: reality models; and in-practice models. Although both these models use the same set of fact types, they may differ in the constraints imposed on those fact types. A *reality model* of a business domain is intended to reflect the constraints that actually apply to the business domain in the real world. An *in-practice model* of a business domain reflects the constraints that the business chooses in practice to impose on its knowledge of the business domain.

Suppose the following two fact types are of interest: Employee was born on Date; Employee has PhoneNumber. In the real world, each employee is born, and may have more than one phone number. Hence the reality model includes the constraint "**Each** Employee was born on **at least one** Date" and allows that "**It is possible that the same** Employee has **more than one** PhoneNumber." Now suppose that the business decides to make it optional whether it knows an employee's birth date. Suppose also that the business is interested in knowing at most one phone number for any given employee. In this case, the in-practice model excludes the reality constraint "**Each** Employee was born on **at least one** Date," but it includes the following constraint that doesn't apply in the reality model: **Each** Employee has **at most one** PhoneNumber.

Constraint differences between reality and in-practice models have some restrictions (for instance, in-practice uniqueness constraints need to be at least as strong as the corresponding real world uniqueness constraints, and if a fact type role is optional in the real world it is optional in the in-practice world, but the converse need not apply).

Reality schemas are sometimes constructed first to help determine in-practice schemas. Although a population may be added to any schema to form a model, it is common to add populations only to in-practice schemas. So in-practice models are more common than reality models. The possibility of incomplete knowledge arises for both reality and in-practice models but is

more prevalent with in-practice models since these tend to include more optional aspects. Adoption of open or closed world assumptions is discussed in 24.2.1.3.

Example of incomplete knowledge

The business might know just some of a given employee's phone numbers

We use the term “fact model” or “knowledge base” in a broad sense. Conceptually, the fact model is represented by a set of sentences, each of which connotes either a rule or a ground fact. The fact model may be fully automated (as in, say, a database system), manual (as in, say, a paper record system), or semi-automated. The knowledge may even be stored in human memory (belonging to the business domain experts who may be collectively regarded as the authoritative source of those business facts that are of interest). However, the knowledge must ultimately be expressible by sentences communicated between humans.

A fact model is a conceptual model of the business domain, using a suitable high level vocabulary and language that is readily understood by the business domain experts. Typically this language will be a formal subset of a natural language. In particular, the language is not a machine-oriented technical language (such as C# or Java) that might be used to implement a system to enforce at least some of the business rules included in the model. Business domain models are meant to capture the relevant business rules, not to implement them. Whether a given business rule is implemented at all, or how it might be implemented (automated, semi-automated, or manual) are not issues here. Typically however, it is expected that many business rules specified in a business domain model will likely be enforced in an automated way; and in such cases, the rules need to be formally expressed.

Any fact model passes through a sequence of *states*, each of which includes a set of *ground facts*, which are either elementary or existential. Roughly speaking, an *elementary fact* is a declaration that an individual has a property, or that one or more individuals participate in a relationship, where the fact cannot be split into simpler facts with the same individuals (without information loss).

Examples of elementary facts

The Country named ‘Australia’ is large

The President named ‘Bill Clinton’ was born in the State named ‘Arkansas’

An elementary fact may be treated as an instantiation of a typed, irreducible predicate of interest to the business, except that multiple fact type readings using different predicates, possibly based on different orderings of the individuals, are considered to express the same fact if they mean the same. Individuals are typically denoted by definite descriptions.

The sentences (1) and (2) below express the same fact:

(1) The President named ‘Bill Clinton’ was born in the State that has the State Name ‘Arkansas.’

(2) The State that has the State Name ‘Arkansas’ is the birthplace of the President named ‘Bill Clinton.’

“The President named ‘Bill Clinton’” is treated here as shorthand for “The President who has the President Name ‘Bill Clinton’” .

Instead of definite descriptions, proper names may be used if they function as individual constants in the business domain. Lexical individuals denote themselves. Individual constants may also be introduced as abbreviations of definite descriptions.

Example of a self-denoting lexical individual

The country code ‘US’

We use the term “fact” in the sense of “proposition taken to be true by the business” (i.e., the business members are prepared to act as if they believed the proposition is true; their attitude toward the proposition is one of epistemic commitment). This sense of epistemic commitment does not require any special interpretation of logical operators, or use of epistemic or doxastic logic. The logical connectives (and, or, not, if-then, etc.) may be interpreted just like truth functional operators (conjunction, disjunction, negation, material implication, etc.) in 2-valued classical logic. An *existential fact* is used to simply assert the existence of an individual,

Example of an existential fact

There is a Country that has the Country Code 'US'

A *fact type* may be identified by one or more fact type readings that declare typed predicates.

Examples of fact type readings

The President named 'Mary McAleese' governs the Country that has the Country Name 'Ireland'

is an instance of the fact type

President governs Country

The Country that has the Country Name 'Ireland' is governed by the President named 'Mary McAleese'

is an instance of the fact type

Country is governed by President

Sub clause 24.2.1 uses initial capitals to denote types of individuals (other styles may be used for this purpose), and in general allows predicates in mixfix notation.

Example of mixfix notation

President visited Country on Date

More conventional but less readable syntaxes may also be used.

Example of more conventional notation

President governs Country

may be expressed as

`governs(x:President; y:Country)`

Each predicate has a fixed arity, so variadic predicates are not supported.

For example, the unary "smokes" predicate in 'Person smokes' is considered to be different from the binary "smokes" predicate in 'Person smokes Cigar Brand.'

Note that we do not identify untyped predicates simply by their name and arity.

For example, the "has" in 'Person has Disease' is considered to be a different predicate from the "has" in 'Disease has Cure.'

The fact model includes both the conceptual schema and the ground fact population (set of fact instances that instantiate the fact types in the schema). The conceptual schema includes a generic component and a domain-specific component. The generic component is common to all conceptual schemas: this includes relevant axioms from logic and mathematics¹. The domain-specific component includes the concept definitions and declarations of the ground fact types and business rules relevant to the specific business domain.

Trivially, each fact model includes existential facts to declare the existence of generic constants such as numbers, but we ignore these in our discussion, confining the use of "population" to the domain-specific population of interest. With that understanding, the fact model at any point in time may be declared as a set of sentences that collectively express the conceptual schema and the fact population of the domain-specific fact types in the conceptual schema.

Although in practice the conceptual schema may evolve over time (if the business domain changes its structure or scope of interest) we ignore schema evolution here, treating the conceptual schema as fixed. Schema evolution may be handled as a metametalevel concern. Model exchange must be enabled between a system supporting SBVR and other systems identified as desirable targets for interoperability. Any exchange of a fact model takes place at a given point in time, and at that time the conceptual schema is fixed (later exchanges may be used to update the fact model as required). Also, when a necessity is originally stated, the intent is that by default the rule should stay in force.

In contrast to the conceptual schema, the (domain-specific) fact population is typically highly variable.

For example, the fact type "Employee works on Project" may initially have no instances, but over time thousands of employees may be added or removed from various project teams.

Figure 24.1 provides a simplified picture of this situation, indicating that the fact model of sentences expressing population facts (instances of domain-specific fact types) is a varset (variable-set) whose population at any given time is a set of facts.

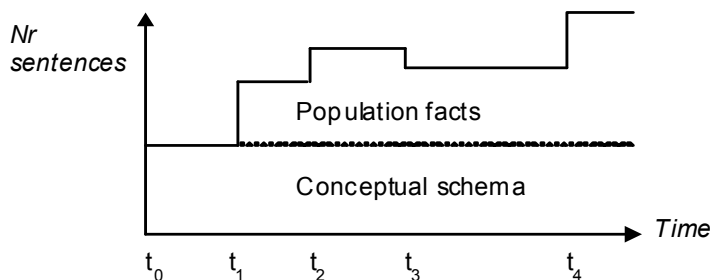

Figure 24.1 - Evolution of the fact model (schema plus ground fact instances)

1. For a detailed discussion of one way to formalize this, see [Halp1989]. A fact model is specified as a set of sentences in a language based on predicate logic with identity. An interpretation is defined in the usual way (e.g., each predicate symbol maps onto a relation over the domain of individuals) and a model (not the same as fact model) is an interpretation where all the sentences are true.

The fact model may be initially empty or pre-populated with some facts. The fact model may expand or shrink over time as facts are added or removed from it. At any point in time, the fact model includes a set of facts. Figure 24.2 depicts this situation in more detail, using a labeled box to denote a fact instance (f1 = fact 1, etc.).

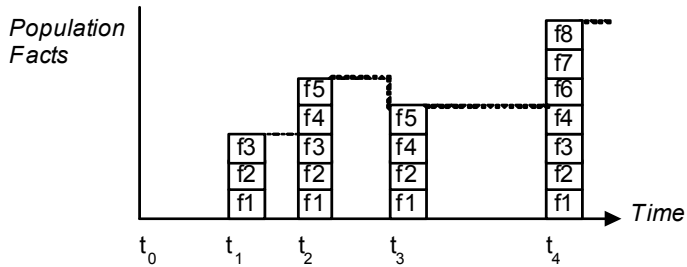

Figure 24.2- Evolution of the ground fact population

In treating a fact model as a varset of facts that typically changes over time, we allow facts to be added or deleted (see Figure 24.2). We might delete a fact because we revise our decision on whether it is (taken to be) true (for instance, we might discover a mistake), or because we decide that fact is no longer of interest. Now consider the following description by [Anto2001] of non-monotonic logic.

The term “non-monotonic logic” covers a family of formal frameworks devised to capture and represent *defeasible inference*, i.e., that kind of inference of everyday life in which reasoners draw conclusions tentatively, reserving the right to retract them in the light of further information. Such inferences are called “non-monotonic” because the set of conclusions warranted on the basis of a given knowledge base does not increase (in fact, it can shrink) with the size of the knowledge base itself. This is in contrast to classical (first-order) logic, whose inferences, being deductively valid, can never be “undone” by new information.

On the surface, it would appear that we are committing to a non-monotonic logic, given that we allow facts to be deleted in going from one state to another. However it seems reasonable to formalize those business rules that are static constraints in terms of classical, non-monotonic logic.

For example, we might formalize the static constraint that each person was born on some date as an SBVR logical formulation of the formula $\forall x:\text{Person} \exists y:\text{Date} x \text{ was born on } y$.

In classifying the rule as a static constraint, we assert that it is true for each state of the fact model, taken individually. This seems to be enough, from the point of view of exchanging fact models, which always involves just one state at that time. Note also that the characterization of fact models as variable sets of sentences does not claim that propositions change their truth value over time. We regard propositions to be atemporal: they are timelessly true or false, so never change their truth value.

At least superficially, it is possible that a sentence in one fact model state expresses a different proposition from that expressed by the same sentence in another fact model state. For example, the meaning of time-deictic sentence occurrences depends on the time they were uttered or inscribed.

For instance, given the static constraint that each person lives in at most one country, we might assert for the fact model state 1 that Terry lives in Australia, for fact model state 2 we delete “Terry lives in Australia” and add that Terry lives in Utah, and for fact model state 3 we delete “Terry lives in Utah” and add that Terry lives in Australia. This does not involve any change in proposition truth values, because different propositions were being asserted in the different states. Here the verb phrase “lives in” means “currently lives in,” where ‘currently’ may be unpacked into a time-indexed expression that includes the time of that fact model state.

24.2.1.3 Open/Closed World Semantics

Adopting *closed world* semantics basically means that all relevant facts are known (either as primitives – not defined in terms of other things – or derivable). So if a proposition cannot be proved true, it is assumed to be false. This *closed world assumption* entails *negation by failure*, since failure to find a fact implies its negation. *Open world semantics* allows that some knowledge may be incomplete; so if a proposition and its negation are both absent, it is unknown whether the proposition is true.

In modeling any given business domain, attention can be restricted to propositions *of interest* to that domain. If a proposition is not relevant to that domain, it is not included as a fact there, but we do not assume it is false; rather we simply dismiss it from consideration. For any business domain, we have a *finite set of types of individuals and fact types* (typed predicates), and any type of individual or fact type outside this set is simply disregarded.

It is a practical issue whether one’s knowledge pertaining to the population of a given fact type is complete or not, since this may impact how the business derives other facts (e.g., negations) or how it reacts to query results (e.g., whether to treat “not” as “not the case” or merely “not known to be the case”). So we regard the issue of open/closed world semantics to be relevant to the fact model itself, not just automated implementations of the fact model.

Many implementations treat “not” in the closed-world sense of either “not known” (as a primitive or derivable fact), i.e., negation as failure, or “not known as a primitive fact,” i.e., semi-positive negation. For instance, Prolog-based rule engines rely on negation by failure, and the “not” in SQL means “not recorded in a base table or derivable in a view.”

SQL example,

Figure 24-3 depicts the relational schema and a sample population for a database fragment used to store the employee number and name of each employee, as well as the cars they drive (if any).

employee (empNr, empName)	Employee			Drives	
	<i>empNr</i>	<i>empName</i>		<i>empNr</i>	<i>carRegNr</i>
Drives (empNr, carRegNr)	1 2 3	John Smith Ann Jones John Smith		1 2 3	ABC123 AAA246 DEF001

Figure 24.3 - A sample database storing some facts about employees

Suppose we want to know the employee number and name of each employee. In SQL we might formulate this query as **select * from Employee**, which returns the three rows of data shown in the Employee table. This result returns the employee number and name of those employees referenced in the database. Whether this includes all the employees in the business domain depends on whether the database is complete with respect to the population of the elementary fact type Employee has EmployeeName. If it is complete, the fact type is closed, and we may treat the SQL query as equivalent to our intended query about the business domain. If it is not complete, then the fact type is open, and we may need to take into account that there may be more employees than listed in the result.

Knowledge about completeness is typically not stored in databases, although in principle it could be. Users typically adopt the closed world assumption when interpreting data in relational databases. If independently of the database system they know how complete the data is, they may take that into account in deciding how completely the query results from the database system relate to the real world of their business domain.

Suppose we want to know the employee number of each employee who does not drive a car for the database shown in Figure 24-3. In SQL we might formulate this query as **select empNr from Employee where empNr not in (select empNr from Drives)**. This returns just one employee number (viz. 3). Whether this covers all the non-driver employees in the business domain depends on whether the population of the two fact types (Employee has EmployeeName and Employee drives Car) is complete or not. Again, this knowledge about completeness could be stored in the database, but typically isn't, in which case users need to rely on their own knowledge about completeness to decide whether the data returned is complete or not.

The approach adopted here is fact-based (as opposed to attribute-based), where each fact type is modeled as a type of relationship, never as an attribute. Annex J provides extended examples of fact types expressed in this way using a popular fact-based modeling approach.

Example fact-based representation of a database schema

The information structure implied by the database schema shown in Figure 24-3 can be expressed as a set of fact types and constraints as follows, using the capitalized mixfix notational style described earlier:

Types of individuals

Employee

Car

Employee Number

Employee Name

Car Registration Number

(Note that here Employee and Car represent the kind of real world individuals that typically change state. Employee Number, Employee Name and Car Registration Number represent simple self-identifying lexical constants.)

Fact types

Employee has Employee Number

Employee has Employee Name

Car has Car Registration Number

Employee drives Car

Constraints

Each Employee has exactly one Employee Number.

For each Employee Number, at most one Employee has that Employee Number.

Each Employee has exactly one Employee Name.

Each Car has exactly one Car Registration Number.

For each Car Registration Number, at most one Car has that Car Registration Number.

It is possible that the same Employee drives more than one Car and that more than one Employee drives the same Car.

Completeness claims about a schema can be clarified by referring to whether fact type roles are mandatory and whether instances of fact type roles are unique. A fact type role is mandatory if, for each state of the fact model, each instance in the population of the associated type of individual must play that fact type role. A fact type role (or combination of fact type roles) is unique if, for each state of the fact model, each individual that instantiates the fact type role (or each sequence of individuals that instantiates the fact type role sequence) does so once only.

In the schema given above:

each Employee has exactly one Employee Name (mandatory fact type role) but it is optional whether an Employee drives a car.

each Employee has exactly one Employee Name: the Employee fact type role is unique in this fact type but the Employee Name fact type role is not (an Employee has only one Employee Name, but the same Employee Name could refer to more than one Employee).

To consider completeness claims, we can express additional requirements in terms of the fact model populations of types of individuals and the sequences of fact type roles they play in the population of fact types. A schema, as described earlier, is useful for clarifying the conditions under which completeness claims may be made.

Referring again to the Employee-Car schema, for any state of the fact model, let $pop(I)$ denote the fact model population of the type of individual I in that state, and let $pop(F)$ denote the fact model population of the fact type role sequence for the fact type F in that state. If the fact model is complete with regard to capturing the real world business domain, then for each state of the fact model the following three additional conditions are satisfied:

- (1) $pop(\text{Employee})$ = set of employees in the (real world) business domain (at that time)
- (2) $pop(\text{Car})$ = set of cars in the business domain
- (3) $pop(\text{Employee drives Car})$ = set of (employee, car) pairs from $pop(\text{Employee}) \times pop(\text{Car})$ where that employee drives that car in the business domain.

Requirements (1) and (2) declare that the fact model population of the Employee and Car types of individuals always matches that of the business domain being modeled. We may regard this as asserting the closed world assumption for those types of individuals. Requirement (3) asserts that for those employees and cars that are included in the fact model, if they drive a car then this fact is known. In combination, requirements (1) – (3) entail the closed world assumption for the drives fact type (if an employee drives a car in the business domain, this is known in the fact model).

Given the schema, and requirement (1), the closed world assumption is implied for the employee name fact type. This follows because of the mandatory and uniqueness constraints on the first fact type role (employee is closed, so we have all the employees; having a name is mandatory, so we have at least one name for each employee; the uniqueness constraint means that each employee has at most one name; so for all employees we now have all their names). Note that open world semantics still applies to the employee name fact type; in the presence of (1) and the constraints, this is equivalent to closed world semantics for that fact type.

For any given schema, the business might have complete knowledge about some parts and incomplete knowledge about other parts. So in practice, a mixture of open and closed world assumptions may apply. We use the term “*local closure*” (or “relative closure”) for the application of the closed world assumption to just some parts of the overall schema. One might assume open world semantics by default, and then apply local closure to specific parts as desired; or alternatively, assume closed world semantics by default and then apply “local openness.” We adopt the former approach as it seems more realistic when modeling real business domains.

Closure (i.e., local closure) may be explicitly asserted for any type of individual, on a one-by-one basis, to declare that for each state the fact model population agrees with that of the population of that type of individual in the actual business domain. The relevant meta-fact type is: “type of individual is closed.” It may be reasonable to assume closure for types of individual by default, but it seems unrealistic to assume closure for predicates.

Closure may also be asserted for fact types. *Semi-closure* is with respect to the fact model population of the types of individual playing a fact type role in the predicate. If closure has also been declared for these types, then (full) closure also holds for the fact type (i.e., closure with respect to the domain population of the types of individuals). The relevant meta-fact types are: “fact type is semi-closed” and “fact type is closed.” The meta-fact type “concept is closed” applies to both types of individuals and fact types, since both are concepts.

As seen earlier, closure for a fact type is sometimes implied. A *functional fact type role* is the complete argument of a uniqueness constraint. For schemas whose functional fact type roles are also functional in the business domain, the following implications hold. If a predicate includes a mandatory, functional fact type role, then that predicate is semi-closed by implication (as in the employee name example earlier). This result may be generalized to the case of a mandatory fact type role that has a frequency constraint of exactly n (although some attribute-based approaches do not deal reliably with various n -ary cases). If a type of individual has a set of functional fact type roles that are disjunctively mandatory and mutually exclusive (in

other words, they are spanned by an exclusive-or constraint), then the predicates that include those fact type roles are semi-closed by implication. If the type of individual has also been declared complete in such cases, then (full) closure applies.

For many fact types in a business domain, especially those without functional fact type roles, it is impractical to include all the negative instances as primitive facts.

For example, for the fact type “Employee drives Car,” there might be many thousands of cars, so one would normally not explicitly include negated facts such as “Employee 1 does **not** drive Car ‘AAA246’.”

In some cases however, especially with functional fact type roles or when the population is small, it is practical to include negated facts as base facts.

Example

To provide a concrete example of the alternative, we can consider the characteristic 'Person smokes,' and three instances of Person: Fred, Sue, and Tom (for simplicity we will ignore reference schemes and assume that a person may be identified by their first name).

Assume that we know that Fred smokes. If we use open-world semantics, then it is unknown whether Sue or Tom smoke. If we apply closed world semantics, then the absence of facts that Sue or Tom smoke entails that they don't smoke.

If, for each Person, it is known whether that person smokes or not, then we could adopt one of two approaches to model our business domain.

(a) Use two characteristics, such as 'Person smokes' and 'Person is a nonsmoker,' with an exclusive-or constraint between the fact types. In other words, a Person must play one fact type role or the other, but cannot play both.

(b) Use a binary fact type such as 'Person has Smoker Status' where Smoker Status is indicated by some suitable code such as 'S' or 'NS' (for smoker or nonsmoker respectively), together with the constraint that a Person has exactly one Smoker Status.

In each of these cases, negated facts are explicitly treated as primitive facts and the predicates are given open world semantics. Semi-closure is implied because of the constraints.

Now consider a business domain where we know that Fred smokes, and that Sue doesn't smoke, but are unsure whether Tom smokes. In this case we have three alternative approaches that we could consider.

(a) Use two characteristics, such as 'Person smokes' and 'Person is a nonsmoker,' with an exclusion constraint between the fact types. In other words, a Person may play one fact type role or the other (but not both) or may play neither fact type role. For the given scenario, we would have the facts 'Fred smokes,' 'Sue is a nonsmoker' and no information for Tom.

(b) Use a binary fact type such as 'Person has Smoker Status' where Smoker Status is indicated by some suitable code such as 'S' or 'NS' (for smoker or nonsmoker respectively), together with the constraint that a Person has zero or one Smoker Status value. For the given scenario we would have the facts 'Fred has Smoker Status 'S,'" 'Sue has Smoker Status 'NS,'" and no information for Tom.

(c) Use a binary fact type such as 'Person has Smoker Status' where Smoker Status is indicated by some suitable code such as 'S,' 'NS,' or '?' (for smoker, nonsmoker, or unknown, respectively), together with the constraint that a Person has exactly one Smoker Status. In this case we treat the 'unknown' value ('?') like any other value using 2-valued logic, rather than adopt a generic null based on 3-valued logic, as in SQL. For the given scenario we would have the facts "Fred has Smoker Status 'S,'" "Sue has Smoker Status 'NS,'" and "Tom has Smoker Status '?'."

The above discussion indicates some ways of declaring and inferring various kinds of closure in the underlying fact model, based on a default, open world semantics. Here, all business rules that are parsed as formal are given a logical formulation based on the fact types in the underlying model. When people formulate queries on the model population, they may either adopt whatever closure guarantees are formally captured in the model, or instead informally rely on their own knowledge about closure to decide whether the data returned is complete or not. Such informal knowledge is outside the fact model, and does not impact the formal semantics of the logical formulation used in exchanging fact models.

In addition to specifying fact models at a conceptual level, languages may be defined for querying these models directly at a conceptual level. These may include features such as the ability to specify projections in the scope of negation, as well as projections in the scope of the "whether-or-not" operator which is used to perform conceptual left outer joins [Bløe1996, Bløe1997]. Further details are outside the scope of this sub clause.

24.2.1.4 Quantifiers and Modalities

Static constraints apply to each state of the fact model, taken individually. These may typically be expressed as logical formulations that are equivalent to formulae in 2-valued, first-order predicate calculus with identity. The 2-valued restriction applies because the fact types on which the rules are based are elementary (irreducible), so their instances never involve nulls. For convenience, we can use mixfix notation for predicates, and predefine some numeric quantifiers in addition to \forall and \exists . Table 24.1 summarizes the pre-defined quantifiers.

Table 24.1- Quantifiers

<i>Symbol</i>	<i>Example</i>	<i>Name</i>	<i>Meaning</i>
\forall	$\forall x$	Universal Quantifier	For each and every x , taken one at a time
\exists	$\exists x$	Existential Quantifier	At least one x
\exists^1	$\exists^1 x$	Exactly-one quantifier	There is exactly one (at least one and at most one) x
$\exists^{0..1}$	$\exists^{0..1} x$	At-most-one quantifier	There is at most one x

Table 24.1- Quantifiers

$\exists^{0..n}$ ($n \geq 1$)	$\exists^{0..2}x$	At-most- n quantifier	There is at most n x <i>Note: n is always instantiated by a number ≥ 1. So this is really a set of quantifiers ($n = 1, \text{etc.}$)</i>
$\exists^{n..}$ ($n \geq 1$)	$\exists^{2..}x$	At-least- n quantifier	There is at least n x <i>Note: n is always instantiated by a number ≥ 1. So this is really a set of quantifiers ($n = 1, \text{etc.}$)</i>
\exists^n ($n \geq 1$)	\exists^2x	Exactly- n quantifier	There is at exactly (at least and at most) n x <i>Note: n is always instantiated by a number ≥ 1. So this is really a set of quantifiers ($n = 1, \text{etc.}$)</i>
$\exists^{n..m}$ ($n \geq 1, m \geq 2$)	$\exists^{2..5}x$	Numeric range quantifier	There is at least n and at most m x

The additional existential quantifiers are easily defined in terms of the standard quantifiers.

For example, the exactly-two quantifier \exists^2 may be defined as follows. Let x, x_1, x_2 be individual variables and Φx be a well formed formula with no free occurrences of x_1, x_2 . Then:

$$\exists^2x \Phi x =_{df} \exists x_1 \exists x_2 [\Phi x_1 \ \& \ \Phi x_2 \ \& \ x_1 \neq x_2 \ \& \ \forall y (\Phi y \supset (y = x_1 \vee y = x_2))]$$

Definition schemas for the other quantifiers may be found on page 4-11 of [Halp1989].

The rule formulations covered here may use any of the basic alethic or deontic modal operators shown in Table 24.2. These modal operators are treated as proposition-forming operators on propositions (rather than actions). Other equivalent readings may be used in whatever concrete syntax is used to originally declare the logical rule (e.g., “necessary” might be replaced by “required,” and “obligatory” might be replaced by “ought to be the case”). Derived modal operators may also be used in the surface syntax, but are translated into the basic modal operators plus negation (\sim).

For example, “It is impossible that p ” is defined as “It is not possible that p ” ($\sim\Diamond p$), and “It is forbidden that p ” is defined as “It is not permitted that p ” ($Fp =_{df} \sim Pp$).

Table 24.2 - Modalities

Modality		Modal Formula		applying modal negation rules ... = (Logically Equivalent) Modal Formula	
		Formula	Reading (Verbalized as):	Formula	Reading (Verbalized as):
alethic	necessity	$\Box p$	It is necessary that p	$\sim\Diamond\sim p$	It is not possible that not p
	the negation of necessity: non-necessity	$\sim\Box p$	It is not necessary that p	$\Diamond\sim p$	It is possible that not p
	possibility	$\Diamond p$	It is possible that p	$\sim\Box\sim p$	It is not necessary that not p
	the negation of possibility: impossibility	$\sim\Diamond p$	It is not possible that p It is impossible that p	$\Box\sim p$	It is necessary that not p
	contingency	$\Diamond p \ \& \ \sim\Box p$	It is possible but not necessary that p	$\sim(\sim\Diamond p \vee \Box p)$	It is neither impossible nor necessary that p
deontic	obligation	$O p$	It is obligatory that p	$\sim P\sim p$	It is not permitted that not p
	the negation of obligation: non-obligation	$\sim O p$	It is not obligatory that p	$P\sim p$	It is permitted that not p
	permission	$P p$	It is permitted that p	$\sim O\sim p$	It is not obligatory that not p
	the negation of permission: prohibition	$\sim P p$ $F p$	It is not permitted that p It is prohibited that p It is forbidden that p	$O\sim p$	It is obligatory that not p
	optionality	$P p \ \& \ \sim O p$	It is permitted but not obligatory that p	$\sim(\sim P p \vee O p)$	It is neither prohibited nor obligatory that p

Table Legend:

\Box	necessity	=	logically equivalent
\Diamond	possibility	&	and
O	obligation	v	or (inclusive-or)
P	permission	~	not
F	forbidden	p	some proposition

The following *modal negation rules* apply: it is not necessary that \equiv it is possible that not ($\sim\Box p \equiv \Diamond\sim p$); it is not possible that \equiv it is necessary that not ($\sim\Diamond p \equiv \Box\sim p$); it is not obligatory that \equiv it is permitted that it is not the case that ($\sim\mathbf{O}p \equiv \mathbf{P}\sim p$); it is not permitted that \equiv it is obligatory that it is not the case that ($\sim\mathbf{P}p \equiv \mathbf{O}\sim p$). In principle, these rules could be used with double negation to get by with just one alethic and one deontic operator (e.g., $\Diamond p$ could be defined as $\sim\Box\sim p$, and $\mathbf{P}p$ could be defined as $\sim\mathbf{O}\sim p$).

Every constraint has an associated modality, determined by the logical modal operator that functions explicitly or implicitly as its main operator. We can distinguish between positive, negative, and default verbalizations of constraints. In positive verbalizations, an alethic modality of necessity is often assumed (if no modality is explicitly specified), but may be explicitly prepended.

For example, the following static constraint

C1 **Each** Person was born in **at most one** Country.

may be explicitly verbalized with an alethic modality thus:

C1' **It is necessary that each** Person was born in **at most one** Country.

We interpret this in terms of *possible world semantics*, as introduced by Saul Kripke and other logicians in the 1950s. A proposition is necessarily true if and only if it is true in all possible worlds. With respect to a *static constraint* declared for a given business domain, a possible world corresponds to a *state of the fact model* that might exist at some point in time.

The constraint C1 in the example above means that for each state of the fact model, each instance in the population of Person is born in at most one country.

A proposition is possible if and only if it is true in at least one possible world. A proposition is impossible if and only if it is true in no possible world (i.e., it is false in all possible worlds).

In the example above, constraint C1 may be reformulated as the following negative verbalization:

C1" **It is impossible that the same** Person was born in **more than one** Country.

In practice, both positive and negative verbalizations are useful for validating constraints with domain experts, especially when illustrated with sample populations that provide satisfying examples or counter-examples respectively. The approach described here does not stipulate a high level language for rule verbalization, so many alternative verbalizations may be used.

Many business constraints are deontic rather than alethic in nature. To avoid confusion, we recommend that, when declaring a deontic constraint, the deontic modality always be explicitly included.

Consider the following static, deontic constraint.

C2 **It is obligatory that each** Person is a husband of **at most one** Person.

If this rule were instead expressed simply as “**each** Person is a husband of **at most one** Person,” it would not be obvious that a deontic interpretation was intended. The deontic version indicates a condition that *ought* to be satisfied, while recognizing that the condition *might* not be satisfied. Including the obligation operator makes the rule much weaker than a necessity claim, since it allows that there could be some states of the fact model where a person is a husband of more than one wife (excluding same-sex unions from instances of the husband relationship). For such cases of polygamy, it is important to know the facts indicating that the person has multiple wives. Rather than reject this possibility, we allow it and then typically perform an action that is designed to minimize the chance of such a situation arising again (e.g., send a message to inform legal authorities about the situation).

Constraint C2 may be reformulated as either of the following negative verbalizations:

C2' **It is forbidden that the same** Person is a husband of **more than one** Person.

C2” **It is not permitted that the same** Person is a husband of **more than one** Person.

In practice, most statements of business rules include only one modal operator, and this operator is the main operator of the whole rule statement. For these cases, we simply tag the constraint as being of the modality corresponding to its main operator, without committing to any particular modal logic. Apart from this modality tag, there are some basic modal properties that may be used in transforming the original high level expression of the rule into a standard logical formulation. At a minimum, these include the modal negation rules.

We also make use of equivalences that allow one to move the modal operator to the front of the formula.

For example, suppose the user formulates rule C1 instead as:

For each Person, **it is necessary that that** Person was born in **at most one** Country.

The modal operator is now embedded in the scope of a universal quantifier. To transform this rule formulation to a standard logical formulation that classifies the rule as an alethic necessity, we move the modal operator before the universal quantifier, to give:

It is necessary that each Person was born in **at most one** Country.

For such tasks, we assume that the Barcan formulae and their converses apply, so that \Box and \forall are commutative, as are \Diamond and \exists . In other words:

$$\forall x \Box Fx \equiv \Box \forall x Fx$$

$$\exists x \Diamond Fx \equiv \Diamond \exists x Fx$$

While these commutativity results are valid for all normal, alethic modal logics, some philosophical concerns have been raised about these equivalences (e.g., see sub clauses 4.6-4.8 of [Gir12000]).

As a deontic example, suppose the user formulates rule C2 instead as:

For each Person, it is obligatory that that Person is a husband of at most one Person.

Using a deontic variant of the Barcan equivalences, we commute the \forall and **O** operators, thus transforming the rule formulation into the deontic obligation:

It is obligatory that each Person is a husband of at most one Person.

So far, our rule examples have included just one modal operator, which (perhaps after transformation) also turns out to be the main operator. Ignoring dynamic aspects, we may handle such cases without needing to commit to the formal semantics of any specific modal logic. The only impact of tagging a rule as a necessity or obligation is on the rule enforcement policy. Enforcement of a necessity rule should never allow the necessity rule to be violated. Enforcement of an obligation rule should allow states that do not satisfy the obligation rule, and take some other remedial action: the precise action to be taken is not specified in SBVR, as it is out of scope. At any rate, a business person ought to be able to specify a deontic rule first at a high level, without committing at that time to the precise action to be taken if the condition is not satisfied; of course, the action still needs to be specified later in refining the rule to make it fully operational.

24.2.1.5 Static, Alethic Constraints

Rule formulations may make use of two alethic modal operators: \square = it is necessary that; \diamond = it is possible that. Static constraints are treated as alethic necessities by default, where each state of the fact model corresponds to a possible world..

Given the fact type Person was born in Country, the constraint “**Each Person was born in at most one Country**” may be captured by an SBVR logical formulation that may be automatically translated to the formula $\forall x:\text{Person} \exists^{0..1}y:\text{Country } x \text{ was born in } y$. This formula is understood to be true for each state of the knowledgebase. Pragmatically, the rule is understood to apply to all future states of the fact model, until the rule is revoked or changed. This understanding could be made explicit by prepending the formula with \square to yield the modal formula $\square\forall x:\text{Person} \exists^{0..1}y:\text{Country } x \text{ was born in } y$.

For compliance with Common Logic, formulae such as those in the preceding example could then be treated as irregular expressions, with the modal necessity operator treated as an uninterpreted symbol (e.g., using “[N]” for \square). However we leave this understanding as implicit, and do *not* commit to any particular modal logic.

For the model theory, we omit the necessity operator from the formula. Instead, we merely tag the rule as a necessity. The implementation impact of the alethic necessity tag is that any attempted change that would cause the model of the business domain to violate the constraint must be dealt with in a way that ensures the constraint is still satisfied (e.g., reject the change, or take some compensatory action).

Typically, the only modal operator in an explicit rule formulation is \square , and this is at the front of the rule formulation. This common case was covered earlier. If an alethic modal operator is placed elsewhere in the rule formulation, we first try to “normalize” it by moving the modal operator to the front, using transformation rules such as the modal negation rules ($\sim\square p \equiv \diamond\sim p$; $\sim\diamond p \equiv \square\sim p$) and/or the Barcan formulae and their converses ($\forall x\square\Phi x \equiv \square\forall x\Phi x$ and $\exists x\diamond\Phi x \equiv \diamond\exists x\Phi x$, i.e., \square and \forall are commutative, as are \diamond and \exists).

For example, the embedded formulation “ $\forall x:\text{Person} \square \exists^{0..1}y:\text{Country } x \text{ was born in } y$ ” (**For each Person, it is necessary that that Person was born in at most one Country.**) may be transformed into “ $\square \forall x:\text{Person} \exists^{0..1}y:\text{Country } x \text{ was born in } y$ ” (**It is necessary that each Person was born in at most one Country.**).

We also allow use of the following equivalences: $\square\square p \equiv \square p$; $\diamond\diamond p \equiv \diamond p$; $\square\diamond\square p \equiv \square\diamond p$; $\diamond\square\diamond p \equiv \diamond\square p$. These hold in S4, but not in some modal logics, e.g., K or T [Giri2000, p. 35].

To make life interesting, SBVR also allows a single rule formulation to include multiple occurrences of modal operators, including the nesting of a modal operator within the scope of another modal operator. While this expressibility may be needed to capture some real business rules, it complicates attempts to provide a formal semantics.

In extremely rare cases, a formula for a static rule might contain an embedded alethic modality that cannot be eliminated by transformation. For such cases, we could retain the modal operator in the rule formulation and adopt the formal semantics of a particular modal logic. There are many normal modal logics to choose from (e.g., K, K4, KB, K5, DT, DB, D4, D5, T, Br, S4, S5) as well as many non-normal modal logics (e.g., C2, ED2, E2, S0.5, S2, S3). For a discussion of these logics, and their inter-relationships, see [Giri2000] (esp. pp. 48, 82). For SBVR, if we decide to retain the embedded alethic operator for such cases, we choose S4 for the formal semantics. The possibility of schema evolution along with changes to necessity constraints may seem to violate S4, where the accessibility relationship between possible worlds is transitive, but we resolve this by treating such evolution as a metametalevel concern. Alternatively, we may handle such very rare cases by moving the embedded alethic operators down to domain-level predicates (e.g., is necessary) in a similar fashion to the way we deal with embedded deontics (see later).

24.2.1.6 Static, Deontic Constraints

Constraint formulations may make use of the standard deontic modal operators (**O** = it is obligatory that; **P** = it is permitted that) as well as **F** = it is forbidden that (defined as $\sim P$, i.e., “It is not permitted that”).

If the rule formulation includes exactly one deontic operator, **O**, and this is at the front, then the rule may be formalized as **Op**, where *p* is a first-order formula that is tagged as obligatory (rather than necessary). For the purposes of this sub clause, this tag is assigned only the following informal semantics: it ought to be the case that *p* (for all future states of the fact model, until the constraint is revoked or changed). The implementation impact is that it is possible to have a state in which the rule is violated (i.e., not satisfied), in which case some appropriate action (currently unspecified) ought to be taken to help reduce the chance of future violations.

From a model-theoretic perspective, a model is an interpretation where each *non-deontic* formula evaluates to true, and the model is classified as a *permitted model* if the *p* in each deontic formula (of the form **Op**) evaluates to true, otherwise the model is a *forbidden model* (though it is still a model). Note that this approach removes any need to assign a truth value to expressions of the form **Op**.

For example, suppose the fact type Person is a husband of Person is declared to be many to many, but that each role of this fact type has a deontic uniqueness constraint to indicate that the fact type *ought* to be 1:1. The deontic constraint on the husband fact type role verbalizes as: **It is obligatory that each Person is a husband of at most one Person**. This formalizes as **O** $\forall x:\text{Person} \exists^{0..1}y:\text{Person } x \text{ is a husband of } y$, which may be captured by entering the rule body as $\forall x:\text{Person} \exists^{0..1}y:\text{Person } x \text{ is a husband of } y$ and tagging the rule body as deontic. The other deontic constraint (each wife should have at most one husband) may be handled in a similar way. A more detailed treatment of this example is included in Annex J.

Note that some formulae allowed by SBVR are illegal in some deontic logics (e.g., iterating modal operators such as OPp is forbidden in von Wright's deontic logic), and deontic logic itself is "rife with disagreements about what should be the case" [Gir12000, p. 173].

If a deontic modal operator is embedded later in the rule formulation, we first try to "normalize" the formula by moving the modal operator to the front, using transformation rules such as $p \supset Oq \equiv O(p \supset q)$ or deontic counterparts to the Barcan formulae.

In some cases, a formula for a static rule might contain an embedded deontic modality that cannot be eliminated by transformation. In this case, we still allow the business user to express the rule at a high level using such embedded deontic operators, but *where possible* we transform the formula to a first-order formula without modalities by *replacing the modal operators by predicates at the business domain level*. These predicates (e.g., is forbidden) are treated like any other predicate in the domain, except that their names are reserved, and they are given some basic additional formal semantics to capture the deontic modal negation rules: it is not obligatory that \equiv it is permitted that it is not the case that ($\sim Op \equiv P\sim p$); it is not permitted that \equiv it is obligatory that it is not the case that ($\sim Pp \equiv O\sim p$). For example, these rules entail an exclusion constraint between the predicates is forbidden and is permitted.

This latter approach may also be used as an alternative to tagging a rule body as deontic, thereby (where possible) moving deontic aspects out of the metamodel and into the business domain model.

For example, consider the following rule:

Car rentals ought not be issued to people who are barred drivers at the time the rental was issued.

This deontic constraint may be captured by the following textual constraint on the domain fact type CarRental is forbidden:

CarRental is forbidden **if**

CarRental was issued at Time **and**

CarRental was issued to Person **and**

Person is a barred driver at Time.

The fact type Person is a barred driver at Time is derived from other fact types (Person was barred at Time, Person was unbarred at Time) using the derivation rule:

Person is a barred driver at Time₁ **iff**

Person was barred at a Time₂ <= Time₁ **and**

Person was **not** unbarred at a Time₃ **between** Time₂ **and** Time₁.

The deontic constraint may be formalized by the first-order formula: $\forall x:\text{CarRental} \forall y:\text{Person} \forall t:\text{Time} [(x \text{ was issued at } t \ \& \ x \text{ was issued to } y \ \& \ y \text{ is a barred driver at } t) \supset x \text{ is forbidden}]$. This schema allows for the possible existence of forbidden car rentals; if desired, some fact types could be added to describe actions (e.g., sending messages) to be taken in reaction to such an event.

As a second example, consider the following deontic rule:

It is forbidden that more than three people are on the EU-Rent Board.

Suppose the underlying schema includes the fact type: Person is on Board. This may be used to define the derived fact type Board has NrMembers using the derivation rule: nrMembers **of** Board = **count each** Person **who** is on Board. Objectify this derived fact type as BoardHavingSize, and then add the fact type BoardHavingSize is forbidden. The deontic constraint may now be captured by the following textual constraint on the derived fact type:

BoardHavingSize is forbidden **if**

BoardHavingSize is of a Board

that has BoardName 'EU-Rent Board'

and has NrMembers > 3.

As a third example, our earlier schema for current marriage may be recast by objectifying the fact type Person is a husband of Person as CurrentMarriage, and recognizing the link fact types Person is a husband in CurrentMarriage and Person is a wife in CurrentMarriage. The deontic constraints may now be formulated as textual constraints on the fact type CurrentMarriage is forbidden as follows:

CurrentMarriage is forbidden if

a Person₁ **who** is a husband in CurrentMarriage

is a husband of **more than one** Person₂.

CurrentMarriage is forbidden if

a Person₁ **who** is a wife in CurrentMarriage

is a wife of **more than one** Person₂.

Extended treatments of the examples above are provided in Annex J.

The approach to objectification described here works for those cases where a fact (proposition taken to be true) is being objectified (which covers the usual cases of nominalization, including the EU-Rent Board and current marriage examples discussed earlier), but it does not handle cases where no factual claim is being made of the proposition.

SBVR is intended to cater for rules that embed possibly non-factual propositions. However, there does not appear to be any simple solution to providing explicit, formal semantics for such rules.

As a nasty example, consider the following business rule:

It is not permitted that some department adopts a rule that says it is obligatory that each employee of that department is male.

This example includes the mention (rather than use) of an open proposition in the scope of an embedded deontic operator. One possible, though weak, solution is to rely on reserved domain predicates to carry much of the semantics implicitly. For example, suppose the schema includes the following fact types: Person is male; Person works for Department; Department adopts Logic Rule. Objectify Department adopts Rule as RuleAdoption, and add the following fact types: RuleAdoption is forbidden; Rule obligates the actualization of PossibleAllMaleState; PossibleAllMaleState is actual. This uses the special predicates “obligates the actualization of” and “is actual,” as well as a type of individual “PossibleAllMaleState” which includes all conceivable all-male-states of departments, whether actual or not. The derived fact type PossibleAllMaleState is actual may be defined using the derivation rule:

PossibleAllMaleState is actual **iff**
PossibleAllMaleState is of **a** Department **and**
each Person **who** works for **that** Department is male.

i.e., $\forall x:\text{PossibleAllMaleState} [x \text{ is actual} \equiv \exists y:\text{Department} (x \text{ is of } y \ \& \ \forall z:\text{Person} (z \text{ works for } y \supset z \text{ is male}))]$.
The deontic constraint may now be captured by the following textual constraint on the fact type RuleAdoption is forbidden:

RuleAdoption is forbidden **if**
RuleAdoption is by **a** Department
and is of **a** Rule
that obligates the actualization of **a** PossibleAllMaleState
that is of **the same** Department.

i.e., $\forall x:\text{RuleAdoption} \ \forall y:\text{Department} \ \forall z:\text{Rule} \ \forall w:\text{PossibleAllMaleState} [(x \text{ is by } y \ \& \ x \text{ is of } z \ \& \ z \text{ obligates the actualization of } w \ \& \ w \text{ is of } y) \supset x \text{ is forbidden}]$

The formalization of the deontic constraint works, because the relevant instance of PossibleAllMaleState exists, regardless of whether or not the relevant depart actually is all male. The “obligates the actualization of” and “is actual” predicates embed a lot of semantics, which is left implicit. While the connection between these predicates is left informal, the derivation rule for PossibleAllMaleState is actual provides enough semantics to enable human readers to understand the intent. An extended treatment of this example is provided in Annex J.

Alternatively, we could capture the structure of the rule using the current semantic formulation machinery, and then adopt one of two extremes: (1) treat the rule overall as an uninterpreted sentence, or informal comment, for which humans are to provide the semantics; (2) translate the semantic formulation directly into higher-order logic, which permits logical formulations (which connote propositions) to be predicated over. The complexity and implementation overhead of option (2) would seem to be very substantial.

We could try to push such cases down to first-order logic by providing the equivalent of the semantic formulation machinery as a predefined package that may be imported into a domain model, and then identifying propositions by means of a structured logical formulation. But that seems a fudge, because in order to assign formal semantics to such expressions, we must effectively adopt the higher-order logic proposal mentioned in the previous paragraph.

Pat Hayes has indicated his intent to add support for reification as an extension to Common Logic at some future date. This support is intended to cater for objectification of propositions that are already being asserted as facts (i.e., propositions being used), as well as propositions for which no factual claim is made (i.e., propositions being mentioned). When available, his treatment for the latter case may offer a better solution for the problem under consideration. His intent is to allow quantification and predication over propositions (or expressions that declare propositions), regardless of whether truth claims are being asserted of those propositions, while still retaining a first-order approach. We might be able to adopt whatever he proposes in this regard to provide a formal semantics for such problematic rules.

24.2.1.7 Derivation Rules

The formal interpretation of SBVR presented here supports rules for deriving types of individuals (subtype definitions) or fact types using either ‘if-and-only-if’ (equivalence) formulations for full derivation, or ‘if’ for partial derivation. A subtype may be fully derived (defined in terms of fact type roles played by its supertype), asserted (without a derivation rule), or partly derived.

Here is one simple example of each kind of derivation rule, stated first using a high-level textual language, as described earlier, and then recast as a predicate logic formula. The transformation from a semantic formulation structure in a high level language into predicate logic is straightforward.

Derivation rule for fully derived subtype:

Each Australian is a Person who was born in Country ‘AU.’

$\forall x [\text{Australian } x \equiv (\text{Person } x \ \& \ \exists y:\text{Country } \exists z:\text{CountryCode } (x \text{ is a citizen of } y \ \& \ y \text{ has } z \ \& \ z = \text{'AU'}))]$

Derivation rule for partly derived subtype:

Person₁ **is a Grandparent if** Person₁ is a parent of **some** Person₂ who is a parent of **some** Person₃.

$\forall x:\text{Person } [\text{Grandparent } x \subset \exists y:\text{Person } \exists z:\text{Person } (x \text{ is a parent of } y \ \& \ y \text{ is a parent of } z)]$

Derivation rule for fully derived fact type:

Person₁ is an uncle of Person₂ **iff** Person₁ is a brother of **some** Person₃ **who** is a parent of Person₂.

$\forall x:\text{Person } \forall y:\text{Person } [x \text{ is an uncle of } y \equiv \exists z:\text{Person } (x \text{ is a brother of } z \ \& \ z \text{ is a parent of } y)]$

Derivation rule for partly derived fact type:

If a Patient smokes then that Patient is cancer-prone.

$\forall x:\text{Patient } (\text{smokes } x \supset \text{cancer-prone } x)$

24.2.1.8 Dynamic Constraints

Dynamic constraints apply restrictions on possible transitions between business states. The constraint may simply compare one state to the next.

Salaries should never decrease.

Alternatively, the constraint may compare states separated by a given period.

Invoices ought to be paid within 30 days of being issued.

The invoice rule might be formally expressed in a high level rules language thus, assuming the fact types Invoice was issued on Date and Invoice is paid on Date are included in the conceptual schema:

**For each Invoice, if that Invoice was issued on Date₁
then it is obligatory that
that Invoice is paid on Date₂ where Date₂ <= Date₁ + 30 days.**

This might now be normalized to the following formulation, moving the deontic operator to the front:

**It is obligatory that each Invoice that was issued on Date₁ is paid on Date₂
where Date₂ <= Date₁ + 30 days.**

There are two issues here. First, what transformation rules did we rely on to license the transformation of the rule? It would seem that we require an equivalence rule such as $p \supset \mathbf{O}q \equiv \mathbf{O}(p \supset q)$. While this formula is actually illegal in some deontic logics, it does seem intuitively acceptable. At any rate, the preliminary transformation work in normalizing a rule formulation might involve more than just the Barcan equivalences or their deontic counterparts. In principle, this issue might be ignored for interoperability purposes, so long as the business domain expert is able to confirm that the final, normalized formulation (perhaps produced manually by the business rules modeler) agrees with their intended semantics; it is only the final, normalized formulation that is used for exchange with other software tools.

The second issue concerns the dynamic nature of the rule. While it is obvious how one may actually implement this logical rule in a database system, capturing the formal semantics in an appropriate logic (e.g., a temporal or dynamic logic) is a harder task. One possibility is to provide a temporal package that may be imported into a domain model, in order to provide a first-order logic solution. Another possibility is to adopt a temporal modal logic (e.g., treat a possible world as a sequence of accessible states of the fact model). It may well be reasonable to defer decisions on formal semantics for dynamic rules to a later version of the SBVR standard.

24.2.1.9 Higher-order Logic

Currently, SBVR allows users to either stay with first-order logic, or adopt higher-order logic restricted to Henkin semantics (e.g., for dealing with categorization types). In general, standard higher-order logic allows quantification over uncountably many possible predicates (or functions). If D = the domain of individuals, then the range of any unary predicate variable R is the entire power set $P(D)$ (i.e., the set of all subsets of D), the range of any binary predicate variable is the Cartesian product $P(D) \times P(D)$, and so on for higher arity predicates. If D includes a denumerable (countable infinite, i.e., $|D| = \aleph_0$) set, such as the natural numbers, then $P(D)$ is uncountably infinite. In contrast, Henkin semantics restricts quantifiers to range over only individuals and those predicates (or functions) that are specified in the universe of discourse (a.k.a. business domain), where the n -ary predicates/functions ($n > 0$) range over a fixed set of n -ary relations/operations. By restricting the ranges of predicate and function variables, the Henkin interpretation retains certain desirable first-order properties (e.g., completeness, compactness, and the Skolem-Löwenheim theorems) that are lost in the standard interpretation of higher-order logic.

Common Logic adopts the Henkin restriction on quantifier ranges, but does not adopt the Axiom of Comprehension, which states that for each property there exists a set of elements having that property, i.e., for any formula $\varphi(x)$ where x (possibly a vector) is free in φ , $\exists A \forall x [x \in A \equiv \varphi(x)]$. The intent of the Comprehension axiom (to ensure that every formula specifies a set) may also be achieved by using lambda abstraction to name the set, e.g., $\lambda x. \varphi(x)$, which is equivalent to the set comprehension $\{x \mid \varphi(x)\}$. The Axiom of Comprehension leads to Russell's paradox (substituting $x \notin x$ for $\varphi(x)$ generates a contradiction since $\{x \mid x \notin x\}$ is simultaneously a member of itself and not a member of itself). The paradox may be avoided either by rejecting the

comprehension axiom (e.g., replacing it by the weaker axiom of separation, as in Zermelo-Fraenkel set theory) or by restricting the language so that formulae such as $x \notin x$ are illegal (as in Russell's type theory, where a set may belong only to a set of higher order).

Here we use set comprehensions (in a restricted sense) to define projections on schema path expressions, as a way to specify result sets.

For example, given the fact type Employee(EmpNr) works for Company(Name), the query "Who works for Microsoft?" corresponds to the following set comprehension:

$$\{x:\text{Employee} \mid \exists y:\text{Company}; z:\text{CompanyName} (x \text{ works for } y \ \& \ y \text{ has } z \ \& \ z = \text{'Microsoft'})\}$$

The formal semantics of such conceptual queries is based on that of the Conquer language, which provides a sugared version of sorted finitary first-order logic with set comprehension [Anto2001].

The use here of set comprehension is quite restricted. Any expression we use to define a set must ultimately be expressible only in terms of some basic logical operators (e.g., $\&$) as well as predefined ground fact types which must be either elementary or existential. Hence we adopt a limited version of the axiom of comprehension. Common Logic is open to extensions that adopt restricted versions of the comprehension axiom. To avoid Russell's paradox, we treat formulae such as $x \notin x$ as illegal. The "is an instance of" predicate caters for set membership, but is constrained to be irreflexive, and the formation rules do not permit expressions of the form $x \in x$ – in other words, we cannot make statements involving self-membership. We do not adopt a type theory such as Russell's type theory, where each set may belong only to a set of a higher type.

The decision on whether to use higher-order types mainly impacts the following three aspects of fact modeling: categorization schemes, un-normalized structures, and crossing levels/metalevels within the same model. In [Halp2004], some ways are suggested to avoid higher-order types, by treating types as intensional individuals whose instances may sometimes be in 1:1 correspondence (but not identical) to subtypes, by requiring subtype definitions to be informative, by remodeling (including demotion of metadata to data), and by treating types as individuals in separate models. For further discussion, see [Halp2004].

Acknowledgement: We gratefully acknowledge the assistance of Pat Hayes (<http://www.ihmc.us/users/user.php?UserID=phayes>) in addressing some of the logical semantics topics in this document.

24.2.2 Formal Logic & Mathematics in General

Formal Logic and Mathematics Vocabulary

Language: [English](#)

acceptable world

Definition: any state (situation) of some given universe of discourse (domain) that is implicitly characterized, by someone with legal authority over that domain, as consistent with some set of goals of that authority pursued by exercise of that authority

actual world

- Definition: the possible world that is taken to be actual for some purpose, in particular, for the conduct of business and the application of business rules
- Note: the actual world is a set of things, situations and facts about them that some person or organization takes to be true for some purpose. In most cases, it is the best estimate of the actual state of the world that is of interest at a particular time.

alethic modality

- Source: CDP
- Definition: Historically, any of the five central ways or modes in which a given proposition might be true or false: [necessity](#) (and [non-necessity](#)), [possibility](#) (and [impossibility](#)), and [contingency](#)
- Note: (1) Although these “modes” have historically been thought of as ways in which a proposition might be true, we think of them as ways in which one might think of the truth of a proposition: e.g., that a proposition be qualified with the alethic modality “necessity” does not imply it is a fact, but only signifies that the semantic community is considering it (takes it to be) necessarily true. For some issues arising from the former approach, cf. CDP, s.v. *intensional logic*. For a thorough critique of it, see PEIL. The four “modal negation equivalences” (MLP, p. 3), such as $\Box p \equiv \sim \Diamond \sim p$, still hold under the latter approach (cf. LEVS, p. 135), which is the more useful one in the fields of linguistic semantics and linguistic pragmatics.
- Note: (2) The four alethic modalities which we consider most basic, and to which the four “modal negation equivalences” (MLP, p. 3) apply, are [necessity](#), [possibility](#), and their respective negations ([non-necessity](#) and [impossibility](#)). We also define a fifth modality, [contingency](#) for the idea “neither impossible nor necessary.” (CDP)
- Note: (3) Alethic modal logic differs from deontic modal logic in that the former deals with people’s estimate(s) of the possible truth of some proposition, whereas deontic modal logic deals with people’s estimate(s) of the social desirability of some particular party’s making some proposition true.

antecedent

- Source: adapted from GFOL
- Definition: The [wff](#) in [or more specifically, the proposition-[wff](#) in or else the proposition denoted by] the if-clause of an [implication](#).
- Note: Interpolation ours. Otherwise the definition is from GFOL.

argument

- Source: GFOL
- Definition: a [logical-] subject-term for a [predicate](#).
- Note: Interpolation in square brackets ours. By “logical subject” we mean an object playing a role (i.e., an object filling an object hole) in a logical predicate. Thus there may be one or more logical-subject-terms in a logical predicate.

arity

- Source: IMRD (pp. 10, 64)
- Definition: A logical predicate’s number of roles (i.e., of object holes).
- Note: A function may be thought of as a relation; accordingly, we treat a function as a logical predicate. MATH defines arity of a function thus: “The number of arguments taken by

something, usually applied to functions: an n -ary function is one with an arity of n , i.e., it takes n arguments. Unary is a synonym for 1-ary, and binary is a synonym for 2-ary.”

atomic formula

- Source: GFOL [“atom”]
- Definition: In predicate logic, a wff without quantifiers or connectives.
- Note: (1) This definition is from the cited source s.v. atom, which we deem a synonym.
- Note: (2) LSO says of atomic formula: “The simplest sort of wff of a formal language; an atomic formula of the language of predicate logic is a predicate letter followed by zero or more name letters.” Yet it can also be a propositional variable or a propositional constant, depending on context.

consequent

- Source: GFOL
- Definition: The wff in [or more specifically, the proposition-wff in or else the proposition denoted by] the then-clause of an implication.
- Note: Interpolation ours.

contingency

- Definition: alethic modality that is the conjunction of possibility and non-necessity
- Note: Contingency (“it is possible but not necessary that p ”) is the modal equivalent of “it is neither impossible nor necessary that p ”: $(\Diamond p \ \& \ \sim \Box p) \equiv \sim (\sim \Diamond p \vee \Box p)$.

deontic modality

- Source: CDP [“deontic operator”]; LEVS (pp. 276-77); LSO (p. 302); MLP (pp. 170-76)
- Definition: Any of the five central ways or modes in which one might think of the social desirability of a certain other person(s)’s making true some proposition, that is, the social desirability that the act(s) be performed, by a certain other person(s), that would make the proposition true; viz., obligation (and its negation, non-obligation), permission (and its negation, nonpermission (forbidden/prohibition)), and optionality.
- Note: (1) The definition given is not quoted directly from any source, since we have not found the term defined as such anywhere. Rather, we have based our definition on passages mainly in the above-cited sources.
- Note: (2) Alethic modal logic differs from deontic modal logic in that the former deals with people’s estimate(s) of the possible truth of some proposition, whereas deontic modal logic deals with people’s estimate(s) of the social desirability of some particular party’s making some proposition true.
- Note: (3) The four deontic modalities that we consider most basic, and to which the four “modal negation equivalences” apply, are obligation, permission, and their respective negations (non-obligation and prohibition). We also define a fifth modality, optionality, for the idea “neither prohibited nor obligatory.”

domain

- Source: GFOL
- Definition: Of an interpretation of a formal language of predicate logic, the set of objects that may serve as the assigned referents of the constants of the language, the arguments of functions, and the arguments of predicates.

domain grammar

- Source: META (p. 4); HALT89 (sec. 3.2); IMRD (pp. 27-30)
- Definition: The formation rules determining what is a wff in a given domain-specific formal language.
- Note: Another term for that which is called in ORM “conceptual schema.” The definition given above is not quoted directly from any source, since we have not found the term defined as such anywhere. Rather, we have based our definition on passages mainly in the above-cited sources.

elementary verb concept

- Definition: verb concept whose facts cannot be split into smaller units of information that collectively provide the same information as the original
- Concept Type: role
- Example: branch has storage capacity
- Example: service depot is included in local area
- Example: rental car has fuel level at date/time
- Example: Counter-example (this would *not* be considered an elementary verb concept): car manufacturer delivers consignment to branch. This is not elementary because a consignment is always from at most one car manufacturer and is always to at most one branch. So the counter-example is equivalent to the combination of two binary verb concepts: car manufacturer delivers consignment and consignment is delivered to branch.

fact type

- Definition: set of all possible facts of a given kind that, in logical terms, corresponds to a set of one or more typed predicates that are semantically interchangeable except that the order of arguments may vary
- Example: In prefix notation the typed predicates drives(Person,Car), isDrivenBy(Car, Person), and isaDriverOf(Person, Car) could each be used for the same fact type.

first-order instance

- Source: GFOL
- Definition: The objects or elements taken as the [logical] subjects of the predicates of first-order predicate logic.
- Definition: [CLARIFIED DEFINITION] object or element taken as a logical subject of a predicate of first order logic.
- Note: And the distinguishing characteristic of “first-order” predicate logic, in turn, is the additional restriction, re the formation of wffs, that subjects of predicates cannot themselves be types or predicates, but rather only individuals (or individual-constants, individual-variables, or function-expressions). See first-order type.

first-order type

- Source: LSO (pp. 280-84) [and “type system”]; META (p. 140); TTGG (p. 5)
- Definition: A type whose extension includes no types or predicates, only first order instances, in accordance with the grammatical restrictions in first-order predicate logic.
- Note: The definition given is not quoted directly from any source, since we have not found the term defined as such anywhere. Rather, we have based our definition on passages mainly in the above-cited sources.

formal model

- Source: based on GFOL ["model"]; META (pp. 5,6, 148-49)
- Definition: An *interpretation* supplies semantics (referents) for a given formal language, in relation to some domain or universe. It specifies referents for the nonlogical symbols occurring in the formal language. A *formal model* of a given wff or set of wffs in a formal language is an interpretation of the language for which the wffs are considered true.

implication

- Source: GFOL
- Definition: expression of the form, "if A, then B," when A and B stand for wffs or propositions. The wff in the if-clause is called the antecedent (also the implicans and protasis). The wff in the then-clause is called the consequent (also the implicate and apodosis). Also called a conditional, or a conditional statement.
- Note: In SBVR we treat "implication" as if it is "material implication" (i.e., ' $p \rightarrow q$ ' is equivalent to ' $\sim p \vee q$ ').

impossibility

- Definition: alethic modality that is the negation of possibility
- Note: A *derived modal operator* for 'impossibility' may be used in the surface syntax, but it is translated into the basic modal operator for 'possibility' plus negation (\sim) (i.e., "It is impossible that p " is defined as "It is not possible that p ": $\sim\Diamond p$).
- Note: Impossibility ("it is impossible that p ") is the modal equivalent of "it is necessary that not p ": $\sim\Diamond p \equiv \Box \sim p$.

integer

- Source: GFOL ["integers"]
- The natural numbers supplemented by their negative counterparts. The set $\{\dots-3, -2, -1, 0, 1, 2, 3\dots\}$.

logical variable

- Source: GFOL
- Definition: A symbol whose referent varies or is unknown. A place-holder, as opposed to an abbreviation or name (a constant).
- Note: This definition is from the cited source s.v. variable, which we deem a synonym.

member

- Source: DEAN (p. 6); GFOL ["membership"]
- Definition: An element belonging to a set.
- Note: The definition given is not quoted directly from any source, since we have not found the term defined as such anywhere. Rather, we have based our definition on passages mainly in the above-cited sources.

modal logic

- Source: SEP
- Definition: Narrowly construed, modal logic studies reasoning that involves the use of the expressions 'necessarily' and 'possibly.' However, the term 'modal logic' is used more broadly to cover a family of logics with similar rules and a variety of different symbols.

necessity

- Source: CDP
- Definition: A modal property that qualifies an assertion of a whole proposition just when it is not considered possible that the proposition is false.
- Note: The definition given is not quoted directly from any source. Rather, we have based our definition on passages mainly in the above-cited source. See also [alethic modality](#)
- Note: Necessity (“it is necessary that p ”) is the modal equivalent of “it is not possible that not p ”: $\Box \equiv \sim \Diamond \sim p$.
- Note: The following *modal negation rules* apply:
“it is not necessary that p ” \equiv “it is possible that not p ”: $\sim \Box p \equiv \Diamond \sim p$. See [non-necessity](#)

non-necessity

- Definition: [alethic modality](#) that is the negation of [necessity](#)
- Note: Non-necessity (“it is not necessary that p ”) is the modal equivalent of “it is possible that not p ”: $\sim \Box p \equiv \Diamond \sim p$

non-obligation

- Definition: [deontic modality](#) that is the negation of [obligation](#).
- Note: Non-obligation (“it is not obligatory that p ”) is the modal equivalent of “it is permitted that not p ”: $\sim Op \equiv P \sim p$.

obligation

- Source: CDP [“deontic logic”]; MLP (pp. 170-76)
- Definition: One of the four main [deontic modalities](#), which qualifies as socially obligatory the making true a certain proposition (i.e., the doing a certain act) by a certain party or parties.
- Note: The definition given is not quoted directly from any source, since we have not found the term defined as such anywhere. Rather, we have based our definition on passages mainly in the above-cited sources.
- Note: Obligation (“it is obligatory that p ”) is the modal equivalent of “it is not permitted that not p ”: $Op \equiv \sim P \sim p$
- Note: The following modal negation rules apply:
“it is not obligatory that p ” \equiv “it is permitted that not p ”: $\sim Op \equiv P \sim p$. See [non-obligation](#).

optionality

- Definition: [deontic modality](#) that is the conjunction of [permission](#) and [non-obligation](#)
- Note: Optionality (“it is permitted but not obligatory that p ”) is the modal equivalent of “it is neither prohibited nor obligatory that p ”: $(Pp \ \& \ \sim Op) \equiv \sim (\sim Pp \ \vee \ Op)$.

permission

- Source: CDP [“deontic logic”]; MLP (pp. 170-76)
- Definition: One of the four main [deontic modalities](#), which qualifies as socially permissible the making true a certain proposition (i.e., the doing a certain act) by a certain party or parties.
- Note: The definition given is not quoted directly from any source, since we have not found the term defined as such anywhere. Rather, we have based our definition on passages mainly in the above-cited sources.

Note: Permission (it is permitted that p) is the modal equivalent of “it is not obligatory that not p ”: $Pp \equiv \sim O\sim p$.

Note: The following modal negation rules apply:
“it is not permitted that p ” \equiv “it is obligatory that not p ”: $\sim Pp \equiv O\sim p$. See [prohibition](#).

population

Source: IMRD (p. 164)

Definition: The extension of a [type](#) (whether type of individual, fact type, or role) for a given state of the business domain.

possibility

Source: CDP

Definition: A modal property that qualifies an assertion of a whole proposition just when it is considered possible that the proposition is true.

Note: The definition given is not quoted directly from any source. Rather, we have based our definition on passages mainly in the above-cited source. See also [alethic modality](#)

Note: Possibility (“it is possible that p ”) is the modal equivalent of “it is not necessary that not p ”: $\Diamond p \equiv \sim \Box \sim p$.

Note: The following *modal negation rules* apply:
“it is not possible that p ” \equiv “it is necessary that not p ”: $\sim \Diamond p \equiv \Box \sim p$. See [impossibility](#).

possible world

Definition: any state (situation) of some given universe of discourse (domain) that is implicitly characterized, by an accepted expert on that domain, as logically consistent with some set of laws seen by that expert as applying to that domain

Note: “Possible world” means “logically possible world,” and not “physically possible world.” Included within the sense of “possible world” is any “possible situation;” therefore, the notion includes the “possible states” of any given set of objects [[things](#)] of interest - which set is commonly called the “Universe of Discourse” (or “UoD”), a.k.a. the “domain” (or “business domain”). Thus, in the context of a static constraint declared for a given business domain, a “possible world” would correspond to (but not be identical to) a state of the domain’s fact model that could exist at some point in time, which is the “present time” of the possible world.

predicate

Source: GFOL

Definition: Intuitively, whatever is said of the subject[s] of a sentence - function from individuals (or a sequence of individuals) to truth-values

Note: Interpolation in square brackets ours. A predicate is distinguished from others by sentence structure, not by proposition/meaning (see IMRD, pp. 63-66). Propositions or meanings distinguish fact types, each of which may have 1 or more predicates.

prohibition

Source: CDP [“deontic logic”]; MLP (pp. 170-76)

Definition: One of the four main [deontic modalities](#) nonpermissibility, which qualifies as socially not permissible the making true a certain proposition (i.e., the doing a certain act) by a certain party or parties

Definition: [deontic modality](#) that is the negation of [permission](#)

- Note: See also [permission](#). The definition given is not quoted directly from any source, since we have not found the term defined as such anywhere. Rather, we have based our definition on passages mainly in the above-cited sources.
- Note: A *derived modal operator* for ‘prohibition’ may be used in the surface syntax, but it is translated into the basic modal operator for ‘permission’ plus negation (\sim). (i.e., “It is prohibited that p ” is defined as “It is not permitted that p ”: $\sim Pp$).
- Note: A *derived modal operator* for ‘forbidden’ may be used in the surface syntax, but it is translated into the basic modal operator for ‘permission’ plus negation (\sim). (i.e., “It is forbidden that p ” (Fp) is defined as “It is not permitted that p ”: $\sim Pp$).
- Note: Prohibition (“it is prohibited that p ”) is the modal equivalent of “it is obligatory that not p ”: $\sim Pp \equiv O\sim p$.

proposition

- Source: DL (p. 4)
- Definition: That which is asserted when a sentence is uttered or inscribed
- Note: Generally understood as “the meaning of” a declarative sentence. GFOL defines it thus: “In logic generally (for some), the meaning of a sentence that is invariant through all the paraphrases and translations of the sentence.”

propositional operator

- Source: PLTS
- Definition: An operator (or connective) joins ... statements [i.e., propositions or proposition-[wffs](#)] into compounds.... Connectives include conjunction, disjunction, implication and equivalence. Negation is the only operator that is not a connective; it affects single statements [i.e., propositions or proposition-[wffs](#)] only, and does not join statements [i.e., propositions or proposition-[wffs](#)] into compounds.
- Note: By “proposition-[wff](#)” we mean a proposition-constant or proposition-variable, or a predicate supplied with arguments so as to yield a proposition.

quantifier

- Source: GFOL
- Definition: In predicate logic, a symbol telling us ... how many objects (in the domain) [instantiate] the predicate.... The quantifier applies to, or binds, variables which stand as the [arguments](#) of [predicates](#). In first-order logic these variables must range over [individuals](#); in higher-order logics they may range over [predicates](#).
- Note: Interpolation in square brackets ours.

restricted higher-order instance

- Source: HALT2004 (pp. 2-4, 7); MEN97 (pp. 378-80)
- Definition: instance of a [restricted higher-order type](#)
- Note: The definition given is not quoted directly from any source, since we have not found the term defined as such anywhere. Rather, we have based our definition on passages mainly in the above-cited sources.

restricted higher-order type

- Source: HALT2004 (pp. 2-4, 7, 8); MEN97 (pp. 378-80)
- Definition: A *higher-order type* includes an instance that is itself a [type](#). For SBVR, we *restrict higher-order types* to Henkin semantics, limiting the range of [predicates](#)/functions over which we may quantify to a fixed [set](#), rather than allowing full range over power-sets. This restriction retains useful properties of first-order logic (e.g., completeness).
- Note: The definition given is not quoted directly from any source, since we have not found the term defined as such anywhere. Rather, we have based our definition on passages mainly in the above-cited sources.

set

- Source: GFOL
- Definition: Intuitively, a collection of elements (called [members](#)). In a set, the order of [members](#) is irrelevant, and repetition of [members](#) is [also irrelevant]. The intuitive notion of a set leads to paradoxes, and there is considerable mathematical and philosophical disagreement on how best to refine the intuitive notion.
- Note: Interpolation in square brackets ours.

state of affairs

- Source: CDP
- Definition: A possibility, actuality or impossibility of the kind expressed by a nominalization of a declarative sentence (e.g., “This die comes up six” may be nominalized by “that this die comes up six” or “this die’s coming up six”) the resulting nominalizations might be interpreted as naming corresponding propositions or states of affairs

subset

- Source: GFOL
- Definition: [set](#) all of whose members belong to a second [set](#) (a superset of the subset)

type

- Source: adapted from HALT2004 (p. 8); cf. TTGG (p. 84)
- Definition: named [set](#) of possible instances, where for any given state of the business domain, exactly one [subset](#) of the type is the [population](#) of the type in that state
- Note: At any given time, the [population](#) of a type is the set of instances of that type that exist in the business domain (i.e., that are referenced within facts that are known and are of interest to the business) at that time. It follows that if two types are equal, then for each state of the business domain they must have the same population.
- Note: “Possible instances” here means “instances which are considered part of the type’s population, for some state of the business domain.”
- Note: Because it is a formal object that behaves quite differently in first-order predicate logic than in second-order predicate logic (and differently still in third order, and so on), the definition of “type” proves to be anaphoric, having a different denotation depending on whether, in the situation where used, the intended formalization is first-order, second-order, or other-order. In our definitions of [first-order type](#) and [restricted higher order type](#), at least some of this indefiniteness is removed (by the specifying of either first-order logic or restricted higher-order logic).

type of individual

Definition: [type](#) that is a set of possible individuals; kind of individual thing, e.g., Planet, CountryCode

unbound variable

Source: GFOL

Definition: free variable [which, in GFOL, is defined thus:] in predicate logic, an individual variable at least one of whose occurrences in a [wff](#) does not lie within the scope of a [quantifier](#) on the same letter

Universe of Discourse

Definition: set of objects [[things](#)] of interest, including their states, relationships, and situations and forming the context of a given discussion

wff

Source: GFOL

Definition: (acronym of “well-formed formula”) - a string of symbols, each from the alphabet of a formal language, that conforms to the grammar of the formal language; in predicate logic, a closed [wff](#) is a [wff](#) with no free occurrences of any variable; either it has constants in place of variables, or its variables are bound, or both (also called a sentence); an open [wff](#) is a [wff](#) with at least one free occurrence of a variable

world

Source: CSILL

Definition: a universe, whether real, imaginary, or hypothetical

Note: From CSILL: The truth-conditional approach to meaning allows model theory to be extended to the study of natural languages. Sentences and their parts are mapped on to elements of a model, which represents the truth-conditions for the sentences. In possible world semantics, models are not restricted to domains of real entities but include possible objects; that is, model theory can provide truth-conditions in terms of possible worlds, thus allowing meaningful expressions without requiring ontological commitment.

24.2.2.1 Conceptual Schemas and Models

conceptual schema

Definition: combination of concepts and facts (with semantic formulations that define them) of what is possible, necessary, permissible, and obligatory in each possible world

conceptual schema includes concept

Definition: [the concept](#) is used in models based on [the conceptual schema](#)

Synonymous Form: [concept is in conceptual schema](#)

Necessity: [Each role of each fact type that is in a conceptual schema is in the conceptual schema.](#)

conceptual schema includes fact

Definition: [the fact](#) determines something possible, necessary, permissible, or obligatory in each possible world that can be modeled based on [the conceptual schema](#)

Synonymous Form: [fact is in conceptual schema](#)

fact type is internally closed in conceptual schema

- Definition: in each [fact model](#) based on [the conceptual schema](#), for each instance of [the fact type](#), the [fact model](#) includes a corresponding fact if, for each thing filling any of the fact type's roles in the instance, the [fact model](#) also includes a fact of the existence of that thing
- Synonymous Form: [fact type is semi-closed in conceptual schema](#)
- Note: Open world semantics are assumed by default, but closure may be explicitly asserted for any fact type, on an individual basis, to declare that each fact model population agrees with that of the fact type's extension in the actual business domain. Semi-closure is with respect to the domain model population of the noun concepts playing a role in the fact type. In other words, if the things participating in a fact are known within a model, then the fact is also known within that model.

concept is closed in conceptual schema

- Definition: in each [fact model](#) based on [the conceptual schema](#), the entire extension of [the concept](#) is given in the facts included in the [fact model](#)
- Necessity: [Each concept that is closed in a conceptual schema is in the conceptual schema.](#)
- Note: A concept can be closed in one conceptual schema and not in another.

fact model

- Definition: combination of a conceptual schema and, for one possible world, a set of facts (defined by semantic formulations using only the concepts of the conceptual schema)
- Synonym: [conceptual model](#)
- Note: Each necessity of the conceptual schema is satisfied by a fact model, but obligations are not necessarily satisfied.

fact model is based on conceptual schema

- Definition: [the conceptual schema](#) provides the concepts and modal facts of [the fact model](#)
- Synonymous Form: [conceptual schema underlies fact model](#)

fact model includes fact

- Definition: [the fact](#) corresponds to an actuality in the possible world modeled by [the fact model](#)
- Synonymous Form: [fact is in fact model](#)

fact type has fact in fact model

- Definition: [the fact is in the fact model](#) and [the fact corresponds to an instance of the fact type](#)

fact type is elementary in conceptual schema

- Definition: [the fact type](#) is in [the conceptual schema](#) and cannot be decomposed into a set of two or more [fact types](#) that are in [the conceptual schema](#) and that collectively have the same meaning as [the fact type](#)
- Synonymous Form: [conceptual schema](#) has [elementary fact type](#)

24.3 Formal Logic Interpretation Placed on SBVR Terms

This clause specifies how the SBVR concepts in the table below, as defined in Clauses 8 through 21, are to be interpreted in terms of formal logic as defined in ISO 24707 "Information technology - Common Logic (CL) - A framework for a family of logic-based languages." Equivalent concepts in OWL are also shown in the table where possible.

The ISO 24707 interpretation of SBVR concepts shown in the table below implements the formal logic grounding principles set forth in sub clause 24.2.

Note: The cells that are empty will be specified in a future revision of this specification.

Note: All SBVR Terms are “meanings” where all CL Terms are “representations of meanings.” Therefore there is a one-to-many relationship between SBVR Terms as meanings and CL Terms as representations of meanings; i.e., there can be multiple CL representations of one SBVR meaning.

SBVR Term	ISO CL Term (or equivalent expression)	OWL Term (or equivalent expression)	Comment
BASICS - Foundation			
<u>fact</u>	sentence with an interpretation 'taken to be' true NOTE: The mapping is many (sentences) to one (meaning)	OWL statement (<i>s, p, o</i>) interpreted as being true; individual	
<u>verb concept</u> (3+ary) + (characteristic)	unary predicate defining the type for a functional term or atomic sentence	---	
<u>verb concept</u> (binary verb concept)	unary predicate defining the type for a functional term or atomic sentence that has exactly two arguments	Class description defining RDF property or OWL object property (note: may only apply to OWL Full)	Need 2 RDF/OWL properties related by inverse of = one binary verb concept
<u>verb concept has verb concept role</u>	argument role in functional term or atomic sentence	---	
<u>verb concept has verb concept role</u> (binary verb concept)	argument role in functional term or atomic sentence that has exactly two arguments	the range of an rdf:Property or owl:ObjectProperty; alternatively, may be specified using a restriction on the property in OWL	
<u>verb concept role</u>	unary predicate defining the role of a name/term that is an argument	RDF/OWL subject or object	
<u>verb concept role ranges over general concept</u> (role ranges over general concept)	term over which argument ranges	value restriction on property	
<u>fundamental concept</u>			
<u>individual noun concept</u>	name	individual	
<u>general concept</u>	unary predicate	class	
<u>proposition</u>	sentence with an interpretation	OWL statement (<i>s, p, o</i>); individual	

<u>proposition is false</u>	sentence with an interpretation = false	OWL statement (<i>s, p, o</i>) interpreted as being false; individual	
<u>proposition is true</u>	sentence with an interpretation = true	OWL statement (<i>s, p, o</i>) interpreted as being true; individual	
<u>reference scheme</u>	approximately term		
<u>reference scheme extensionally uses role</u>			
<u>reference scheme is for concept</u>			
<u>reference scheme simply uses role</u>			
<u>reference scheme uses characteristic</u>			
<u>situational role</u>	unary predicate defining the role of a name/term that is an argument	RDF/OWL subject or object	
<u>situational role ranges over fundamental concept</u> (role ranges over general concept)	term over which argument ranges	value restriction on property	
BASICS - Extension in Model	<p>NOTE: There are two kinds of extensions in SBVR:</p> <ol style="list-style-type: none"> 1. Real things that never appear in an SBVR Model themselves 2. Model extensions: <ol style="list-style-type: none"> a. Individual noun concepts as model instances of general concepts (fundamental concepts only) b. facts as model instances of verb concepts 		
<u>concept₁ is coextensive with concept₂</u> (verb concept)	(forall (p1 p2) (if (and (binary verb concept p1) (binary verb concept p2)) (iff (is coextensive with p1 p2) (forall (x y) (iff (p1 x y) (p2 x y)))))))	owl:equivalentProperty	
<u>concept₁ is coextensive with concept₂</u> (noun concept)	(forall (c1 c2) (if (and (noun concept c1) (noun concept c2)) (iff (is coextensive with c1 c2) (forall (x) (iff (c1 x) (c2 x)))))))	owl:equivalentClass	
<u>concept has extension</u> (verb concept / verb concept)	"sentence type" has extension		

<u>concept has extension</u> (noun concept)	((forall (x)(iff (concept x) (or (= aaa-1 x) ... (= aaa-n x))))	enumeration of a class (OWL one Of)	
<u>extension</u>	extension	class	
<u>proposition corresponds to state of affairs</u>	approximately sentence denotation		
<u>concept has instance</u>	atom (concept thing)	can be specified via an rdf:type statement (<i>i.e.</i> , thing rdf:type concept.)	
<u>set</u>	set		
BASICS - Intension: Characteristic			
<u>characteristic</u>	(see characteristic)	(see characteristic)	(see characteristic)
<u>characteristic is essential to concept</u>			
<u>characteristic type</u>			
<u>concept has implied characteristic</u>			
<u>concept has necessary characteristic</u>			
<u>concept incorporates characteristic</u>	sentence (forall (u)(implies(characteristic u)(concept u)))	rdfs:subClassOf	
<u>delimiting characteristic</u>			
<u>essential characteristic</u>			
<u>implied characteristic</u>			
<u>intension</u>	intension		
<u>necessary characteristic</u>			
BASICS - Intension: Categorization			
<u>categorization scheme</u>			
<u>categorization type</u>			
<u>category</u>			
<u>concept type</u>	unary predicate	class	

<u>concept₁</u> <i>specializes</i> <u>concept₂</u> (binary verb concept)	(forall (p1 p2) (if (and (binary verb concept p1) (binary verb concept p2) (iff (specializes p1 p2) ((forall (x y) (if (p1 x y) (p2 x y))))))))))	rdfs:subPropertyOf + disjoint	
<u>concept₁</u> <i>specializes</i> <u>concept₂</u> (noun concept)	(forall (c1 c2) (if (specializes c1 c2) (forall (x) (if (c1 x) (c2 x)))))) (forall (c1 c2) (if (and (specializes c1 c2) (specializes c2 c3)) (specializes c1 c3)))	rdfs:subClassOf + disjoint	One way from SBVR to CL
<u>more general concept</u>			
<u>segmentation</u>			
BASICS - Modal Logic			
<u>element of guidance</u> <i>authorizes state of affairs</i>			
<u>element of guidance</u> <i>obligates state of affairs</i>			
<u>element of guidance</u> <i>prohibits state of affairs</i>			
<u>behavioral business rule</u>			
<u>proposition</u> <i>is necessarily true</i>			
<u>proposition</u> <i>is obligated to be true</i>			
<u>proposition</u> <i>is permitted to be true</i>			
<u>proposition</u> <i>is possibly true</i>			
<u>rule</u>			
<u>definitional rule</u>			
BASICS - Misc.			
<u>quantity₁</u> <i>is less than</i> <u>quantity₂</u>	functional term with operator "is less than" and arguments quantity1 and quantity2		

<u>integer</u>	atom (integer x)	xsd:integer	There are no explicitly defined types in CL; there is specific set of XML schema datatypes available for use with RDF and OWL
<u>nonnegative integer</u>	atom (nonnegative integer x)	xsd:nonNegativeInteger	
<u>number</u>	atom (number x)		
<u>positive integer</u>	atom (positive integer x)	xsd:positiveInteger	
<u>quantity</u>			
SEMANTIC FORMULATIONS			
<u>aggregation formulation</u>			
<u>antecedent</u>			
<u>at-least-n-quantification</u>		restriction, owl:minCardinality n	
<u>at-least-n-quantification</u> <i>has</i> <u>minimum cardinality</u>			
<u>at-most-n-quantification</u>		restriction, owl:maxCardinality n	
<u>at-most-n-quantification</u> <i>has</i> <u>maximum cardinality</u>			
<u>at-most-one-quantification</u>		restriction, owl:maxCardinality 1	
<u>atomic formulation</u>	atomic sentence or atom	if unary - rdf:type if binary - rdf;triple nothing not 3+	
<u>atomic formulation</u> <i>has</i> <u>role binding</u>			
<u>atomic formulation</u> <i>is based on</i> <u>verb concept</u>			
<u>auxiliary variable</u>			
<u>bag projection</u>			
<u>binary logical operation</u>			
<u>binary logical operation</u> <i>has</i> <u>logical operand 1</u>			
<u>binary logical operation</u> <i>has</i> <u>logical operand 2</u>			
<u>bindable target</u>			

<u>cardinality</u>		owl:cardinality	
<u>closed logical formulation</u>	sentence with an interpretation		
<u>closed logical formulation formalizes statement</u>			
<u>closed logical formulation means proposition</u>			
<u>closed projection</u>			
<u>closed projection defines verb concept</u>			
<u>closed projection defines noun concept</u>			
<u>closed projection means question</u>			
<u>closed semantic formulation</u>			
<u>conjunction</u>	conjunction with at least two conjuncts	owl:intersectionOf about the extension of a concept and not about the meaning of a sentence	
<u>consequent</u>			
<u>disjunction</u>	disjunction with at least two disjuncts	owl:unionOf *	
<u>equivalence</u>	biconditional	roughly owl:equivalentProperty	
<u>exactly-n quantification</u>		restriction, owl:cardinality n	
<u>exactly-n quantification has cardinality</u>			
<u>exactly-one quantification</u>		restriction, owl:cardinality 1	
<u>exclusive disjunction</u>	negation of biconditional	---	
<u>existential quantification</u>	quantified sentence of type existential	restriction, owl:someValuesFrom	
<u>implication</u>	implication	---	
<u>implication has antecedent</u>			

<u>implication has consequent</u>			
<u>inconsequent</u>			
<u>instantiation formulation</u>	atomic sentence or atom	rdf:type	
<u>instantiation formulation binds to bindable target</u>			
<u>instantiation formulation considers concept</u>			
<u>logical formulation</u>	sentence		
<u>logical formulation constrains projection</u>			
<u>logical formulation kind</u>			
<u>logical formulation restricts variable</u>		owl:Restriction - for specific kinds of restrictions (value, number)	
<u>logical negation</u>	negation	roughly owl:complementOf	
<u>logical operand</u>	argument of a functional term		
<u>logical operand 1</u>	argument of a functional term, first in sequence		
<u>logical operand 2</u>	argument of a functional term, second in sequence		
<u>logical operation</u>	term representing the operation for a functional term		
<u>logical operation has logical operand</u>			
<u>maximum cardinality</u>		owl:maxCardinality	
<u>minimum cardinality</u>		owl:minCardinality	
<u>modal formulation</u>	irregular sentence	---	
<u>modal formulation embeds logical formulation</u>			
<u>nand formulation</u>	negation of conjunction	---	
<u>necessity formulation</u>			
<u>nor formulation</u>	negation of disjunction	---	
<u>noun concept formulation</u>			

<u>numeric range quantification</u>		restriction, owl:minCardinality n AND restriction, owl:maxCardinality m	
<u>numeric range quantification</u> <i>has</i> <u>maximum cardinality</u>			
<u>numeric range quantification</u> <i>has</i> <u>minimum cardinality</u>			
<u>objectification</u>			
<u>objectification</u> <i>binds to</i> <u>bindable target</u>			
<u>objectification</u> <i>considers</i> <u>logical formulation</u>			
<u>obligation formulation</u>			
<u>permissibility formulation</u>			
<u>possibility formulation</u>			
<u>projecting formulation</u>			
<u>projecting formulation</u> <i>binds to</i> <u>bindable target</u>			
<u>projecting formulation</u> <i>has</i> <u>projection</u>			
<u>projection</u>			
<u>projection</u> <i>has</i> <u>auxiliary variable</u>			
<u>projection</u> <i>is on</i> <u>variable</u>			
<u>projection position</u>			
<u>quantification</u>	quantified sentence		
<u>quantification</u> <i>introduces</i> <u>variable</u>	approximately binding sequence for quantified sentence		
<u>quantification</u> <i>scopes over</i> <u>logical formulation</u>	body for quantified sentence		
<u>role binding</u>	binding sequence		
<u>role binding</u> <i>binds to</i> <u>bindable target</u>	binding		
<u>role</u> <i>has</i> <u>role binding</u>			

<u>scope formulation</u>			
<u>semantic formulation</u>			
<u>set <i>has</i> cardinality</u>			
<u>set projection</u>			
<u>universal quantification</u>	quantified sentence of type universal	restriction, owl:allValuesFrom	
<u>variable</u>	name/term	individual or blank node	
<u>variable <i>has</i> projection position</u>			
<u>variable <i>is free within</i> semantic formulation</u>			
<u>variable <i>is unitary</i></u>		approximately a functional property	
<u>variable <i>ranges over</i> concept</u>		---	
<u>whether-or-not formulation</u>	truth function operation	---	
<u>whether-or-not formulation <i>has</i> consequent</u>			
<u>whether-or-not formulation <i>has</i> inconsequent</u>			
SEMANTIC FORMULATION - Nominalization			
<u>answer nominalization</u>			
<u>verb concept nominalization</u>			
<u>proposition nominalization</u>			
<u>proposition nominalization <i>binds to</i> bindable target</u>			
<u>proposition nominalization <i>considers</i> logical formulation</u>			
<u>question nominalization</u>			

FACT MODELS			
<u>concept</u> <i>is closed in</i> <u>conceptual schema</u>			
<u>conceptual schema</u>			
<u>conceptual schema</u> <i>includes</i> <u>concept</u>			
<u>conceptual schema</u> <i>includes</i> <u>fact model</u>			
<u>fact model</u> <i>includes</i> <u>fact</u>			
<u>fact model</u> <i>is based on</i> <u>conceptual schema</u>			
<u>verb concept</u> <i>is internally closed in</i> <u>conceptual schema</u>			

25 Supporting Documents

25.1 General

Several XML documents are derived from this document, particularly for the following vocabularies specified in Clauses 7 through 21. Each of these has a namespace URI specified in Clause 7.

[SBVR Vocabulary](#)

The content of each of the documents listed in this clause is normative.

25.2 SBVR XMI Metamodel

The MOF-based metamodel package is shown in its XMI serialized form, with all merging of packages performed, as an XML document. The URL of each document is constructed by adding ”-XMI-Metamodel” in front of the “.xml” in the corresponding namespace URI. The document’s URL is listed here:

<https://www.omg.org/spec/SBVR/20190601/SBVR-XMI-Metamodel.xml>

25.3 SBVR XMI XML Schema

An XML Schema that is created based on the XMI 2.4.2 specification from each of the MOF-based metamodel packages listed in 25.2. SBVR tools generate and process SBVR Content Model exchange documents that validate according to the SBVR XML Schema file described here. The URL of each document is constructed by putting “.xsd” in place of “.xml” in the corresponding namespace URI. The schema’s URL is listed here:

<https://www.omg.org/spec/SBVR/20190601/SBVR-XML-Schema.xsd>

25.4 SBVR Content Model for SBVR

For the [SBVR Vocabulary](#) in clauses 7 through 21, all vocabulary entries and rules are described in terms of SBVR concepts, the SBVR XMI Metamodel (see 25.2) based on the rules in Clause 23 and Annex A. They are then serialized as XML documents based on the SBVR XMI XML Schema (see 25.3). This document is an XML serialization of the [SBVR Vocabulary](#) for discussing the semantics of business vocabulary and business rules. The document’s URL is listed here:

<https://www.omg.org/spec/SBVR/20190601/SBVR-Content-Model-for-SBVR.xml>

In each of the XML documents, an xmi:id used for a designation in a vocabulary namespace is constructed from the signifier of the designation by upcasing each character that follows a blank and then removing the blanks. Similarly, an xmi:id for a verb concept wording is constructed from the expression of the verb concept wording by removing subscripts, upcasing each character that follows a blank and then removing the blanks. This allows any of these designations and verb concept wordings described by one of the documents to be referenced using a URI which appends a “#” and an xmi:id to the document’s URL. For example, a URI for ‘noun concept’ is

<https://www.omg.org/spec/SBVR/20190601/SBVR-Content-Model-for-SBVR.xml#nounConcept>

Part IV - Annexes

This part contains the annexes, including:

A- SBVR Structured English

B- SBVR Structured English Patterns

C- Use of UML Notation in a Business Context to Represent SBVR-style Vocabularies

D- Additional References

Annex A - SBVR Structured English

(informative)

A.1 General

The most common means of expressing definitions and business rules is through statements, not diagrams. While diagrams are helpful for seeing how concepts are related, they are impractical as a primary means of defining vocabularies and expressing business rules.

This specification defines an English vocabulary for describing vocabularies and stating rules. There are many different ways that this vocabulary and other English vocabularies described using SBVR can be combined with common English words and structures to express definitions and statements. However expressed, the semantics of definitions and rules can be formally represented in terms of the SBVR vocabulary and, particularly, in terms of logical formulations (the SBVR conceptualization of formal logic).

This annex describes one such way of using English that maps mechanically to SBVR concepts. It is not meant to offer all of the variety of common English, but rather, it uses a small number of English structures and common words to provide a simple and straightforward mapping.

All formal definitions and rules in this document that are part of ‘SBVR in terms of itself’ are stated using the SBVR Structured English. These statements can then be interpreted automatically in order to create MOF and/or XMI representations.

Any character in the UTF-8 character set for the natural language used to write an SBVR terminological entry or element of guidance entry may be used in the text of that entry. This includes readability characters such as smart quotes.

The description of the SBVR Structured English is divided into sub clauses.

- Expressions in SBVR Structured English
- Describing a Vocabulary
- Vocabulary Entries
- Specifying a Rule Set
- Guidance Entries

A.2 Expressions in SBVR Structured English

This document contains numerous statements and definitions that represent corresponding logical formulations. These statements are recognized by being fully expressed using the fonts listed below. Note that these fonts are also used for individual designations in the context of ordinary, unformalized statements in order to note that defined concepts are being used.

There are four font styles with formal meaning:

- term The ‘term’ font is used for a designation for a noun concept (other than an individual noun concept), one that is part of a vocabulary being used or defined (e.g., modal formulation, verb concept). This style is applied to the designation where it is defined and wherever it is used.

Terms are usually defined using lower case letters unless they include a proper noun. Terms are defined in singular form. Plural forms are implicitly available for use.

Name

The ‘name’ font is used for a designation of an individual noun concept — a name. Names tend to be proper nouns (e.g., California). This style is applied to a name where it is defined and wherever it is used. Note that names of numerical values in formal statements are also shown in this style (e.g., 25). See the definition of ‘name’ for more details.

Names appear using appropriate capitalization, which is usually the first letter of each word, but not necessarily.

verb

The ‘verb’ font is used for designations for verb concepts — usually a verb, preposition, or combination thereof. Such a designation is defined in the context of a verb concept wording. This font is used both in the context of showing a verb concept wording (e.g.,

‘reference scheme is for concept’)

and in the context of using it in a statement (e.g.,

“Each reference scheme is for at least one concept.”)

See the definition of ‘verb concept wording’ in Part II for more details.

Verb concept wordings shown as vocabulary entries use singular, active forms of verbs with the exception that present participles are sometimes used for characteristics. Infinitive, subjunctive, passive, and plural forms of verbs are implicitly usable in statements and definitions. For a binary verb concept, the implicit passive form of a verb uses the past participle of the verb preceded by the word “is” and followed by the preposition “by.” For example, the implicit passive form of ‘expression represents meaning’ is ‘meaning is represented by expression’. The same pattern holds for verb concepts with more than two roles where a verb is used between the first two placeholders. For example, the implicit passive form of ‘thing fills role in actuality’ is ‘role is filled by thing in actuality’. Note that there is no inverse implication of an active form from a passive form.

A unary verb concept can have an implicit noun form that is usable in statements and definitions. For example, the implicit noun form of the verb concept ‘shipment is late’ is ‘late shipment’, meaning a shipment having the characteristic of being late.

keyword

The ‘keyword’ font is used for linguistic symbols used to construct statements – the words that can be combined with other designations to form statements and definitions (e.g., ‘each’ and ‘it is obligatory that’). Key words and phrases are listed below.

Quotation marks are also in the ‘keyword’ font. The text within quotes is in ordinary font if the meaning of the quotation is uninterpreted text. The text within quotes is in styled text if the meaning of the quotation is formally represented. Single quotation marks are used to quote a designation or verb concept wording that is being mentioned. If a designation is mentioned (where the designation is itself the subject of a statement) it appears within single quote marks (e.g., ‘actuality’ and ‘California’ used to talk about those designations). Single quotes are also used around a verb concept wording that is being mentioned (e.g., ‘reference scheme is for concept’ used to talk about that verb concept wording). Double quotation marks are used in other cases, such as to quote a statement.

Single quotation marks are also used to mention a concept – to refer to the concept itself rather than to the things it denotes. In this case, a quoted designation or verb concept wording is preceded by the word ‘concept’ or by a term for a kind of concept. For example, the statement,

“The concept ‘quantification’ is a category of the concept ‘logical formulation’”

refers to the named concepts, not to quantifications and logical formulations. A role can be named with respect to a verb concept in this same way (e.g.,

“the role ‘meaning’ of the verb concept ‘expression represents meaning’”).

Periods also appear in the ‘keyword’ font. A period is used to terminate a statement, but not a definition. Other punctuation symbols (e.g., parentheses, comma) also apply the ‘keyword’ font when part of a formal expression.

A.2.1 Key words and phrases for logical formulations

Key words and phrases are shown below for expressing each kind of logical formulation. The letters ‘ n ’ and ‘ m ’ represent use of a literal whole number. The letters ‘ p ’ and ‘ q ’ represent expressions of propositions.

A.2.1.1 Quantification

each	universal quantification
some	existential quantification
at least one	existential quantification
at least n	at-least-n quantification
at most one	at-most-one quantification
at most n	at-most-n quantification
exactly one	exactly-one quantification
exactly n	exactly-n quantification
at least n and at most m	numeric range quantification
more than one	at-least-n quantification with $n = 2$
no	logical negation whose logical operand is an existential quantification

A.2.1.2 Logical Operations

it is not the case that p	logical negation
p and q	conjunction
p or q	disjunction
p or q but not both	exclusive disjunction
if p then q	implication
q if p	implication
p if and only if q	equivalence (see exception explained under Modal Operations below)
not both p and q	nand formulation
neither p nor q	nor formulation
p whether or not q	whether-or-not formulation

Where a subject is repeated when using ‘and’ or ‘or’ the repeated subject can be elided. For example, the statement, “An implication has an antecedent and the implication is embedded in a modal formulation,” can be abbreviated to this: “An

implication has an antecedent **and** is embedded in a modal formulation.” Similarly, a repeated subject and verb can be elided. For example, the statement, “An implication has an antecedent **and** the implication has a consequent,” can be abbreviated to this: “An implication has an antecedent **and** a consequent.”

The keyword ‘**not**’ is used within an expression after the verb “*is*” as a way of introducing a [logical negation](#). Also, the keywords “**does not**” are used before other verbs (modified to be infinitive) to introduce a [logical negation](#).

A.2.1.3 Modal Operations

it is obligatory that p	obligation formulation
it is prohibited that p	obligation formulation embedding a logical negation
it is necessary that p	necessity formulation
it is impossible that p	necessity formulation embedding a logical negation
it is possible that p	possibility formulation
it is permitted that p	permissibility formulation

The following key words are used within expressions having a verb to form verb complexes that add a modal operation.

... must ...	obligation formulation
... must not ...	obligation formulation embedding a logical negation
... need not ...	the negation of obligation formulation (i.e., non-obligation)
... always ...	necessity formulation
... never ...	necessity formulation embedding a logical negation
... can ...	possibility formulation
... may ...	permissibility formulation

The key word phrase “**only if**” is used in combination with some of the key words and phrases shown above to invert a modality.

... may ... only if p	is equivalent to	... must not ... if not p
it is permitted that q only if p	is equivalent to	it is obligatory that not q if not p
it is possible that q only if p	is equivalent to	it is necessary that not q if not p

For example, the following two statements have the same meaning.

A car **may** be rented **only if** the car is available.

A car **must not** be rented **if** the car is **not** available.

The key word “**only**” can also be used before a preposition in combination with “**may**” to invert a modality. The noun phrase after the preposition is then understood as a negated restriction as shown in these two equivalent statements:

A car **may** be rented **only** to a licensed driver.

A car **must not** be rented to a person **that is not** a licensed driver.

Because of the use of “only” in stating modal operations, the pattern “*p* if and only if *q*” for [equivalence](#) is not used if *p* involves a modal operation.

A.2.2 Other Keywords

- the** 1. used with a designation to make a pronominal reference to a previous use of the same designation. This is formally a binding to a variable of a quantification.
2. introduction of a name of an individual thing or of a definite description
- a, an** universal or existential quantification, depending on context based on English rules
- another** (used with a term that has been previously used in the same statement) existential quantification plus a condition that the referent thing is not the same thing as the referent of the previous use of the term
- a given** universal quantification pushed outside of a logical formulation where ‘a given’ is used such that it represents one thing at a time – this is used to avoid ambiguity where the ‘a’ by itself could otherwise be interpreted as an existential quantification. Within a definition, ‘a given’ introduces an auxiliary variable into the closed projection that formalizes the definition.
- that** 1. when preceding a designation for a noun concept, this is a binding to a variable (as with ‘the’).
2. when after a designation for a noun concept and before a designation for a verb concept, this is used to introduce a restriction on things denoted by the previous designation based on facts about them.
3. when followed by a propositional statement, this is used to introduce a nominalization of the proposition or an objectification, depending on whether the expected result is a proposition or a state of affairs. See A.2.5.
- who** the same as the second use of ‘that’ but used for a person
- is of** The common preposition “of” is used as a shorthand for “that is of.” For any sentential form that takes the general form of ‘<placeholder 1> has <placeholder 2>’ there is an implicit reversed form of ‘<placeholder 2> is of <placeholder 1>’ that has the same meaning.
- what** used to introduce a variable in a projection as well as indicate that a projection is being formulated to be considered by a question or answer nominalization. See A.2.5 below.

A.2.3 Examples

The example above includes three key words or phrases, two designations for noun concepts and one for a verb concept (from a verb concept wording), as illustrated below.

It is obligatory that each rental car is owned by exactly one branch.

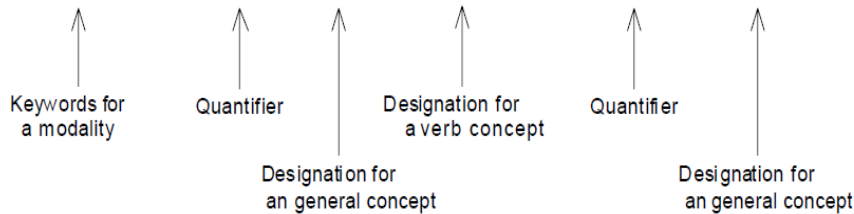

Below are two statements of a single rule:

1. A rental must have at most three additional drivers.
2. It is obligatory that each rental has at most three additional drivers.

Using the font styles of SBVR Structured English, these rule statements are:

1. A rental must *have* at most three additional drivers.
2. It is obligatory that each rental *has* at most three additional drivers.

A semantic formulation of the rule can be seen in the introduction to Clause 21.

The characteristic ‘driver is of age’ has the following definition: “the age of the driver is at least the EU-Rent Minimum Driving Age.” Below is the definition using the SBVR Structured English styles.

Definition: the age of the driver is at least the EU-Rent Minimum Driving Age

A semantic formulation of the definition can be seen in the introduction to Clause 21.

A.2.4 Qualifying Signifiers by Vocabulary and/or Subject Field

Some signifiers are used to mean different things in different vocabularies or in different contexts. In SBVR structured English a signifier can be followed by parentheses enclosing the name of a vocabulary and/or a subject field. If both are present, they are separated by a comma. Qualifications are shown in the example rules below.

Necessity: Each customer (car rental responsibility) is a corporate renter or is an individual customer.

The signifier “customer” is used in two ways in the EU-Rent English Vocabulary. So the first rule above uses “customer” for its meaning in the subject field ‘car rental responsibility’.

If the same rule is stated in a place where the EU-Rent English Vocabulary is not understood to be in use, the rule would be stated as follows in order to fully qualify its terms:

Necessity: Each customer (EU-Rent English Vocabulary, car rental responsibility) is a corporate renter (EU-Rent English Vocabulary) or is an individual customer (EU-Rent English Vocabulary).

A.2.5 Objectification and Nominalization

The keyword ‘**that**’ can introduce a propositional expression for either of two kinds of logical formulations: objectification and proposition nominalization. The following examples use the verb concepts ‘**car is assigned to rental**’, ‘**car assignment involves car**’, ‘**car assignment is to rental**’, ‘**rental has pick-up date**’, and ‘**rental is guaranteed by credit card**’.

The first example is a definitional rule statement whose logical formulation includes an objectification. It states that a **car assignment** is an actuality denoted by the proposition that a given car is assigned to a given rental. Note that only the third use of ‘**that**’ in the example below introduces an objectification. The others introduce restrictions

Necessity: **A car assignment that involves a car and that is to a rental is an actuality that the car is assigned to the rental.**

An objectification uses a propositional expression to identify a state of affairs or event. States and events can then be related to times and durations or be involved in any number of verb concepts that concern states or events. Consider the following examples of verb concepts.

state of affairs occurs before point in time

state of affairs₁ occurs before state of affairs₂ occurs

The following rule uses the first verb concept above:

A car assignment that is to a rental must occur before the pick-up date of the rental.

SBVR Structured English supports formulating an objectification using a convenient mechanism that is based on the word “**occurs**” being in the designation of a verb concept after a placeholder. An implicit form of the verb concept leaves out the word “**occurs**” after the placeholder and takes a propositional expression rather than a noun expression in the position of the placeholder. In other words, the rule above can be stated like this:

A car must be assigned to a rental before the pick-up date of the rental.

These implicit forms enable objectifying directly within a statement without separately defining a verb concept objectification for each verb concept whose instances might be objectified. For example, using the second verb concept listed above the following rule can be formed even though no general concept is defined to objectify the verb concept ‘**rental is guaranteed by credit card**’.

A rental must be guaranteed by a credit card before a car is assigned to the rental.

The next example is a proposition nominalization. It uses the additional verb concepts ‘**report specifies fact**’ and ‘**rental has rental report**’. The keyword ‘**that**’ nominalizes a fact to be specified.

If a car is assigned to a rental then the rental report of the rental must specify that the car is assigned to the rental.

The next example is an answer nominalization. The keyword ‘**what**’ is used to put variables in a projection.

The rental report of each rental must specify what car is assigned to the rental.

An expression of a statement can include the keyword ‘**what**’ multiple times, putting more variables in the projection (for example, “**what car is assigned to what rental**”). A question nominalization is formed in the same way as an answer nominalization, but nominalizes the question itself rather than an answer to it.

A.2.6 Intensional Roles

Some verb concepts about time and change have what can be called intensional roles. Each intensional role ranges over a concept type. In English, most verbs are about their expressed subjects and objects, but in some cases, a verb involves the meaning of the expression of the subject or object. The verb takes its argument by name rather than by value. Verb concepts for such verbs are often about time and change.

The SBVR Structured English uses a special syntactic clue to identify placeholders for intensional roles in verb concept wordings. A placeholder that ends with an asterisk is taken to indicate that a noun concept nominalization is used in the formulations of uses of the verb concept wording so that rather than binding to what is directly denoted by an expression, the role binds to the concept of what is expressed. The asterisk is part of the placeholder. An example of a logical formulation based on the first verb concept below is in the description of [noun concept nominalization](#) in Clause 21. Note that the examples below are not part of the normative SBVR vocabularies.

unitary noun concept* *changes*

- Definition: one thing replaces another thing as being the instance of [the unitary noun concept](#)
- Example: “The scheduled pick-up time of an advance rental can change”.
- Example: For every rental, the pick-up location of the rental cannot change.

unitary noun concept* *changes to thing*

- Definition: [the thing](#) replaces another thing as being the instance of [the unitary noun concept](#)
- Example: “The return branch of a rental changes to the Heathrow Airport branch”.

unitary quantity concept

- Definition: [unitary noun concept](#) [that](#) incorporates the characteristic of being a quantity

unitary quantity concept* *increases by quantity*

- Definition: a quantity equal to an initial quantity plus [the quantity](#) replaces the initial quantity as being the instance of [the unitary quantity concept](#)
- Example: “EU-Rent’s headcount increases by 300”.
- Suppose EU-Rent’s headcount has been 500. In the formulation of the statement, the ‘[unitary quantity concept*](#)’ role binds to a general concept defined as EU-Rent’s headcount. It does not bind to 500, which has been the instance of that general concept. The ‘[quantity](#)’ role binds to the quantity 300. The conclusion is that the quantity 800 replaces 500 as EU-Rent’s headcount. In contrast, suppose the statement were formulated using a different verb concept, ‘[quantity₁](#) increases by [quantity₂](#),’ which does not use an intensional role. The ‘[quantity₁](#)’ role would bind to 500 leading to the conclusion that 500 increases by 300, which is nonsense because 500 will always be 500.

A.3 Describing a Vocabulary

A vocabulary is described in a document sub clause having glossary-like entries for concepts having representations in the vocabulary. Those entries are explained in the next sub clause. The introduction to a vocabulary description includes the vocabulary’s name and can further include any of the several kinds of details shown in the skeleton below.

<Vocabulary Name>

Description:

Source:
Speech Community:
Language:
Included Vocabulary:
Note:

A.3.1 The Vocabulary Name

The vocabulary name appears in the ‘Name’ Font.

A.3.2 Description

The ‘Description’ caption is used to introduce the scope and purpose of the vocabulary.

A.3.3 Source

The ‘Source’ caption is used if the vocabulary being described is based on a formally-defined work. For example, if the vocabulary being described is based on a glossary or other document developed independently of the formalisms of SBVR, then that glossary or other document is shown as the source.

A.3.4 Speech Community

The ‘Speech Community’ caption is used to name the speech community that controls and is responsible for the vocabulary.

A.3.5 Language

The ‘Language’ caption is used to name the language that is the basis of the vocabulary. Language names are from [ISO 639-2 \(English\)](#). By default, [English](#) is assumed. Note that the SBVR Structured English is based only on English, so descriptions, definitions, and other details are in English but representations being defined can be in another language.

EU-Rent Vocabulaire Française

Language: French

A.3.6 Included Vocabulary

The ‘Included Vocabulary’ caption is used to indicate that another vocabulary is fully incorporated into the vocabulary being described. All designations and verb concept wordings of an included vocabulary are part of the vocabulary being described.

A.3.7 Note

The ‘Note’ caption labels explanatory notes that do not go under the other captions.

A.4 Vocabulary Entries

Each entry is for a single concept, called the entry concept. It starts with a primary representation which is either a designation or a verb concept wording for the concept.

Any of several kinds of captioned details can be listed under the primary representation. A skeleton of a vocabulary entry is shown below followed by an explanation of the use of each caption.

<primary representation>

Definition:
Source:
Dictionary Basis:
General Concept:
Concept Type:
Necessity:
Possibility:
Reference Scheme:
Note:
Example:
Synonym:
Synonymous Form:
See:
Subject Field:
Namespace URI:

A.4.1 Designation or Verb Concept Wording

A primary representation of an entry can be a term, a name, or a verb concept wording. It is shown in its appropriate font style. The primary representation for a general concept is a term that is a designation of the general concept. The primary representation for an individual noun concept is a name that is a designation of the individual noun concept.

The primary representation for a verb concept is a verb concept wording. The expression of a placeholder is generally the underlined signifier of a designation used by the placeholder to indicate that expressions substituted for the placeholder are understood to denote instances of the designated concept. A designation used by a placeholder for a verb concept role is a designation of a general concept that the verb concept role ranges over. That general concept can be a situational role. Sometimes the designation of the general concept has the same signifier as a designation of the verb concept role. In the unusual verb concept wording where multiple placeholders use the same designation, the expression of a placeholder can include a subscript to make the expressions of placeholders distinct within the verb concept wording. Subscripts also help to correlate placeholders across synonymous forms as shown in the example below.

concept₁ specializes concept₂

Definition: the concept₁ incorporates each characteristic incorporated into the concept₂ plus at least one differentiator

Synonymous Form: concept₂ generalizes concept₁

Synonymous Form: concept₁ has more general concept₂

Synonymous Form: concept₂ has category₁

The verb concept wordings in the example above represent one verb concept that has two verb concept roles. From the primary entry it is seen that each of the verb concept roles ranges over the concept 'concept'. From the second synonymous form, it is seen that the second verb concept role more specifically ranges over the general concept 'more general concept'

(which is a situational role). From the third synonymous form, it is seen that the first verb concept role more specifically ranges over the general concept ‘[category](#)’ (which is also a situational role).

Note: The primary representation for a verb concept is a verb concept wording rather than a designation because designations of verb concepts typically have nonunique signifiers (e.g., “has”).

The primary representation, whether a designation or verb concept wording, is in the vocabulary namespace for the vocabulary. Also, if a verb concept wording is of the pattern “<placeholder 1> has <placeholder 2>”, the expression of <placeholder 2>, less any subscript, is taken as the signifier of a designation of the second verb concept role. That designation is in an attributive namespace for the subject concept represented by the designation used for <placeholder 1>. Having a designation for the second verb concept role in an attributive namespace means that the designation is recognized as representing the role when it is used in the context of being attributed to instances of the subject concept. From the example above two designations of verb concept roles are found in an attributive namespace having the subject concept ‘[concept](#)’. These designations have the signifiers “more general concept” and “category.” Although these designations have the same signifiers as designations of the general concepts ‘[more general concept](#)’ and ‘[category](#)’, they are different designations. They are within the attributive namespace and represent different concepts (the verb concept roles, not the general concepts). See examples in sub clause 19.5.3 under ‘[attributive namespace](#)’. Also, if a verb concept wording is for a unary characteristic, a designation is in an attributive namespace for the concept represented by the designation used for the verb concept wording’s placeholder.

It is recommended that quantifiers (including articles) and logical operators not be embedded within designations and verb concept wordings.

A.4.2 Definition

A definition is shown as an expression that can be logically substituted for the primary representation. It is not a sentence, so it does not end in a period.

A definition can be fully formal, partly formal or informal. It is fully formal if all of it is styled as described above. A partially-formal definition starts with a styled designation for a more general concept but other details depend on external concepts.

Styles of definition are explained separately for different types of concepts.

A.4.2.1 Definition of a General Concept

A common pattern of definition begins with a designation for a more general concept followed by the keyword ‘[that](#)’ (used in the second sense defined for ‘[that](#)’ in the Other Keywords sub clause above) and then an expression of necessary and sufficient characteristics that distinguish a thing of the defined concept from other things of the more general concept. Another less used pattern also leads with a designation for a more general concept but then uses the word ‘[of](#)’ with another expression as explained in the Other Keywords sub clause above.

Two kinds of information are formally expressed by a fully formal definition.

1. A fact that the concept being defined is a category of a particular more general concept
2. A closed projection that defines the concept.

Only the first kind of information is formally expressed by a partially formal definition. A partially formal definition leads with a styled designation that is for a more general concept. That designation is generally followed by the keyword ‘[that](#)’ and then an informal expression of necessary and sufficient characteristics.

The following example shows a partially formal definition. It formally expresses the fact that the concept ‘[icon](#)’ is a category of the concept ‘[nonverbal designation](#)’, but it uses words that are external to the formally available vocabulary.

icon

Definition: [nonverbal designation](#) **that** is a pictorial representation

The next example is fully formal. Its formal interpretation includes that the concept ‘[representation](#)’ specializes the concept ‘[actuality](#)’ and includes a closed projection conveying semantics of the definition.

representation

Definition: [actuality](#) **that a given** [expression](#) **represents a given** [meaning](#)

The next example is not formal at all. It defines the most general concept used by SBVR.

thing

Definition: anything perceivable or conceivable

A definition of a general concept can generally be read as a statement using the following pattern (where “a” represents either “a” or “an”):

A <designation> is a <definition>.

For example: An icon is a nonverbal designation that is a pictorial representation.

Another style of formal definition is extensional. It uses disjunction to combine a number of concepts. For example, a contextualized concept is anything that is a role or a facet.

contextualized concept

Definition: [role](#) **or** [facet](#)

A semantic formulation of the extensional definition above is the same as for the logically equivalent definition, “[thing that is a role](#) **or that is a facet**.”

A.4.2.2 Definition of an Individual Noun Concept

A definition of an individual noun concept must be a definite description of one single thing. It can start with a definite article (e.g., “[the](#)”). It can generally be read as a statement using the following pattern. The leading “The” is optionally used depending on the designation.

[The] <designation> is <definition>.

It is often the case that an individual noun concept has no definition because it is widely understood. In such a case the ‘General Concept’ caption can be used to state the type of the named thing. Here is an example.

Switzerland

General Concept: [country](#)

A.4.2.3 Definition of a Verb Concept

A definition given for a verb concept is an expression that can be substituted for a simple statement expressed using a verb concept wording of the verb concept.

The definition must refer to the placeholders in the verb concept wording. This is done in order to relate the definition to the things that play a role in instances of the verb concept. Whether or not the definition is formal, each reference to a placeholder appears in the ‘term’ font and is preceded by the definite article, “the”.

Here is an informal example followed by a fully-formal one.

statement expresses proposition

Definition: **the proposition** is what is meant by **the statement**

sequence is of general concept

Definition: **each thing that is included in the sequence is an instance of the general concept**

The second definition above is formal such that it translates to a closed projection.

A definition of a verb concept can generally be read using the pattern below, which is shown for a binary verb concept but works for verb concepts of any arity (“a” represents either “a” or “an”).

A fact that a given <placeholder 1> <verb concept designation> a given <placeholder 2> is a fact that <definition>.

For example: A fact that a given statement expresses a given proposition is a fact that the proposition is what is meant by the statement.

Similarly, the equivalence understood from a definition of a verb concept can generally be read using the following pattern:

A <placeholder 1> <verb concept designation> a <placeholder 2> if and only if <definition>.

For example: A statement expresses a proposition if and only if the proposition is what is meant by the statement.

A.4.3 Source

The ‘Source’ caption is used to indicate a source vocabulary or document for a concept.

The source’s designation for the concept is given in square brackets and quoted after the name of the source. It might or might not match the entry’s primary representation. If the source has a name for the concept itself, the name is given in square brackets unquoted. The designation from the source is quoted if it is a term for the concept.

thing

Source: ISO 1087-1 (English) (3.1.1) [‘object’]

individual noun concept

Source: ISO 1087-1 (English) (3.2.2) [‘individual noun concept’]

The keywords “**based on**” indicate the definition of the concept is largely derived from the given source but had some modification, as in the following example.

language

Definition: system of arbitrary signals (such as voice sounds or written symbols) and rules for combining them as used by a nation, people or other distinct community

Source: [based on AH](#)

A.4.4 Dictionary Basis

This caption labels a definition from a common dictionary that supports the use of the primary representation. The entry source reference (written in the ‘Source’ style described above) is supplied at the end of the quoted definition. A dictionary basis should not be interpreted as an adopted definition.

A.4.5 General Concept

The ‘General Concept’ caption can be used to indicate a concept that generalizes the entry concept. This is not needed if there is a definition that starts with the general concept, but it is helpful in cases where a definition is not provided, such as is often the case for individual noun concepts (named things) or concepts taken from a source. Here are two examples.

Switzerland

General Concept: [country](#)

individual noun concept

Source: [ISO 1087-1 \(English\)](#) (3.2.2) [‘individual noun concept’]

General Concept: [concept](#)

A.4.6 Concept Type

The ‘Concept Type’ caption is used to specify a type of the entry concept. This is typically not used if the concept has no particular type other than what is obvious from the primary representation.

- A name is implicitly for an [individual noun concept](#).
- Any term is implicitly for a [general concept](#).
- A verb concept wording is implicitly for a [verb concept](#).
- For a verb concept wording, one placeholder implies a [characteristic](#) and two placeholders imply a [binary verb concept](#). For example, ‘[variable has type](#)’ is implicitly for a [binary verb concept](#).
- Where a definition formally gives a more general concept, the concept being defined specializes that more general concept.

If more than one concept type is mentioned, then they are separated by commas. Order is insignificant.

The concept type ‘[role](#)’ is commonly used where the primary entry is a term. The example below shows that the concept ‘[logical operand](#)’ is a role that is played by a logical formulation. Since the entry concept of a term is implicitly a [general concept](#), the additional indication that it is a [role](#) implies that it is, by definition, a [situational role](#).

logical operand

Concept Type: [role](#)

Definition: [logical formulation](#) upon which [a given logical operation](#) operates

Any [general concept](#) that specializes the concept ‘[concept](#)’ can be given as a concept type. The concept ‘[obligation formulation](#)’ is a logical formulation kind, which is defined below.

logical formulation kind

Definition: [concept that specializes the concept 'logical formulation' and that](#) classifies a [logical formulation](#) based on the presence or absence of a main logical operation or quantification

obligation formulation

Concept Type: [logical formulation kind](#)

A.4.7 Necessity and Possibility

A definitional rule or advice of possibility is usually supplemental to some definition(s). Either a "Necessity:" caption or a "Definitional Rule:" caption is used to state that something is necessarily true. A "Possibility:" caption or a "Possibility Advice:" caption explains that something is a possibility that is not prevented by some definition(s). See the vocabulary entries in Clauses 8 through 21 for 'definitional business rule statement' and 'unrestricted business rule possibility statement' (respectively) for more details.

The content that follows both the "Necessity:" / "Definitional Rule:" caption and the "Possibility:" / "Possibility Advice:" caption is the proposition that is asserted to be a definitional rule or advice of possibility respectively without any additional wording to indicate the modality of the element of guidance, as this is implied by the respective captions. Here are examples - two definitional rules and one advice of possibility.

representation

Necessity: Each [representation](#) *has* exactly one [expression](#).

Necessity: Each [representation](#) *represents* exactly one [meaning](#).

vocabulary namespace maps to package

Possibility: A [vocabulary namespace](#) *maps to* more than one [package](#).

Definitions express characteristics that are necessary and sufficient to distinguish things denoted by a concept. Sometimes there are necessities beyond what is sufficient. The 'Necessity' caption is used to state such necessities.

A.4.8 Reference Scheme

The 'Reference Scheme' caption is used to state how things denoted by the term can be distinguished from each other based on one or more facts about the things. A reference scheme is expressed by referring to at least one role of a binary verb concept and indicating whether a reference involves a single instance of the role or whether it involves the extension of related instances.

An article ('a', 'an', or 'the') indicates a simple use of a role in which a single instance is used in a reference. The definite article 'the' is only appropriate where there can be at most one instance of the role. The words 'the set of' indicate that the extension is used. The word 'and' is used to connect the expressions of use of multiple roles by a reference scheme.

The following examples of reference schemes are taken from the SBVR Vocabularies. The first one below uses a single value of the '[closed logical formulation](#)' role of the verb concept '[closed logical formulation means proposition](#)' meaning that a proposition can be identified by any closed logical formulation whose meaning is the proposition. The second uses two verb concept roles. It uses a definite article because each [role binding](#) has exactly one [bindable target](#) and is for exactly one [verb concept role](#).

proposition

Reference Scheme: a [closed logical formulation](#) *that means the* [proposition](#)

role binding

Reference Scheme: the bindable target that *is referenced by* the role binding and the verb concept role that *has* the role binding

The reference scheme for the concept of reference scheme itself uses three roles extensionally.

reference scheme

Reference Scheme: the set of verb concept roles that *are simply used by* the reference scheme and the set of verb concept roles that *are extensionally used by* the reference scheme and the set of characteristics that *are used by* the reference scheme

A.4.9 Note

A ‘Note’ caption is used to label explanatory notes that do not fit within the other captions.

A.4.10 Example

The ‘Example’ caption labels examples involving the entry concept.

A.4.11 Synonym

A synonym is another designation that can be substituted for the primary representation. It is a designation for the same concept. If the primary representation is a verb concept wording, then the ‘Synonymous Form’ caption is used rather than the ‘Synonym’ caption.

The examples below show two synonyms for one concept having one definition. The preferred designation is given as the primary representation.

implication

Definition: logical formulation that applies the logical “(MATERIALLY) IMPLIES” operation (\rightarrow) to an antecedent and a consequent

Synonym: material implication

The meaning of two designations being synonyms is that they represent the same concept. Each synonym is in the vocabulary namespace of the vocabulary.

A.4.12 Synonymous Form

A synonymous form is a verb concept wording for the same verb concept. The order of placeholders for verb concept roles can be different.

A synonymous form can appear elsewhere as its own entry. However, this is not typically done if the synonymous form is simply a passive form of the primary representation. The following example shows a synonymous form that reverses the order of verb concept roles. Because the synonymous form is simply a passive form of the primary representation, it does not appear as a separate entry.

statement expresses proposition

Definition: the proposition is what is meant by the statement

Synonymous Form: proposition *is expressed by* statement

A synonymous form does not necessarily use the same designations for all placeholders as are used in the primary designation. One placeholder can use a different designation. The ones using the same designation as placeholders of the primary form represent the corresponding verb concept roles, and the one placeholder that does not match represents the remaining verb concept role. The example below shows two entries, both for the same concept. One is expressed in terms of a role ([instance](#)) and the other is not.

concept corresponds to thing

Definition: [the thing](#) is in the extension of [the concept](#)

Synonymous Form: [concept has instance](#)

concept has instance

Synonymous Form: [concept corresponds to thing](#)

If the same term is used for multiple placeholders, then subscripts can be used to distinguish them.

thing₁ is thing₂

Synonymous Form: [thing₁ equals thing₂](#)

The meaning of two verb concept wordings being synonymous is that the two represent the same verb concept. Each synonymous form is in the vocabulary namespace of the vocabulary. Designations are in attributive namespaces as explained for primary entries in A.4.1.

A.4.13 See

Where the primary representation is not a preferred representation for the entry concept, the “See:” caption introduces the preferred representation. No definition is given in this case.

A.4.14 Subject Field

Where a signifier is not unique in a vocabulary, there is a need for qualification by a subject field. The subject field of a designation is given using the “Subject Field” caption, as shown in the example below.

customer

Subject Field: [Car Rental Responsibility](#)

See: [renter](#)

customer

Subject Field: [Vehicle Sales](#)

Definition: [person](#) who purchases a [rental car](#) from EU-Rent at the end of its rental life

A.4.15 Namespace URI

If the primary entry is for a namespace, the ‘Namespace URI’ caption is used to indicate a URI of the namespace. If the primary entry is for a vocabulary, the ‘Namespace URI’ caption is used to indicate a URI of a vocabulary namespace for the vocabulary. Here is an example:

Meaning and Representation Vocabulary

General Concept: [vocabulary](#)

Namespace URI: <http://www.omg.org/spec/SBVR/20070901/MeaningAndRepresentation>

A.5 Specifying a Rule Set

SBVR Structured English uses the term ‘rule set’ to refer to any set of elements of guidance. A rule set is specified in a document sub clause having several individual entries for guidance. Those entries are explained in the next sub clause. The introduction to a rule set includes the rule set’s name and can further include any of the several kinds of details shown in the skeleton below.

<Rule set name>

Description:

Vocabulary:

Note:

Source:

A.5.1 The Rule Set Name

The rule set name appears in the ‘name’ font.

A.5.2 Description

The ‘Description’ caption is used to describe the scope and purpose of the rules.

A.5.3 Vocabulary

The ‘Vocabulary’ caption is used to identify what vocabulary (defined in terms of SBVR) is used by statements in the rule set.

A.5.4 Source

The ‘Source’ caption is used if the rule set is based on a separately-defined work. It labels a reference to such a work, such as a legal statute.

A.5.5 Note

The ‘Note’ caption is used to label explanatory notes that do not fit within the other captions.

A.6 Guidance Entries

Each entry in a rule set is an element of guidance -- expressed as one of the following:

- A behavioral business rule statement
- A definitional business rule statement
- A statement of advice of permission
- A statement of advice of possibility

Business rules include only those rules under business jurisdiction. Entries can also be made for definitional rules that are not under business jurisdiction. Each entry includes the statement itself and optionally includes other information labeled by the captions shown below.

<Guidance Statement>

Name:

Guidance Type:

Description:

Source:

Synonymous Statement:

Note:

Example:

Enforcement Level:

Use of each of the above captions is explained below.

A.6.1 Guidance Statement

A guidance statement can be expressed formally or informally. A statement that is formal uses only formally styled text — all necessary vocabulary is available (by definition or adoption) such that no external concepts are required. Such a statement can be formulated as a logical formulation.

A.6.2 Name

The ‘Name’ caption is used to specify a name for the element of guidance. The name is then part of the formal vocabulary.

A.6.3 Guidance Type

The ‘Guidance Type’ caption is used to indicate the kind of element of guidance (i.e., one of the following):

- behavioral business rule
- definitional business rule
- advice of permission
- advice of possibility
- advice of optionality
- advice of contingency

A.6.4 Description

The ‘Description’ caption is used to capture the expression of the element of guidance informally (as supplied by a business user).

A.6.5 Source

The ‘Source’ caption is used if the guidance is from a separate source. It labels a reference to that source.

A.6.6 Synonymous Statement

The ‘Synonymous Statement’ caption is used to state additional, equivalent statements of the guidance. For example, a given rule can be expressed in a ‘prohibitive’ form and also in an ‘obligatory’ form. As for the primary statement of the guidance, these additional statements can be formal or informal.

A.6.7 Note

The ‘Note’ caption is used to label explanatory notes that do not fit within the other captions.

A.6.8 Example

The ‘Example’ caption labels examples of application of the element of guidance.

A.6.9 Enforcement Level

The ‘Enforcement Level’ caption labels the enforcement level that applies to a behavioral business rule (only).

Annex B - SBVR Structured English Patterns

(informative)

B.1 General

This annex contains material compiled to aid the interpretation of 'SBVR in SBVR Structured English' vocabulary entries, as documented in Annex A and applied in the text and diagram forms of Part II of this document.

This 'language patterns' material falls into three main sub clauses:

- Reading SBVR Vocabulary Designations
- Reading Embedded connections
- Defining a Verb Concept for Convenience

The third sub clause contains a brief discussion of a useful pattern that, while not often applied in the text of Part II, is illustrated in the EU-Rent Example (Annex G).

When there is an associated way to depict the construct using a graphic convention, a cross-reference is provided, when applicable, to the 'Conventions for Representing an SBVR-Style Vocabulary as a Concept Model Diagram' (Annex C) - referred to here as the 'CMD style' - and to the 'Concept Diagram Graphic Notation (Annex I)' - referred to here as the CDG style'.

B.2 Reading SBVR Vocabulary Designations

This sub clause presents the interpretation given to three kinds of designations:

- Terms
- Names
- Verb symbols

B.2.1 Primary Term for a General Concept

When I see a vocabulary entry as shown in Figure B.1, I know to vocalize it as:

'community' is a term for a general concept. And it is the 'primary' term used for the concept.

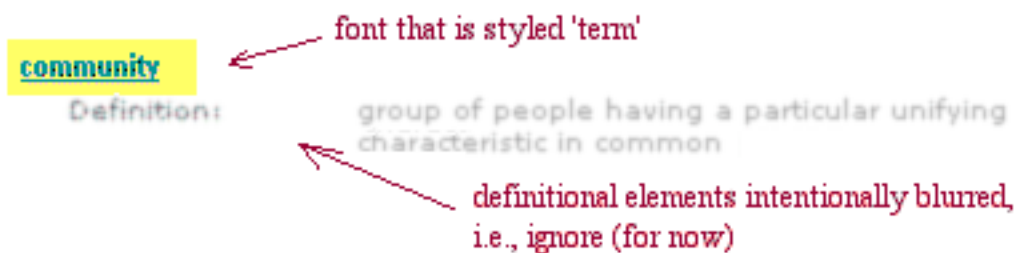

Figure B.1 - Recognizing an entry that is the primary term for a general concept

Commentary:

This is a typical kind of vocabulary entry for a designation of the primary term for a general concept. For how to depict this on a concept model diagram, see sub clause C.2 General Concept (Noun Concept) (for the CMD style) and sub clause I.2 Boxes - Concepts (for the CDG style).

It is possible to have additional terms for a given general concept (i.e., terms that are synonyms). When a synonym is provided for a vocabulary entry, the 'Synonym' caption is used. Additionally, when it is considered useful to make an explicit vocabulary entry for a non-primary term, that entry will appear using the 'See' caption as a referback to the concept's primary term.

Even when documented in the vocabulary, the non-primary terms of a concept are not typically reflected on a concept model diagram. For how to depict a synonym on a concept model diagram when this is considered useful, see sub clause C.2 General Noun Concepts (for the CMD style). There is no specified way to depict this in the CDG style.

B.2.2 Primary Name for an Individual Noun Concept

When I see a vocabulary entry as shown in Figure B.2, I know to vocalize it as:

'Real-world numerical correspondence' is a term that is a name for an individual noun concept. And it is the primary name used for the concept.

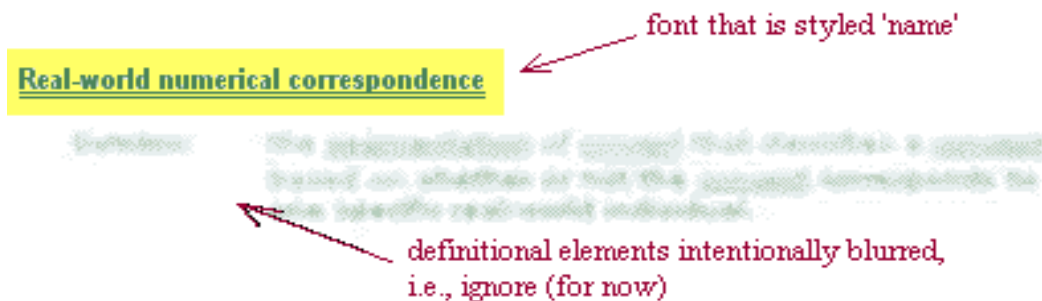

Figure B.2 - Recognizing an entry that is the primary name for an individual noun concept

Commentary:

This is a typical kind of vocabulary entry for a designation of the primary name for an individual concept. For how to depict this on a concept model diagram, see sub clause C.3 Individual Noun Concepts (for the CMD style). There is no specified way to depict this in the CDG style.

It is possible to have additional names for a given individual concept (i.e., names that are synonyms). When a synonym is provided for a vocabulary entry, the 'Synonym' caption is used. Additionally, when it is considered useful to make an explicit vocabulary entry for a non-primary name, that entry will appear using the 'See' caption as a referback to the concept's primary name.

Even when documented in the vocabulary, the non-primary names of a concept are not typically reflected on a concept model diagram.

B.2.3 Preferred Verb Concept Wording for a Verb Concept

B.2.3.1 Preferred Verb Concept Wording for a Verb Concept -- Binary Verb Concept

When I see a vocabulary entry as shown in Figure B.3, I know to vocalize it as:

There is a verb concept relating these two concepts and it uses the designation 'shares understanding of' when the concept terms are in this order. Optionally, alternative readings can be provided using the 'Synonymous Form' caption (as illustrated at the bottom of Figure B.3).

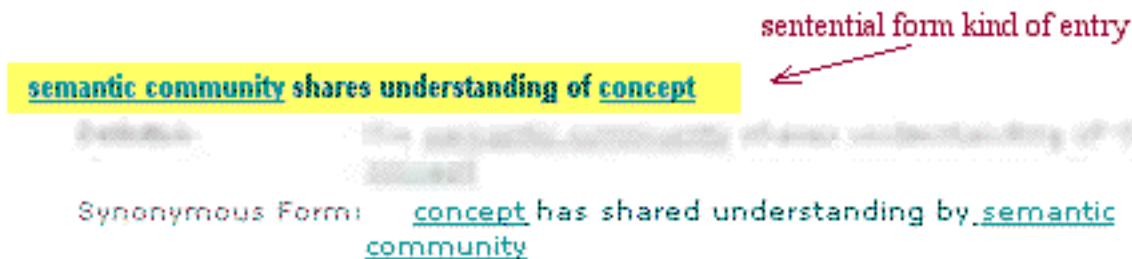

Figure B.3- Recognizing an entry that is the primary reading for a binary verb concept

Commentary:

This is a typical kind of vocabulary entry for a binary verb concept. For how to depict this on a concept model diagram, see sub clause C.4.1 Binary Verb Concepts (for the CMD style) and sub clause I.4.1 Binary Verb Concepts (for the CDG style). Additionally, the CMD style has a presentation convention for binary verb concepts that use 'has', as described in sub clause C.4.2 Binary Verb Concepts using 'has'.

It is possible to have additional wordings for a given binary verb concept (i.e., wordings that are synonymous forms). Depicting additional wordings is optional in both the graphic and text forms. When provided for a vocabulary entry, the 'Synonymous Form' caption is used.

Even when provided in as a vocabulary entry, more than one wording is not typically reflected on a concept model diagram. For how to depict a synonymous form wording on a concept model diagram when this is considered useful, see sub clause C.4.1 Binary Verb Concepts (for the CMD style). Additional wordings are specifically omitted in the CDG style (see I.4.1 Binary Verb Concepts).

B.2.3.2 Preferred Verb Concept Wording for a Verb Concept -- N-ary Verb Concept

When I see a vocabulary entry as shown in Figure B.4, I know to vocalize it as:

There is a ternary verb concept relating these three concepts, using 'is replaced by ... in' when the verb concept uses these terms for the concepts in this sequence.

rental car is replaced by replacement car in breakdown during rental

Definition: the substitution of a given rental car with a replacement car in a breakdown during rental.

Figure B.4 - Recognizing an entry that is the primary reading for an n-ary verb concept

Commentary:

This is a typical kind of vocabulary entry for an n-ary verb concept. For how to depict this on a concept model diagram, see sub clause C.4.3 Verb Concepts with Arity of 3 or more (for the CMD style) and sub clause I.4.2 N-ary Verb Concepts (for the CDG style).

B.2.3.3 Preferred Verb Concept Wording for a Verb Concept -- Characteristic

When I see a vocabulary entry as shown in Figure B.5, I know to vocalize it as:

There is a characteristic for this concept, with a designation of 'is damaged'.

rental car is damaged

Definition: a given rental car is damaged.

Figure B.5 - Recognizing an entry that is the primary reading for a characteristic

Commentary:

This is a typical kind of vocabulary entry for a unary verb concept. For how to depict this on a concept model diagram, see sub clause C.4.4 Unary Verb Concepts (for the CMD style) and sub clause I.4.3 Characteristics (for the CDG style).

B.2.3.4 Two Vocabulary Entries (Verb Concept Wording and Term) for One Concept

When I see a pair of vocabulary entries as shown in , I know to vocalize this case as:

These two entries are for coextensive concepts. I understand that, even though these are two entries in the vocabulary, they have the same instances.

Figure B.6- Recognizing a pair of entries (verb concept wording and term) for one concept

rented car is recovered from non-EU-Rent site to branch

car recovery

Definition: actuality that a given rented car is recovered from a given non-EU-Rent site to a given branch

For how to depict this on a concept model diagram, see sub clause C.9 Verb Concept Objectification (for the CMD style) and sub clause I.4.4 Very Concept Objectification (for the CDG style).

B.3 Reading Embedded Connections

There are also connections that are specified when the SBVR Structured English language is used to compose the definition of a vocabulary entry. The material in this sub clause documents the most common patterns used in writing vocabulary entry definitions using the elements of style defined in Annex C.

The following seven patterns have been documented.

- categorization
- is-role-of proposition
- is-facet-of proposition
- partitive verb concept
- classification (‘predefined extension’)
- categorization type
- categorization scheme

B.3.1 Categorization

When I see this:

semantic community

Definition: community whose unifying characteristic is a shared understanding (perception) of the things that they have to deal with

I know this is shorthand for:

semantic community

Concept Type: category

Definition: community whose unifying characteristic is a shared understanding (perception) of the things that they have to deal with

I know to vocalize it as:

The concept ‘semantic community’ is a ‘category’ of the more general concept ‘community’. Furthermore, I know that what distinguishes this particular kind of community from the general case is that it is ... <distinctions brought out in the rest of the definition>

For how to depict this on a concept model diagram, see sub clause C.6 Generalization/Specification (for the CMD style) and sub clause I.3.1 Simplet Categories (for the CDG style).

B.3.2 Is-role-of Proposition

When I see this:

renter

Concept Type: [role](#)
Definition: [driver](#) who ...

I know to vocalize it as:

The concept 'renter' is a role that can be played by a driver, specifically one who ...
<distinctions brought out in the rest of the definition>

For how to depict this on a concept model diagram, see sub clause C.5 Roles (for the CMD style) and sub clause I.5 Roles (for the CDG style). The CDG style does not distinguish the various ways to depict roles as in the CMD style (see the details in sub clauses C.5.1, C.5.2, and C.5.3).

B.3.3 Is-facet-of Proposition

When I see this:

driver

Concept Type: [facet](#)
Definition: [person](#) who ...

I know to vocalize it as:

The concept 'driver' is a facet (or aspect) of person, specifically just those characteristics of 'person' relevant to ... <distinctions brought out in the rest of the definition>

There is no specified way to depict this in either the CMD style or the CDG style.

B.3.4 Partitive Verb Concept

When I see this:

body of shared meanings₁ **contains** body of shared meanings₂

Concept Type: [partitive verb concept](#)
Definition: **the** [body of shared meanings](#) **includes** everything in **another** [body of shared meanings](#)

body of shared meanings **includes** body of shared concepts

Concept Type: [partitive verb concept](#)

I know to vocalize it as:

A body of shared meanings contains other bodies of shared meanings.

A body of shared meanings includes bodies of shared concepts.

For how to depict this on a concept model diagram, see sub clause C.8 Partitive Verb Concept (for the CMD style). There is no specified way to depict this in the CDG style.

vocabulary₁ **incorporates** vocabulary₂

Concept Type: [partitive verb concept](#)

Definition: the vocabulary₁ *includes* each symbol that *is included in* the vocabulary₂

Note: When more than one vocabulary is included, a hierarchy of inclusion can provide priority for selection of definitions.

vocabulary₂ *is incorporated into* vocabulary₁

vocabulary includes symbol

Concept Type: partitive verb concept

symbol *is included in* vocabulary

I know to vocalize it as:

A vocabulary incorporates (another) vocabulary.

A vocabulary includes symbols.

For how to depict this on a concept model diagram, see sub clause C.8 Partitive Verb Concept (for the CMD style). There is no specified way to depict this in the CDG style.

B.3.5 Classification ('Predefined Extension')

When I see this:

Canada

General Concept: country

I know to vocalize it as:

Canada is an instance of the concept 'country'

(or, 'Canada' is a designation of an individual country)

For how to depict this in graphics, see the discussion of 'Primary Name for an Individual Noun Concept' above.

Typically, this kind of entry is simply 'indicated' (or perhaps 'adopted'), with no definition. However, when a definition is written, its styling can specify the general concept, in which case, the 'General Concept' caption can be omitted. For example, the entry below defines 'Car Rental Industry' to be an instance of 'semantic community'.

Car Rental Industry

Definition: the semantic community that *is* the group of people who work in the business of renting cars

Commentary:

This is not typically depicted on a concept model diagram, but when it is, see sub clause C.3 Individual Noun Concepts (for the CMD style). There is no specified way to depict this in the CDG style.

B.3.6 Categorization Type

When I see this:

branch type

Definition: [concept that specializes the concept 'branch'](#) and that [classifies a branch](#) based on its [hours of operation](#) and [car storage capacity](#)

city branch

Concept Type: [branch type](#)

Definition: [branch](#) that operates in a city

I know to vocalize it as:

The concept 'branch type' has instances that are certain categories of the concept 'branch.'

The concept 'city branch' is a category of the concept 'branch.'

The concept 'city branch' is a 'branch type.'

Commentary:

When you find this pattern -- a 'Definition' caption that begins,

[concept that specializes the concept 'other-concept'](#) and that [classifies an other-concept](#) based on...

-- it is a compact, textual way to say multiple things, as follows:

1. that the mentioned *other-concept* has categories for which the *other-concept* is the more general concept, and
2. that the entry being defined is itself a category of concept, one whose instances are the categories of the mentioned more general concept.

Furthermore, the vocabulary entries for the certain category include a 'Concept Type:' caption that mentions the categorization type. For example, the vocabulary entry for 'city branch' mentions 'branch type' as its Concept Type.

For how to depict this on a concept model diagram, see sub clause C.7.2 Categories and Categorization Types (Concept Types) (for the CMD style). There is no specified way to depict this in the CDG style.

For how to depict this on a concept model diagram, see sub clause C.7.1 Categorization Schemes and Categories (for the CMD style) and sub clause I.3.2 Categorization Schemes and Segmentations (for the CDG style).

B.3.7 Categorization Scheme

When I see this:

Branches by Type

Description: [segmentation that is for branch and subdivides branch](#) based on [branch type](#)

Necessity: [Branches by Type contains the categories 'airport branch' and 'city branch' and 'agency'.](#)

agency

Definition: [branch that does not have a EU-Rent location and has minimal car storage and has on-demand operation](#)

Necessity: [agency is included in Branches by Type.](#)

airport branch

Definition: [branch that has a EU-Rent location and has large car storage and has 24-7 operation](#)

Necessity: [airport branch is included in Branches by Type](#).

city branch

Definition: [branch that has a EU-Rent location and has moderate car storage and has long business hours](#)

Necessity: [city branch is included in Branches by Type](#).

I know to vocalize it as:

'Branches by Type' is the name of a categorization scheme (or, in this case, a 'segmentation', which is a restricted case of categorization scheme). This scheme is for the general concept 'branch', presenting the instances of branch as divided into the categories that make up the scheme, according to the stated criteria. Each category's entry indicates being part of the scheme.

Commentary:

When you find this pattern -- under a 'name' designation with a 'Definition' caption that begins,

[the categorization scheme that is for the concept 'mentioned-other-concept' and subdivides mentioned-other-concept](#) based on...

or

[the segmentation that is for the concept 'mentioned-other-concept' and subdivides mentioned-other-concept](#) based on...

-- it is a compact, textual way to say multiple things, as follows:

1. that the entry being defined is a categorization scheme (or a categorization scheme that is a segmentation), and
2. that the mentioned concept is the concept that is the scheme is *for*.

Furthermore, each vocabulary entry for one of the categories in the scheme identifies itself as part of the scheme using a 'Necessity' caption. (Note that a category can be part of more than one scheme.)

B.4 Defining a Verb Concept for Convenience

The development of vocabularies and sets of elements of guidance often calls for trade-offs of redundancy (in the sense of defining a concept both directly and indirectly) against simplification of formulation and representation. Consider, for example, this business rule from EU-Rent (Annex G):

[It is necessary that each rental has exactly one requested car group.](#)

This is easy to grasp. Now, consider the full form of this rule if the rule were based solely on a sparse EU-Rent vocabulary. The rule would then be as follows:

[It is necessary that each rental has exactly one car group that is specified in the car movement that is included in the rental.](#)

As this simple example demonstrates, the full form of a rule (or advice) can become quite verbose when several verb concepts are involved.

The compact form of this rule makes use of the *short form* verb concept '[rental has requested car group](#)', a redundant concept that has been created for the purpose of simplification of formulation and representation. This verb concept specifies

its instances as being derived from (equivalent to) the concatenation of other verb concepts -- the *verbose* form -- as illustrated by the following entry that specifies the concept:

rental has requested car group

Necessity: A rental has a requested car group if and only if the requested car group is the car group that is specified in the car movement that is included in the rental.

This technique is particularly useful when the *short form* verb concept is used in a number of elements of guidance. This technique is particularly useful when the short form verb concept is used in a number of elements of guidance. Note, however, the choice to apply this pattern is a matter of practice. Decisions on reuse and redundancy are business decisions made by the semantic community (here, EU-Rent) to help it manage its body of shared meanings and vocabularies.

C Annex C - Conventions for Representing an SBVR-Style Vocabulary as a Concept Model Diagram

(informative)

C.1 Introduction

The purpose of the diagrams in Clauses 7 through 21 is to display the vocabulary graphically in a manner that is directly and fully consistent with SBVR's approach to specifying the semantics of business vocabularies and business rules. This kind of diagram is commonly called a concept model diagram (or vocabulary diagram). A concept model diagram is used to convey a business vocabulary (e.g., the SBVR vocabulary) in a visual way that is easily understood by its audience.

NOTE: The concept model diagrams contained in Clauses 7-21 do not add any semantics whatsoever to the SBVR specification. They merely picture the semantics already stated in the terminological entries in these clauses, which are the normative source of the semantics.

Some of the conventions used for concept model diagramming in Clauses 7-21 of the SBVR specification may appear familiar to users of UML, but they do not represent UML and carry absolutely no UML semantics. Thus, the diagrams should not be interpreted through UML eyes.

The meaning of each graphic convention used in Clauses 7-21 is exactly and entirely as explained in this Annex and in the terminological entries in Clauses 7-21 for terms used in this Annex (e.g., some diagramming conventions are specified by reference to 'general noun concept' which is defined in Clause 11.1.3). These diagramming conventions and their use in Clauses 7-21 have absolutely nothing to do with Clause 23, which builds entirely on the semantics of the text in the Clause 7-21 terminological entries without reference to the diagrams.

C.2 General Noun Concepts

Each terminological entry for a fundamental concept (i.e., a general noun concept that has a term-styled headword and does not show "situational role" or "aspect" as a Concept Type) is depicted as follows.

In a concept model diagram, the primary term for the concept is shown as a rectangle, labeled with the concept's primary term. If there are additional terms for the concept (i.e., synonyms) they can be shown within the rectangle, identified as such using the prefix 'also:', as depicted in Figure C.1.

Terminological entry (box on the left):

community

Definition: group of people having a particular unifying characteristic in common

Terminological entry (box on the right):

note

Definition: representation that annotates or explains

Synonym: remark

Synonym: comment

Depicted as:



Figure C.1 - Two general concepts

C.3 Individual Noun Concepts

Each terminological entry for an individual noun concept (i.e., an entry that has a name-styled headword) is depicted as follows.

The name given to an individual noun concept is shown as a rectangle with rounded corners. Optionally, the name may be followed by the term for its general concept, surrounded by curly braces.

While it is possible to have additional names for a given individual noun concept (i.e., names that are synonyms) as terminological entries in a vocabulary, the nonprimary names of an individual noun concept are not typically reflected in a concept model diagram. Figure C.2 depicts two individual noun concepts.

Terminological entry (box on the left):

Kind of Guidance Statement

Definition: the characterization scheme of the concept 'guidance statement' that classifies a guidance statement based on the surface syntax of the guidance statement

Terminological entry (box on the right):

Euro

Definition: the unit of money used in most European Union countries

currency unit

Definition: unit of some currency

Definition: Euro, GB Pound, US Dollar

Depicted as:

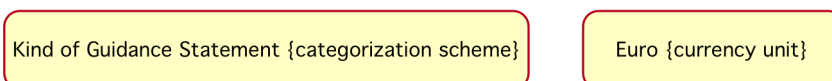

Figure C.2 - Two individual noun concepts

Alternatively, an individual noun concept can be depicted as a distinct kind of specialization of its related general concept (noun concept), as in Figure C.3.

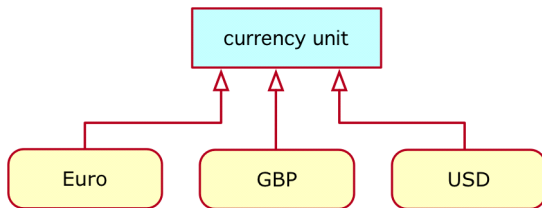

Figure C.3- Three individual noun concepts each as a distinct kind of specialization of a related general concept

C.4 Verb Concepts

Each terminological entry for a verb concept (i.e., an entry that has a verb-concept-wording-styled headword) is depicted as shown in one of the following sub clauses.

C.4.1 Binary Verb Concepts

Each terminological entry for a verb concept with exactly two verb concept roles - and no preferred verb concept wording with 'has' as its verb symbol - is depicted as follows.

The wording of a binary verb concept, other than one using 'has' (see C.4.2), is shown as a labeled line between rectangles. For clarity, the direction of the reading of the verb phrase is indicated with a solid arrowhead.

The wording of synonymous form(s) can also be shown in a concept model diagram. Figure C.4 illustrates two alternative presentations of a binary verb concept.

Terminological entry:

semantic community *shares understanding of* concept

Synonymous Form: concept has shared understanding by semantic community

Depicted (alternatively) as:



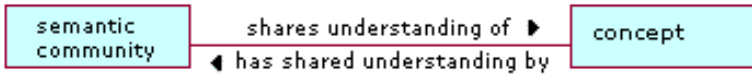

Figure C.4 - Three alternatives for presenting a binary verb concept

A 'starburst' symbol can be optionally used to emphasize that a line represents a verb concept. However, this symbol is usually omitted for binary verb concepts since their representation is straightforward except where objectified (see C.9). An explicit 'starburst' symbol is always used for nary and unary verb concepts (see C.4.3 and C.4.4).

C.4.2 Binary Verb Concepts using 'has'

Each terminological entry for a verb concept with exactly two verb concept roles and a preferred wording with 'has' as its verb symbol is depicted as follows.

For each verb concept wording that uses 'has', the verb symbol 'has' is omitted from the concept model diagram and the second role name is shown annotated on the end of the connection line. By this convention, a line with only an end term and no verb symbol (as shown in Figure C.5) is read as the verb symbol 'has' in the wording.

Terminological entries:

concept *has* necessary characteristic

necessary characteristic

Concept Type: role

Definition: characteristic that is always true of each instance of a given concept

Depicted as:



Figure C.5- Depicting the verb concept 'concept has necessary characteristic'

Even when there is no specialized second role in a binary verb concept using 'has', the second role term is still reflected on the diagram adjacent to the rectangle, as illustrated in Figure C.6. This gives a consistent interpretation to an unlabeled line in a concept model diagram.

Terminological entries:

behavioral business rule *has* enforcement level

enforcement level

Definition: position in a graded or ordered scale of values that specifies the severity of action imposed in order to put or keep a behavioral business rule in force

Depicted as:



Figure C.6- Depicting the verb concept 'behavioral business rule has enforcement level'

C.4.3 Verb Concepts with Arity of 3 or more

Each terminological entry for a verb concept with three or more verb concept roles is depicted as follows.

The diagramming convention used for a verb concept with more than two roles is a starburst with solid lines from its points to each noun concept rectangle. The full text of the primary verb concept wording is shown on the concept model diagram, adjacent to the starburst, with the placeholders underlined as shown in Figure C.7.

Terminological entry:

speech community *adopts* adopted definition *citing* reference

Definition: *the* speech community agrees that *the* definition identified by *the* reference can serve as the adopted definition

Depicted as:

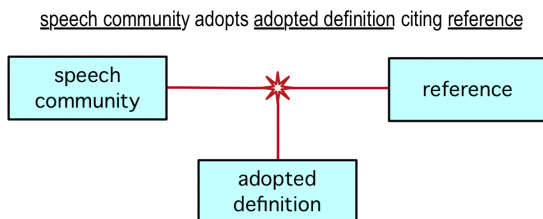

Figure C.7- Depicting a verb concept with arity of three

C.4.4 Unary Verb Concepts

Each terminological entry for a verb concept with exactly one verb concept role (i.e., a unary verb concept) is depicted as follows:

The diagramming convention used for a verb concept with one role is a starburst with a solid line from one of its points to the subject noun concept rectangle and the verb phrase annotated adjacent to the starburst, as shown in Figure C.8.

Terminological entry:

element of governance is directly enforceable

Definition: violations of **the element of governance** can be detected without the need for additional interpretation of **the element of governance**

Depicted as:

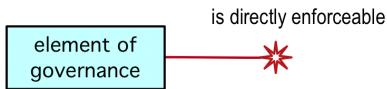

Figure C.8- Depicting the unary verb concept 'element of governance is directly enforceable'

C.5 Roles

In SBVR, a 'role' is a kind of noun concept. Multiple appearances of the same role term annotated adjacent to a concept rectangle is interpreted as meaning the same role concept.

C.5.1 Role depicted as a Connection End Term

In a concept model diagram, a role concept's term is most often shown as a label at one end of the verb concept's connection line. Figure C.9 shows a verb concept wording that uses the role 'signifier' (which ranges over the noun concept 'expression').

Terminological entries:

speech community regulates its usage of signifier

signifier

Concept Type: role

Definition: expression that is a linguistic unit or pattern, such as a succession of speech sounds, written symbols or gestures, used in a designation of a concept

Depicted as:

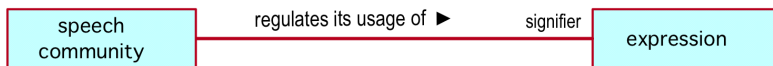

Figure C.9- Depicting a role as a connection end term

C.5.2 Role depicted as a Concept Rectangle

Since a 'role' in SBVR is a concept in its own right it can also be depicted in a concept model diagram as a concept rectangle, with a "role" tag used to denote that its concept type is 'role', as illustrated in Figure C.10.

Terminological entry:

unitary noun concept

Concept Type: role

Definition: noun concept that corresponds to at most one thing at a time

Depicted as:

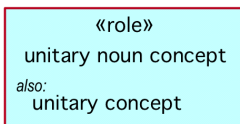

Figure C.10- Depicting a role as a concept rectangle using the "<<role>> tag

C.5.3 Term for a Role in a Verb Concept Wording

When a term for a role is used in a verb concept wording, and that wording is not an attributive form (e.g., “a *has* b”), then the term for the role needs to be shown as part of the text on the verb concept line. It is not shown as an association end because that would imply an attribute form (e.g., ‘has’). Instead, the term for the role is underlined and shown along with the verbal part of the verb concept wording, as illustrated in Figure C.11.

Terminological entry:

variable is free within semantic formulation

Synonymous Form: semantic formulation includes variable without binding

Definition: the semantic formulation employs the variable, but does not introduce it

Depicted as:

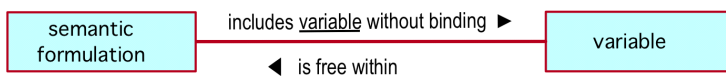

Figure C.11- Example of a term for a role in a verb concept wording

C.6 Generalization/Specialization

The terminological entry for a concept that is a specialization (category) of a more general concept is depicted as follows.

C.6.1 Noun Concept Generalization/Specialization

The terminological entry for a noun concept can specify the concept's more general concept (the concept with the broader extension) in one of two forms:

1. style the first term of the Definition text, which means that that designated concept is the defined concept's 'more general concept'
2. use the 'General Concept' caption to specify a term that means the defined concept's 'more general concept'

In a concept model diagram, noun concept generalization is shown with the 'more general concept' and 'category' concept rectangles connected by a line with an arrowhead at the 'more general concept' end, as shown in Figure C.12.

Terminological entry (Form 1):

semantic community

Definition: community whose unifying characteristic is a shared understanding (perception) of the things that they have to deal with

Terminological entry (Form 2):

concept

Definition: unit of knowledge created by a unique combination of characteristics

General Concept: meaning

Depicted as (for both Forms):



Figure C.12- Two examples of noun concept generalization/specialization

C.6.2 Role Concept Generalization/Specialization

A role noun concept can be defined as a specialization of another role concept as follows.

As a noun concept, a role concept can be defined as a terminological entry using one of the two forms described in C.6.1. In a concept model diagram, role concept generalization is depicted by annotating the more specialized role as subsetting its more generalized concept, as shown in Figure C.13.

Terminological entries (Form 1):

implied characteristic

Concept Type: role

Definition: necessary characteristic of a given concept that is not incorporated by the concept

necessary characteristic

Concept Type: role

Definition: characteristic that is always true of each instance of a given concept

Depicted as:

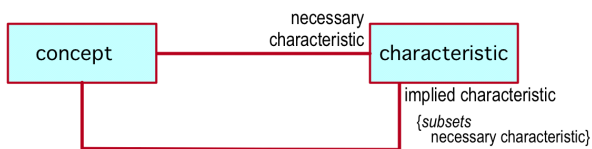

Figure C.13- One role concept that specializes another

C.6.3 Verb Concept Generalization/Specialization

A verb concept can be defined as a specialization of another verb concept as follows.

The terminological entry for a verb concept can specify that it is a specialization of another verb concept by using the verb symbol of the more generalized verb concept in a fully-formal definition, as illustrated below. In a concept model diagram, verb concepts generalization is depicted by annotating the more specialized verb concept as subsetting its more generalized verb concept, as shown in Figure C.14.

Terminological entries:

closed semantic formulation formulates meaning

Definition: the meaning is structured by the closed semantic formulation

closed logical formulation means proposition

Definition: the closed logical formulation *formulates* the proposition

Depicted as:

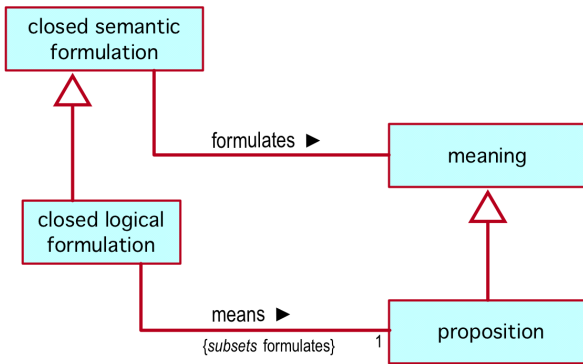

Figure C.14 - One verb concept that specializes another

C.7 Categorization

The terminological entry for a concept that specifies a scheme for organizing a set of concepts whose instances are partitioned based on some criterion is depicted as follows.

C.7.1 Categorization Schemes and Categories

Each terminological entry for a categorization scheme is presented as an entry that has a Name-styled headword that reflects the name of the scheme. The wording of the Definition text uses the pattern illustrated below. Each concept that is part of the scheme is specified using a Necessity, which is either part of the scheme's entry or the entry for the category concept.

In a concept model diagram, the name of a categorization scheme is annotated adjacent to the set of categories, e.g., 'Kind of Guidance Statement'.

Terminological entry:

Kind of Guidance Statement

- Definition: the categorization scheme of the concept 'guidance statement' that classifies a guidance statement based on the surface syntax of the guidance statement
- Necessity: The concept 'business policy statement' is included in Kind of Guidance Statement.
- Necessity: The concept 'rule statement' is included in Kind of Guidance Statement.
- Necessity: The concept 'advice statement' is included in Kind of Guidance Statement.

Depicted as:

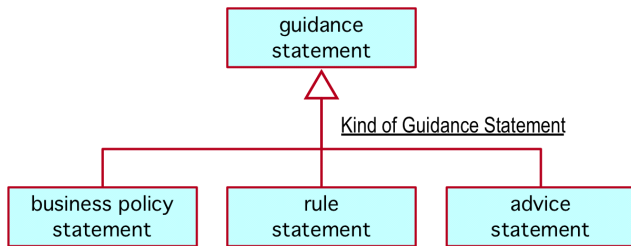

Figure C.15 - Depicting a categorization scheme

A set of categories specified as disjoint via definitional rules can be depicted as being mutually exclusive by bringing the generalization lines together, as shown in Figure C.16. Contrast this with the diagram on the right in Figure C.16, which reflects two independent specializations - i.e., a community can be both a semantic community and a speech community. There is no restriction indicated.

Terminological entries for a set of mutually-exclusive categories (diagram on the left):

term

Definition: verbal designation of a general concept that is in a given subject field
General Concept: designation

name

Definition: verbal designation of an individual noun concept
General Concept: designation
Necessity: **No name is a term.**

Terminological entries for a set of mutually-exclusive categories (diagram on the right):

designation

Definition: representation of a concept by a sign which denotes it

definition

Definition: representation of a concept by a descriptive statement [expression] which serves to differentiate it from related concepts

Depicted as:



Figure C.16 - Depicting mutually-excluding categories (diagram on the left) vs. independent specializations (diagram on the right)

C.7.2 Categories and Categorization Types (Concept Types)

It is not typical to show categorization types (concept types) in a concept model diagram but, when needed, a variation of the diagramming conventions described in C.7.1 has been adapted, as shown in C.17. The categories of the more general concept are shown in the typical way, with the addition of the categorization type term (surrounded by curly braces) annotated adjacent to the categorization line. The more general concept also reflects its 'has' verb concept connection to the categorization type concept.

Terminological entries:

rental rate type

Concept Type: [categorization type](#)
Definition: [concept that specializes the concept 'rental rate' and that](#) classifies [a rental rate](#) by its unit

rental rate

Definition: [number of some currency unit that](#) is used for calculating [rental prices](#)

rental rate has rental rate type

cash rental rate

Definition: [rental rate that is a currency amount](#)
Concept Type: [rental rate type](#)

points rental rate

Definition: [rental rate that is a number of club points](#)
Concept Type: [rental rate type](#)

Depicted as:

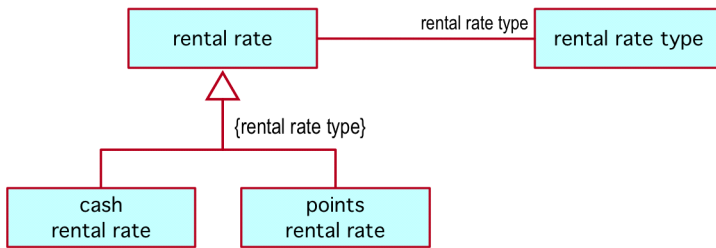

Figure C.17 - One example of depicting the categories specified by a categorization type

C.8 Partitive Verb Concept

Concept model diagrams depict concepts related by composition (a part/whole relationship) using a line connecting the part/whole boxes, annotated with a verb symbol conveying which concept is the 'part' and which the 'whole' in the relationship. SBVR specifies no particular verb symbol to mean part/whole, but some typical verb symbols used are 'includes', 'contains', 'is in', 'is composed of'.

The diagram on the left of Figure C.18 shows the verb symbols for the partitive verb concepts that 'body of shared meanings' is involved in. The left diagram also illustrates the use of a different the verb symbol, 'contains', for a partitive connection.

Note that the subscripts in the verb concept wording of the terminological entry are not reflected on the diagram.

The diagram on the right of Figure C.18 shows a third verb symbol often used for a partitive connection.

Terminological entries (for the diagram on the left):

[body of shared meanings](#) *includes* [body of shared concepts](#)
[body of shared meanings](#) *includes* [body of shared guidance](#)
[body of shared meanings](#)₁ *contains* [body of shared meanings](#)₂

Terminological entries (for the diagram on the right):

[thing](#) *is in* [set](#)

Depicted as:

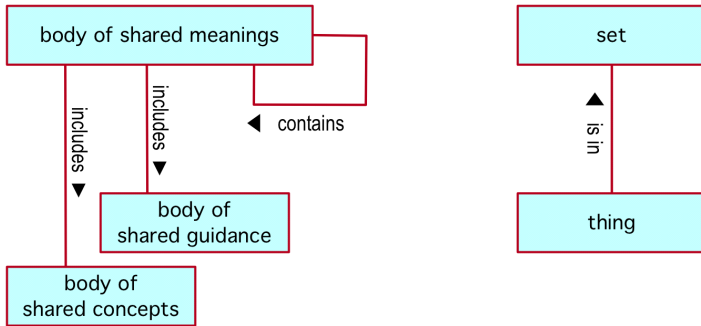

Figure C.18- Two examples of partitive verb concept

C.9 Verb Concept Objectification

Verb concept objectification pairs two terminological entries, one for a verb concept and the second for the general noun concept that objectifies the verb concept. These two entries are for coextensive concepts; even though these are distinct entries in the vocabulary, they have the same instances.

The verb concept starburst is used to depict objectification in a concept model diagram as follows: A starburst is connected by solid lines to the noun concepts involved in the verb concept; a dashed line connects the verb concept starburst to the related noun concept (the objectification). This is shown in Figure C.19.

Terminological entries:

rented car is recovered from recovery location to branch

Definition: the rented car of a rental is reclaimed from the recovery location and taken to the nearest convenient branch

car recovery

Definition: actuality that a given rented car is recovered from a given recovery location to a given branch

Depicted as:

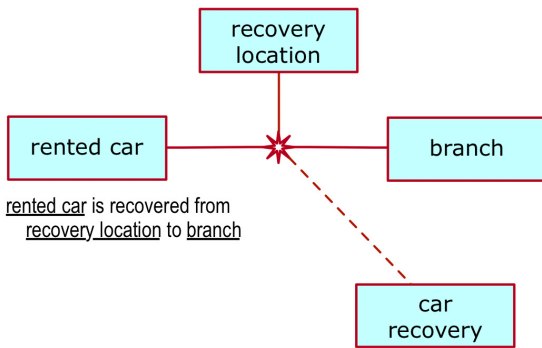

Figure C.19- Depicting verb concept objectification

The same convention is used when the objectified verb concept is binary, as shown in Figure C.20.

Terminological entries:

expression represents meaning

Definition: the expression portrays or signifies the meaning

representation

Definition: actuality that a given expression represents a given meaning

Depicted as:

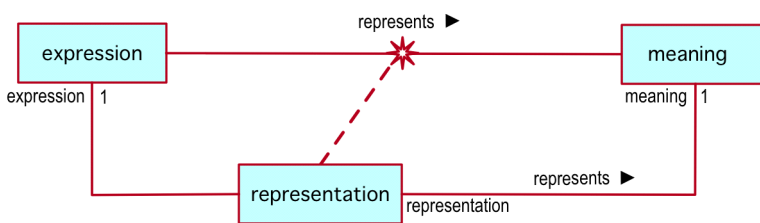

Figure C.20 - Depicting verb concept objectification of a binary verb concept

C.10 Multiplicities

Multiplicity is annotated in a diagram only to reflect a formally-stated restriction on multiplicity in a definition or a definitional rule involving a verb concept. If no multiplicity restriction appears at the end of a line representing a verb concept, the implication is that no restrictions are specified in the terminological entries being depicted. In other words, absence means no minimum and/or maximum restriction applies.

Annex A.2.1.1 documents the SBVR Structured English keywords that are used for the expression of multiplicities in terminological entries. The table in Figure C-21 shows those keywords along with the corresponding text used in a concept model diagram.

<i>SBVR Structured English Keyword</i>	<i>Kind of Logical Formulation</i>	<i>Concept Model Diagram Annotation</i>
at least one	<u>existential quantification</u>	MIN 1
at least <i>n</i>	<u>at-least-n quantification</u>	MIN <i>n</i>
at most one	<u>at-most-one quantification</u>	MAX 1
at most <i>n</i>	<u>at-most-n quantification</u>	MAX <i>n</i>
exactly one	<u>exactly-one quantification</u>	1
exactly <i>n</i>	<u>exactly-n quantification</u>	<i>n</i>
at least <i>n</i> and at most <i>m</i>	<u>numeric range quantification</u>	MIN <i>n</i> , MAX <i>m</i>
more than one	<u>at-least-n quantification</u> with <i>n</i> = 2	MIN 2

Figure C.21 - Multiplicity keywords and their concept model diagram representation

Figure C-22 illustrates the use of keywords in three definitional rules and the corresponding annotations in a concept model diagram.

Terminological entry:

- Necessity: Each placeholder *is in* exactly one verb concept wording.
- Necessity: Each verb concept wording *has* at least one placeholder.
- Necessity: Each placeholder *has* at most one starting character position.

Depicted (alternatively) as:

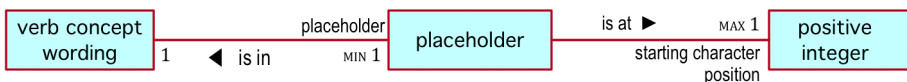

Figure C.22 - Multiplicities in a concept model diagram

Annex D - Additional References

(informative)

D.1 Bibliography / Normative References

[AH] *American Heritage Dictionary*.

[Anto2001] Antonelli, A. *Non-Monotonic Logic*, Stanford Encyclopedia of Philosophy, 2001. Available from <http://plato.stanford.edu/entries/logic-nonmonotonic/>

[Bloer1996] Bloesch, A.C., and Terry A. Halpin. "ConQuer: a Conceptual Query Language". In *Proc. ER'96: 15th Int. Conf. on Conceptual Modeling*, 121-133: Springer LNCS, 1996. Available from <http://www.orm.net/pdf/ER96.pdf>

[Bloer1997] _____. "Conceptual Queries using ConQuer-II". In *Proc. ER'97: 16th Int. Conf. on Conceptual Modeling*, 113-126: Springer LNCS, 1997. Available from <http://www.orm.net/pdf/ER97-final.pdf>

[BMM] Business Rules Group. *The Business Motivation Model ~ Business Governance in a Volatile World*. 1.2 ed., Sept. 2005. Originally published as *Organizing Business Plans ~ The Standard Model for Business Rule Motivation*, Nov. 2000. Available from <http://www.BusinessRulesGroup.org>

[BRM] Business Rules Group. Ronald G. Ross, ed. *Business Rules Manifesto ~ The Principles of Rule Independence*. 1.2 ed. The Business Rules Group, 2003. Updated Jan. 8, 2003. PDF. Available from <http://www.BusinessRulesGroup.org/brmanifesto.htm>

[BRG2002] Business Rules Group. *Defining Business Rules ~ What Are They Really?* 4th ed., July 2002. Originally published as *GUIDE Business Rules Project Report*, 1995. Available from <http://www.BusinessRulesGroup.org>

[BRJ2005] Editors of BRCommunity.com. "A Brief History of the Business Rule Approach". *The Business Rules Journal* 6, no. 1 (2005). Available from <http://www.BRCommunity.com/a2005/b216.html>

[CDP] *The Cambridge Dictionary of Philosophy*. 2nd ed.: Cambridge University Press, 1999.

[CSILL] *Cognitive Science Initiative: Language Lexicon*. University of Houston. Available from <http://www.hfac.uh.edu/COGSCI/lang/Entries/>

[Dean1997] Dean, Neville. *The Essence of Discrete Mathematics*, The Essence of Computing Series: Prentice-Hall, 1997.

[Fitt2002 (or TTGG)] Fitting, Melvin. *Types, Tableaus, and Gödel's God*, Trends in Logic, Studia Logica Library. Dordrecht, the Netherlands: Kluwer Academic Publishers, 2002.

[Girl2000 (or MLP)] Girle, Rod A. *Modal Logics and Philosophy*: McGill-Queen's University Press, 2000.

[Halp1989 (or HALT89)] Halpin, Terry A. “A Logical Analysis of Information Systems: Static Aspects of the Data-oriented Perspective”. PhD thesis, Department of Computer Science, University of Queensland, 1989.

[Halp1998] _____. “Object-Role Modeling (ORM/NIAM)”. In *Handbook on Architectures of Information Systems*. Heidelberg: Springer, 1998.

[Halp2000] _____. *Object-Role Modeling: An Overview*. San Francisco: Springer, 2000. Available from <http://www.orm.net/pdf/springer.pdf>

[Halp2001 (or IMRD)] _____. *Information Modeling and Relational Databases*. San Francisco: Morgan Kaufmann, 2001.

[Halp2003a] _____. “Verbalizing Business Rules: Part 1”. *The Business Rules Journal* 4, no. 4 (2003). Available from <http://www.BRCommunity.com/a2003/b138.html>

[Halp2003b] _____. “Verbalizing Business Rules: Part 2”. *The Business Rules Journal* 4, no. 6 (2003). Available from <http://www.BRCommunity.com/a2003/b152.html>

[Halp2003c] _____. “Verbalizing Business Rules: Part 3”. *The Business Rules Journal* 4, no. 8 (2003). Available from <http://www.BRCommunity.com/a2003/b163.html>

[Halp2003d] _____. “Verbalizing Business Rules: Part 4”. *The Business Rules Journal* 4, no. 10 (2003). Available from <http://www.BRCommunity.com/a2003/b172.html>

[Halp2004 (or HALT2004)] _____. “Information Modeling and Higher-Order Types”. In *Proc. CAiSE'04 Workshops*, eds. J. Grundspenkis and M. Kirkova, 1, 233-248: Riga Tech. University, 2004. Available from <http://www.orm.net/pdf/EMMSAD2004.pdf>

[Halp2004b] _____. “Business Rule Verbalization”. In *Lecture Notes in Informatics*, eds. A. Doroshenko, Terry A. Halpin and S. Liddle, P-48, 39-52. Salt Lake City: Proc. ISTA-2004, 2004.

[Halp2004c] _____. “Verbalizing Business Rules: Part 5”. *The Business Rules Journal* 5, no. 2 (2004). Available from <http://www.BRCommunity.com/a2004/b179.html>

[Halp2004d] _____. “Verbalizing Business Rules: Part 6”. *The Business Rules Journal* 5, no. 4 (2004). Available from <http://www.BRCommunity.com/a2004/b183.html>

[Halp2004e] _____. “Verbalizing Business Rules: Part 7”. *The Business Rules Journal* 5, no. 7 (2004). Available from <http://www.BRCommunity.com/a2004/b198.html>

[Halp2004f] _____. “Verbalizing Business Rules: Part 8”. *The Business Rules Journal* 5, no. 9 (2004). Available from <http://www.BRCommunity.com/a2004/b205.html>

[Halp2004g] _____. “Verbalizing Business Rules: Part 9”. *The Business Rules Journal* 5, no. 12 (2004). Available from <http://www.BRCommunity.com/a2004/b215.html>

[Halp2005a] _____. “Verbalizing Business Rules: Part 10”. *The Business Rules Journal* 6, no. 4 (2005). Available from <http://www.BRCommunity.com/a2005/b229.html>

[Halp2005b] _____. “Verbalizing Business Rules: Part 11”. *The Business Rules Journal* 6, no. 6 (2005). Available from <http://www.BRCommunity.com/a2005/b238.html>

[Halp2005c] _____. “Verbalizing Business Rules: Part 12”. *The Business Rules Journal* 6, no. 10 (2005). Available from <http://www.BRCommunity.com/a2005/b252.html>

[Halp2005d] _____. “Verbalizing Business Rules: Part 13”. *The Business Rules Journal* 6, no. 12 (2005). Available from <http://www.BRCommunity.com/a2005/b261.html>

[Halp1981 (or DL)] Halpin, Terry A., and Rod A. Girle. *Deductive Logic*. 2nd ed. Brisbane: Logiquest, 1981.

[Hunt1971 (or META)] Hunter, Geoffrey. *An Introduction to the Metatheory of Standard First Order Logic*: University of California Press, 1971.

[IETF RFC 2396] Berners-Lee, Tim, R. Fielding, and L. Masinter. *Uniform Resource Identifiers (URI): Generic Syntax*. The Internet Society, 1998. Updated August 1998. Available from <http://www.ietf.org/rfc/rfc2396.txt>

[ISO6093] International Organization for Standardization (ISO). *Information processing - Representation of numerical values in character strings for information interchange*. ISO, 1985.

[ISO704] _____. *Terminology work - Principles and Methods*. English ed.: ISO, 2000.

[ISO1087-1] _____. *Terminology work - Vocabulary - Part 1: Theory and Application*. English/French ed.: ISO, 2000.

[ISO860] _____. *Terminology work - Harmonization of Concepts and Terms*. ISO, 1996.

[ISO639-2] _____. *Codes for the Representation of Names of Languages-- Part 2: Alpha-3 Code*. Library of Congress, 2002. Available from <http://www.loc.gov/standards/iso639-2/langcodes.html>

[ISO/IEC CD 24707] _____. *Information technology -- Common Logic (CL) -- A Framework for a Family of Logic-Based Languages*: ISO, 2005. Available from <http://www.iso.org/iso/en/CatalogueDetailPage.CatalogueDetail?CSNUMBER=39175>

[Levi1983 (or LEVS)] Levinson, Stephen C. *Pragmatics*, Cambridge Textbooks in Linguistics: Cambridge University Press, 1983.

[MATH] *PlanetMath.org*. Available from <http://planetmath.org/encyclopedia>

[Mend1997 (or MEN97)] Mendelson, Elliott. *Introduction to Mathematical Logic*. 4th ed.: Chapman & Hall, 1997.

[MWCD] *Merriam-Webster Collegiate Dictionary*.

[MWDS] *Merriam-Webster Dictionary of Synonyms*.

[MWU] *Merriam-Webster Unabridged*.

[Nijs1977] Nijssen, Sjr. "On the Gross Architecture for the Next Generation Database Management Systems." In: *Proc. IFIP'77, 1977 IFIP Working Conf. on Modelling in Data Base Management Systems*, ed. B. Gilchrist, 327-335: North Holland Publishing Company, 1977.

[Nijs1978] _____. "A Framework for Discussion." In: *ISO/TC97/SC5/WG3 and comments on 78.04/01 and 78.05/03*, 1-144.

[Nijs1980] _____. "A Framework for Advanced Mass Storage Applications." In: *Proc. IFIP MEDINFO'80, 3rd World Conference on Medical Informatics*: North Holland Publishing Company, 1980.

[Nijs1986] _____. "On Experience with Large-scale Teaching and Use of Fact-Based Conceptual Schemas in Industry and University." In: *Proc. DS-1'85: IFIP WG 2.6 Working Conference on Data Semantics*, eds. T.B. Steel and R. Meersman, 189-204: North Holland Publishing Company, 1986.

[Nijs2006] Nijssen, Sjr, and R. Bijlsma. "A Conceptual Structure of Knowledge as a Basis for Instructional Designs." In: *Proc. ICALT'06, IEEE: 6th Int. Conf. on Advanced Learning Technologies*, eds. R. Kinshuk, P. Koper, P. Kommers, D. Kirschner, G. Sampson, and W.E. Didderen, 7-9: IEEE, 2006.

[NODE] *The New Oxford Dictionary of English*.

[Nolt1998 (or LSO)] Nolt, John, Dennis Rohatyn, and Achille Varzi. *Logic*. 2nd ed., Schaum's Outlines. New York: McGraw-Hill, 1998.

[ODE] *Oxford Dictionary of English*.

[OSM] *Organizational Structure Metamodel*: OMG, 2005.

[Peik (or PEIL)] Peikoff, Leonard. "The Analytic-Synthetic Dichotomy". In *Rand1990*, 88-121.

[Rand1990 (or RANA90)] Rand, Ayn. *Introduction to Objectivist Epistemology*. expanded 2nd ed. New York: Meridian, 1990.

[Ross1997] Ross, Ronald G. *The Business Rule Book -- Classifying, Defining and Modeling Rules*. 2nd ed. Houston, TX: Business Rule Solutions, Inc., 1997. Originally published as *The Business Rule Book (1st Ed.)*, 1994. Available from <http://www.BRSolutions.com>

[Ross2003] _____. *Principles of the Business Rule Approach*. Boston, MA: Addison-Wesley, 2003. Available from <http://www.BRSolutions.com>

[Ross2005] _____. *Business Rule Concepts: Getting to the Point of Knowledge*. 4th ed.: Business Rule Solutions, LLC, 2013. Available from <http://www.BRSolutions.com>

[RuleSpeak] Business Rule Solutions, LLC, 2001-2014. PDF. Available from <http://www.rulespeak.com/en/>

[SEP] *Stanford Encyclopedia of Philosophy*. Edward N. Zalta, ed. The Metaphysics Research Lab, Center for the Study of Language and Information, Stanford University. Available from <http://plato.stanford.edu/>

[SOED] *Shorter Oxford Dictionary of English*.

[Sowa] . “Ontology, Metadata, and Semiotics”. John Sowa Ontology Website.
Available from <http://www.jfsowa.com/ontology/ontometa.htm>

[SubePLTS (or PLTS)] Suber, Peter. *Propositional Logic Terms and Symbols*. Philosophy Department, Earlham College, 1997. Available from <http://www.earlham.edu/~peters/courses/log/terms2.htm>

[SubeGFOL (or GFOL)] _____. *Glossary of First-Order Logic*. Philosophy Department, Earlham College, 1999-2002. Available from <http://www.earlham.edu/~peters/courses/logsys/glossary.htm>

[UML2infr] Object Management Group (OMG). *Unified Modeling Language: Infrastructure*. Ver. 2.0: OMG.

[Unicode4] “The Unicode Standard, Version 4.0.0”. In *The Unicode Standard, Version 4.0*. Boston, MA: Addison-Wesley, 2003. Available from <http://www.unicode.org/versions/Unicode4.0.0/b1.pdf>

[USG] The Unicode Consortium. *Glossary of Unicode Terms*. 1991-205. Updated Nov. 17 2004. Available from <http://www.unicode.org/glossary/>

[W3ID] *Webster’s 3rd New International Dictionary*.

[WD] *Webster’s Dictionary*.

[XMI2.1] *XML Metadata Interchange (XMI)*. Ver. 2.1: OMG.

