

Date: December 2025



Specification Common Elements (SCE)

Version 1.0

OMG Document Number: formal/25-12-01

Normative reference: <https://www.omg.org/spec/SCE>

Copyright © 2022-2024, Adaptive
Copyright © 2022-2024, agnos.ai UK Ltd
Copyright © 2021-2024, Airbus Group
Copyright © 2021-2024, Auxilium Technology Group, LLC
Copyright © 2021-2024, Book Zurman, Inc.
Copyright © 2021-2024, Camunda Services GmbH
Copyright © 2021-2024, BPM Advantage Consulting, Inc.
Copyright © 2025, EDM Council, Inc.d/b/a EDM Association
Copyright © 2021-2024, FICO
Copyright © 2021-2024, Mayo Clinic
Copyright © 2021-2024, MDIX, Inc.
Copyright © 2021-2024, Red Hat, Inc.
Copyright © 2021-2024, Sparx Systems, Inc.
Copyright © 2021-2024, Thematrix Partners, LLC
Copyright © 2021-2024, Trisotech
Copyright © 2022-2024, University of Utah
Copyright © 2021-2024, Xzyos, LLC
Copyright © 2022-2025, Object Management Group, Inc.

USE OF SPECIFICATION - TERMS, CONDITIONS & NOTICES

The material in this document details an Object Management Group specification in accordance with the terms, conditions and notices set forth below. This document does not represent a commitment to implement any portion of this specification in any company's products. The information contained in this document is subject to change without notice.

LICENSES

The companies listed above have granted to the Object Management Group, Inc. (OMG) a nonexclusive, royalty-free, paid up, worldwide license to copy and distribute this document and to modify this document and distribute copies of the modified version. Each of the copyright holders listed above has agreed that no person shall be deemed to have infringed the copyright in the included material of any such copyright holder by reason of having used the specification set forth herein or having conformed any computer software to the specification.

Subject to all of the terms and conditions below, the owners of the copyright in this specification hereby grant you a fully-paid up, non-exclusive, nontransferable, perpetual, worldwide license (without the right to sublicense), to use this specification to create and distribute software and special purpose specifications that are based upon this specification, to copy, modify, and distribute this specification as provided under the Copyright Act; provided that: (2) the use of the specifications is for informational purposes and will not be copied or posted on any network computer or broadcast in any media and will not be otherwise resold or transferred for commercial purposes; and (3) no modifications are made to this specification. This limited permission automatically terminates without notice if you breach any of these terms or conditions. Upon termination, you will destroy immediately any copies of the specifications in your possession or control.

PATENTS

The attention of adopters is directed to the possibility that compliance with or adoption of OMG specifications may require use of an invention covered by patent rights. OMG shall not be responsible for identifying patents for which a license may be required by any OMG specification, or for conducting legal inquiries into the legal validity or scope of those patents that are brought to its attention. OMG specifications are prospective and advisory only. Prospective users are responsible for protecting themselves against liability for infringement of patents.

GENERAL USE RESTRICTIONS

Any unauthorized use of this specification may violate copyright laws, trademark laws, and communications regulations and statutes. This document contains information which is protected by copyright. All Rights Reserved. No part of this work covered by copyright herein may be reproduced or used in any form or by any means--graphic, electronic, or mechanical, including photocopying, recording, taping, or information storage and retrieval systems--without permission of the copyright owner.

DISCLAIMER OF WARRANTY

WHILE THIS PUBLICATION IS BELIEVED TO BE ACCURATE, IT IS PROVIDED "AS IS" AND MAY CONTAIN ERRORS OR MISPRINTS. THE OBJECT MANAGEMENT GROUP AND THE COMPANIES LISTED ABOVE MAKE NO WARRANTY OF ANY KIND, EXPRESS OR IMPLIED, WITH REGARD TO THIS PUBLICATION, INCLUDING BUT NOT LIMITED TO ANY WARRANTY OF TITLE OR OWNERSHIP, IMPLIED WARRANTY OF MERCHANTABILITY OR WARRANTY OF FITNESS FOR A PARTICULAR PURPOSE OR USE. IN NO EVENT SHALL THE OBJECT MANAGEMENT GROUP OR ANY OF THE COMPANIES LISTED ABOVE BE LIABLE FOR ERRORS CONTAINED HEREIN OR FOR DIRECT, INDIRECT, INCIDENTAL, SPECIAL, CONSEQUENTIAL, RELIANCE OR COVER DAMAGES, INCLUDING LOSS OF PROFITS, REVENUE, DATA OR USE, INCURRED BY ANY USER OR ANY THIRD PARTY IN CONNECTION WITH THE FURNISHING, PERFORMANCE, OR USE OF THIS MATERIAL, EVEN IF ADVISED OF THE POSSIBILITY OF SUCH DAMAGES.

The entire risk as to the quality and performance of software developed using this specification is borne by you. This disclaimer of warranty constitutes an essential part of the license granted to you to use this specification.

RESTRICTED RIGHTS LEGEND

Use, duplication or disclosure by the U.S. Government is subject to the restrictions set forth in subparagraph (c) (1) (ii) of The Rights in Technical Data and Computer Software Clause at DFARS 252.227-7013 or in subparagraph (c)(1) and (2) of the Commercial Computer Software - Restricted Rights clauses at 48 C.F.R. 52.227-19 or as specified in 48 C.F.R. 227-7202-2 of the DoD F.A.R. Supplement and its successors, or as specified in 48 C.F.R. 12.212 of the Federal Acquisition Regulations and its successors, as applicable. The specification copyright owners are as indicated above and may be contacted through the Object Management Group, 9C Medway Road PMB 274, Milford, MA, 01757 U.S.A.

TRADEMARKS

CORBA®, CORBA logos®, FIBO®, Financial Industry Business Ontology®, FINANCIAL INSTRUMENT GLOBAL IDENTIFIER®, IIOP®, IMM®, Model Driven Architecture®, MDA®, Object Management Group®, OMG®, OMG Logo®, SoaML®, SOAML®, SysML®, UAF®, Unified Modeling Language®, UML®, UML Cube Logo®, VSIPL®, and XMI® are registered trademarks of the Object Management Group, Inc.

For a complete list of trademarks, see: https://www.omg.org/legal/tm_list.htm. All other products or company names mentioned are used for identification purposes only, and may be trademarks of their respective owners.

COMPLIANCE

The copyright holders listed above acknowledge that the Object Management Group (acting itself or through its designees) is and shall at all times be the sole entity that may authorize developers, suppliers and sellers of computer software to use certification marks, trademarks or other special designations to indicate compliance with these materials.

Software developed under the terms of this license may claim compliance or conformance with this specification if and only if the software compliance is of a nature fully matching the applicable compliance points as stated in the specification. Software developed only partially matching the applicable compliance points may claim only that the software was based on this specification but may not claim compliance or conformance with this specification. In the event that testing suites are implemented or approved by Object Management Group, Inc., software developed using this specification may claim compliance or conformance with the specification only if the software satisfactorily completes the testing suites.

OMG's Issue Reporting Procedure

All OMG specifications are subject to continuous review and improvement. As part of this process, we encourage readers to report any ambiguities, inconsistencies, or inaccuracies they may find by completing the Issue Reporting Form listed on the main web page <https://www.omg.org>, under Specifications, Report a Bug/Issue.

Table of Contents

1	Scope.....	1
2	Conformance.....	1
3	References.....	1
3.1	Normative References.....	1
3.2	Non-normative References	1
4	Terms and Definitions.....	2
5	Symbols.....	2
6	Additional Information	2
6.1	Conventions	2
6.2	Typographical and Linguistic Conventions and Style.....	2
6.3	Display of Metamodel Diagrams.....	3
6.4	Use of Text, Color, Size, and Lines in a Diagram	4
6.5	Abbreviations.....	4
6.6	Structure of this Document	5
6.7	Acknowledgements.....	5
7	Overview.....	7
8	SCE Metamodel.....	9
8.1	SCE Core Elements.....	9
8.1.1	BaseElement	10
8.1.2	RootElement	11
8.1.3	ElementType.....	12
8.1.4	TypedElement.....	13
8.1.5	Category.....	13
8.1.6	Packaging.....	15
8.1.6.1	Package	16
8.1.6.2	Model.....	17
8.2	Annotations	18
8.2.1	Attachment.....	19
8.2.2	Documentation.....	19
8.3	External Relationships	20
8.3.1	Relationship	21
8.3.2	RelationshipDirection	22
8.3.3	Import.....	22
8.4	Internal Relationships	22
8.4.1	ElementRelationship.....	23
8.4.2	ElementRelationshipType.....	24
8.5	BPM+ Modeling	25
8.5.1	ModelArtifact.....	25
8.5.2	Association.....	26
8.5.3	AssociationDirection.....	28
8.5.4	Group	28
8.5.5	TextAnnotation	29
8.5.6	Diagram Artifact Connection Rules.....	30
8.6	KindSets.....	30

8.6.1	KindSet	31
8.6.2	Kind.....	32
8.6.3	RelationshipKindSet	32
8.6.4	RelationshipKind	34
9	SCE Library	37
9.1	RelationshipKinds.....	37
10	Exchange Formats.....	39
10.1	Interchanging Incomplete Models	39
10.2	XSD.....	39
10.2.1	Document Structure	39
10.2.2	References within the SCE XSD	40
11	SCE Diagram Interchange (SCE DI)	41
11.1	Scope.....	41
11.2	Diagram Definition and Interchange	41
11.3	SCE Diagram Interchange Meta-Model	41
11.3.1	How to read this chapter	41
11.3.2	Overview.....	41
11.3.3	Measurement Unit.....	42
11.3.4	Elements.....	42
11.3.4.1	Diagrams.....	42
11.3.4.2	Diagram	43
11.3.4.3	DiagramElement.....	44
11.3.4.4	Shape	45
11.3.4.5	Edge	46
11.3.4.6	Label.....	47
11.3.4.7	Style	48
11.4	Notation.....	50
11.4.1	Labels.....	50
11.4.2	Shape Resolution	50
11.4.2.1	Diagram Artifacts	50
11.4.3	Edge Resolution	51
11.4.3.1	Association	51
	Annex A: Mapping to BPMN.....	52
	Annex B: Mapping to CMMN.....	55
	Annex C: Mapping to DMN	57

Preface

OMG

Founded in 1989, the Object Management Group, Inc. (OMG) is an open membership, not-for-profit computer industry standards consortium that produces and maintains computer industry specifications for interoperable, portable, and reusable enterprise applications in distributed, heterogeneous environments. Membership includes Information Technology vendors, end users, government agencies, and academia.

OMG member companies write, adopt, and maintain its specifications following a mature, open process. OMG's specifications implement the Model Driven Architecture® (MDA®), maximizing ROI through a full-lifecycle approach to enterprise integration that covers multiple operating systems, programming languages, middleware and networking infrastructures, and software development environments. OMG's specifications include: UML® (Unified Modeling Language™); CORBA® (Common Object Request Broker Architecture); CWM™ (Common Warehouse Metamodel); and industry-specific standards for dozens of vertical markets.

More information on the OMG is available at <https://www.omg.org/>.

OMG Specifications

As noted, OMG specifications address middleware, modeling and vertical domain frameworks. All OMG Specifications are available from the OMG website at:

<https://www.omg.org/spec>

All of OMG's formal specifications may be downloaded without charge from our website. (Products implementing OMG specifications are available from individual suppliers.) Copies of specifications, available in PostScript and PDF format, may be obtained from the Specifications Catalog cited above or by contacting the Object Management Group, Inc. at:

OMG Headquarters
9C Medway Road
PMB 274
Milford, MA 01757
USA
Tel: +1-781-444-0404
Fax: +1-781-444-0320
Email: pubs@omg.org

Certain OMG specifications are also available as ISO standards. Please consult <https://www.iso.org>

Issues

All OMG specifications are subject to continuous review and improvement. As part of this process, we encourage readers to report any ambiguities, inconsistencies, or inaccuracies they may find by completing the Issue Reporting Form listed on the main web page <https://www.omg.org>, under Specifications, Report a Bug/Issue.

1 Scope

The primary goal of **SCE** is to provide a set of structural elements that are common to other OMG specifications. The specification **SDMN** is structured to be dependent on the elements defined in **SCE**. Other BMI and HDTF specifications may also utilize the elements of **SCE** as they are updated in the future.

2 Conformance

SCE is not an independent specification that is implemented by itself. It is used by other specifications to provide generic capabilities that can be used by those other specifications. At the time of this writing the Shared Data Model and Notation (**SDMN**) specification is dependent on **SCE**.

Software that claims compliance or conformance to any specification that is dependent of **SCE** if and only if the software fully matches the applicable compliance points as stated in the dependent specification and this specification. Software developed only partially matching the applicable compliance points can claim only that the software was based on this specification but cannot claim compliance or conformance with this specification.

3 References

3.1 Normative References

The following normative documents contain provisions which, through reference in this text, constitute provisions of this specification. For dated references, subsequent amendments to, or revisions of, any of these publications do not apply.

- Key words for use in RFCs to Indicate Requirement Levels, S. Bradner, IETF RFC 2119, March 1997
<http://www.ietf.org/rfc/rfc2119.txt>
- [DD] Diagram Definition (DD™): <https://www.omg.org/spec/DD/>
- [MOF] Meta Object Facility (MOF™): <https://www.omg.org/spec/MOF/>
- [UML] Unified Modeling Language™ (UML®): <http://www.omg.org/spec/UML>
- [XMI] XML Metadata Interchange (XMI®) <http://www.omg.org/spec/XMI>

3.2 Non-normative References

The following normative documents contain provisions which, through reference in this text, constitute exemplars or influencers of this specification. For dated references, subsequent amendments to, or revisions of, any of these publications do not apply.

- [BPMN] Business Process and Model Notation (BPMN™): <https://www.omg.org/bpmn/>
- [CMMN] Case Management Model and Model Notation (CMMN™): <https://www.omg.org/spec/CMMN/>
- [DMN] Decision Model and Model Notation (DMN™): <https://www.omg.org/spec/DMN/>
- [MDMI] Model Driven Message Interoperability (MDMI), Version 1.0: <https://www.omg.org/spec/MDMI/>
- [SysML] Systems Modeling Language (SysML®): <http://www.omg.org/spec/SysML/>

4 Terms and Definitions

The table below presents a glossary for this specification:

Table 1: Glossary

Term	Definition
Case	A CMMN element that is a proceeding that involves actions taken regarding a subject in a particular situation to achieve a desired outcome.
DataItem	An SDMN DataItem represents a common definition and structure for the data handling elements of the other BPM+ models.
DataState	DataItems can optionally reference a DataState element, which is the state of the data contained in the DataItem. The definition of these DataStates, e.g., possible values and any specific semantic are out of scope of this specification. Therefore, SDMN adopters can use the DataState element and the SDMN extensibility capabilities to define their DataStates.
Decision	A DMN element that is the act of determining an output value (the chosen option), from a number of input values, using logic defining how the output is determined from the inputs.
Process	A BPMN element that describes a sequence or flow of Activities in an organization with the objective of carrying out work. The ProcessRef element provides a link to a Process in a BPMN document.

5 Symbols

There are no symbols defined in this specification.

6 Additional Information

6.1 Conventions

The section introduces the conventions used in this document. This includes (text) notational conventions and notations for schema components. Also included are designated namespace definitions.

6.2 Typographical and Linguistic Conventions and Style

This document incorporates the following conventions:

- The keywords “MUST,” “MUST NOT,” “REQUIRED,” “SHALL,” “MUST NOT,” “SHOULD,” “SHOULD NOT,” “RECOMMENDED,” “MAY,” and “OPTIONAL” in this document are to be interpreted as described in RFC-2119.
- A **term** is a word or phrase that has a special meaning. When a term is defined, the term name is highlighted in **bold** typeface.
- A reference to another definition, section, or specification is highlighted with underlined typeface and provides a link to the relevant location in this specification.
- A reference to a graphical element is highlighted with a bold, capitalized word (e.g., **Process**).
- A reference to a non-graphical element or SCE concept is highlighted by being italicized and (e.g., *Documentation*).
- A reference to an attribute or model association will be presented with the Courier New font (e.g., Expression).
- Non-normative examples are set off in boxes and accompanied by a brief explanation.

- XML and pseudo code is highlighted with `Courier New` typeface. Different font colors MAY be used to highlight the different components of the XML code.
- The cardinality of any content part is specified using the following operators:
 - `<none>` — exactly once
 - `[0..1]` — 0 or 1
 - `[0..*]` — 0 or more
 - `[1..*]` — 1 or more
- Attributes separated by `|` and grouped within `{ and }` — alternative values
 - `<value>` — default value
 - `<type>` — the type of the attribute

6.3 Display of Metamodel Diagrams

The metamodel presented in these sections utilizes the patterns and mechanisms that are used for the current BPM+ specifications. OMG specifications rarely display the entire metamodel of a technical specification in a single diagram. The entire metamodel would be very large, complicated, and hard to follow. Typically, a specification will present sub-sets of the overall metamodel as they apply to specific topics. For example, in the BPMN specifications there are metamodel diagrams that show the elements relating to activities or data elements. This document will follow that pattern and present sub-sets of a larger metamodel.



The metamodel diagrams are Unified Modeling Language (UML) structure diagrams. In addition to the metamodel, OMG specifications provide XML schemas which map to the metamodels. In general, it is through XML documents that BPM+ models are stored and exchanged.

Further, some of the metamodel elements are references to elements from other specifications. To clarify the owner of the metamodel element, there is a parenthesized text that identifies the model owner of that element. In addition, colors are used to support the text identification of the owner-language of that element. The colors are used as an aid to distinguish the languages but does not represent a normative aspect of the metamodels nor do they add any semantic information about the metamodels.

The table below presents examples of elements used throughout the metamodel diagrams within this specification:

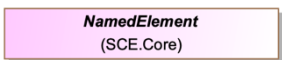
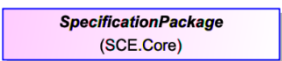
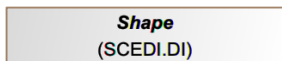
Table 2: SCE Metamodel Color-Coding

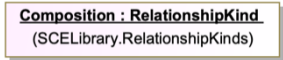
<u>Element</u>	<u>Description</u>	<u>Example Color</u>
SCE General Class	These elements include the owner of the language (SCE) in parentheses below the element name and these elements are color-coded violet to distinguish SCE classes from related BPM+ specification classes (e.g., SDMN) (see figure to the right).	
SCE General Class (focus of diagram)	These elements have the same naming and color, but the border line color is dark blue instead of light brown (see figure to the right). They are highlighted as the focus of the particular metamodel diagram. This is an informative depiction that does not add any semantic information about the particular metamodel diagram.	
External Class	Classes from specifications that are not specifically part of the BPM+ stack of standards can be included in metamodel diagrams and display the owner of the language in parentheses below the element name and these elements are color-coded light-gray. (see figure to the right).	

SCE Class Instance	These elements include the owner of the language (SCE) in parentheses below the element name and these elements are color-coded light-violet to identify SCE class instances from the SCE Library (see figure to the right).	
Enumerations	(see figure to the right).	

6.4 Use of Text, Color, Size, and Lines in a Diagram

- Diagram elements MAY have labels (e.g., its name and/or other attributes) placed inside the shape, or above or below the shape, in any direction or location, depending on the preference of the modeler or modeling tool vendor.
- The fills that are used for the graphical elements MAY be white or clear.
 - The notation MAY be extended to use other fill colors to suit the purpose of the modeler or tool (e.g., to highlight the value of an object attribute).
- Diagram elements and markers MAY be of any size that suits the purposes of the modeler or modeling tool.
- The lines that are used to draw the graphical elements MAY be black.
 - The notation MAY be extended to use other line colors to suit the purpose of the modeler or tool (e.g., to highlight the value of an object attribute).
 - The notation MAY be extended to use other line styles to suit the purpose of the modeler or tool (e.g., to highlight the value of an object attribute) with the condition that the line style MUST NOT conflict with any current defined line style of the diagram.

Note: The requirements specified in this section are specifically focused on DiagramArtifacts (see below). Any modeling specification that is dependent on SCE will define its own diagram requirements, which may override the items listed here.

6.5 Abbreviations

The table below presents a list of acronyms, and their definition, that are used in this specification:

Table 3: Acronyms

Acronym	Definition
BPM+	Business Process Management Plus
BPMN	Business Process Model and Notation
CMMN	Case Management Model and Notation
DC	Diagram Commons
DD	Diagram Definition
DI	Diagram Interchange
DMN	Decision Model and Notation
MOF	Meta Object Facility
OMG	Object Management Group
RFC	Remote Function Call
SCE	Specification Common Elements
SCEDI	Specification Common Elements Diagram Interchange
SDMN	Shared Data Model and Notation
SysML	Systems Modeling Language
URI	Uniform Resource Identifier

XMI	XML Metadata Interchange
XML	Extensible Markup Language

6.6 Structure of this Document

This document provides a brief introduction to SCE and its purpose (see the section entitled “Overview”). The introduction is followed by normative clauses that define the elements of the specification and their properties and associations (see the sections entitled “SCE Metamodel” (Clause 8); “SCE Library” (Clause 9); and “SCE Diagram Interchange” (Clause 11)).

6.7 Acknowledgements

The following companies submitted version 1.0 of this specification

- Auxilium Technology Group, LLC
- BPM Advantage Consulting, Inc.

The following companies supported this specification

- Adaptive
- agnos.ai UK Ltd
- Airbus Group
- BookZurman, Inc.
- Camunda Services GmbH
- Department of Veterans Affairs
- FICO
- Mayo Clinic
- MDIX, Inc.
- Red Hat
- Thematix Partners, LLC
- Trisotech
- University of Utah
- XZYOS, LLC

Special Acknowledgements

The following persons were members of the core teams that contributed to the content of this specification (in alphabetical order): James D. Baker, Maciej Barelkowski, Thomas Beale, Claude Baudoin, John Butler, Keith Butler, Lloyd Duggan, Denis Gagne, Eder Ignatowicz, Peter Haug, Elisa Kendall, Matteo Mortari, Falko Menge, Sean Muir, Robert Lario, Kenneth Lord, Simon Ringuette, Peter Rivett, Michael Sauvage, Keith Salzman, Jane Shellum, Davide Sottara, and Stephen A. White.

This page intentionally left blank.

7 Overview

The idea for defining a model for Specification Common Elements (**SCE**) occurred during the development of the **SDMN** specification (and other possible future specifications). These specifications were developed using patterns seen in OMG Business Modeling and Integration (BMI) Task Force, such as **BPMN** and **DMN**. **SDMN** shares a common set of elements and their attributes with these specifications. Thus, the purpose of **SCE** is to provide a set of structural elements that are common to these and other OMG specifications. **SDMN** has been structured to be dependent on the elements defined in **SCE**. Other BMI and HDTF specifications may also utilize the elements of **SCE** as they are updated in the future.

This page intentionally left blank.

8 SCE Metamodel

This section defines the semantic elements of **SCE**. The main topics are organized into **SCE Core Elements**, **Annotations**, **External Relationships**, **Internal Relationships**, **BPM+ Modeling**, and **KindSets**.

The following figure shows the organization of the **SCE** metamodel packages.

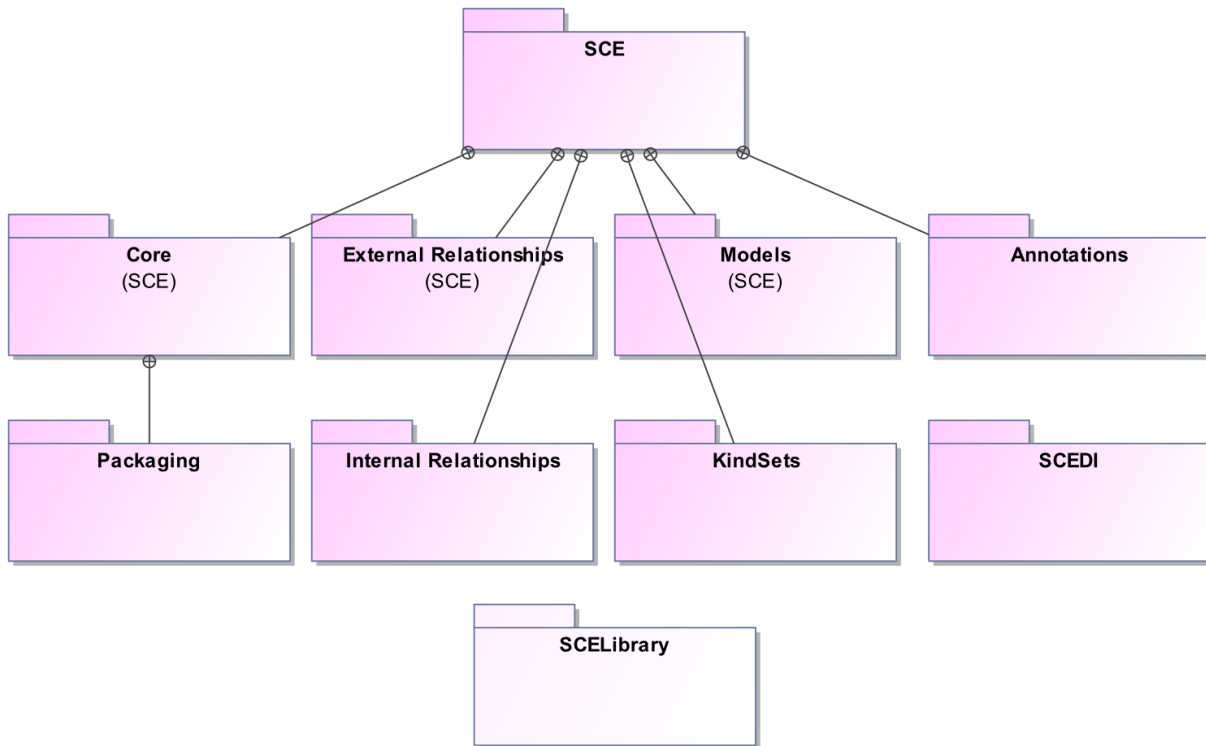

Figure 1: SCE Packages

8.1 SCE Core Elements

There is one core abstract element that make up **SCE** with a few supporting elements. The core element is: *BaseElement*. There are three elements related to the packaging of **SCE** elements (and downstream languages). These are defined in the sub-section below.

The following figure presents the **SCE** high-level metamodel, which defines the basic infrastructure elements of a **BPM+** model:

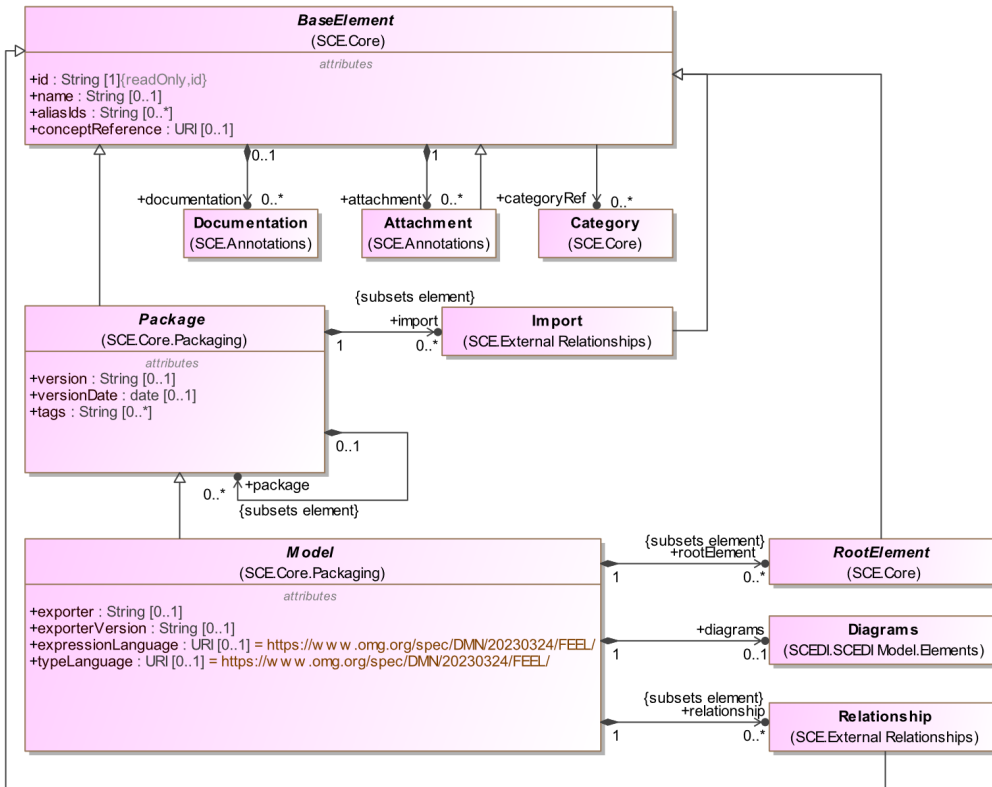

Figure 2: SCE High-Level Elements BaseElement

8.1.1 BaseElement

Most of the elements within SCE, and any specification that is dependent on SCE, will inherit the attributes and associations of *BaseElement*.

The following figure presents the metamodel for *BaseElement*:

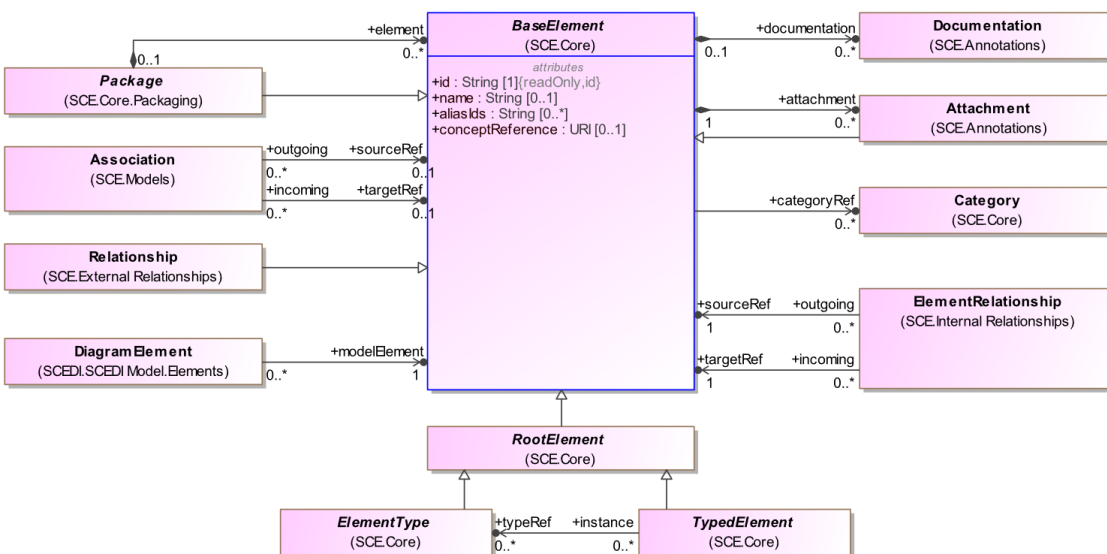

Figure 3: The BaseElement Metamodel

Generalizations

The *BaseElement* element does not inherit the attributes and/or associations of another element.

Properties

The following table presents the additional attributes and/or associations for *BaseElement*:

Table 4: BaseElement Attributes and/or Associations

Property/Association	Description
aliasIds : String [0..*]	Various optional, alternative identifiers for this <i>BaseElement</i> . Generally, these will be set by tools.
id : String [0..1]	This optional attribute is used to uniquely identify a <i>BaseElement</i> . The <code>id</code> is REQUIRED if this element is referenced or intended to be referenced by something else. If the element is not currently referenced and is never intended to be referenced, the <code>id</code> MAY be omitted.
name : String [0..1]	The <code>name</code> attribute is a text description or label of the element. In general, the name is optional, but many elements will require a name. The definition of each specialization of <i>BaseElement</i> may require name to be mandatory.
attachment : Attachment [0..*]	This association is used to annotate any concrete specialization of <i>BaseElement</i> with descriptions and other documentation.
categoryRef : Category [0..*]	This association is used to categorize any concrete specialization of <i>BaseElement</i> . A <i>Category</i> has user-defined semantics, which can be used for documentation or analysis purposes.
conceptReference : URI [0..1]	The specific context of the BPM+ elements may result in different terminology or sub-sets of data representation elements within the normative domain models. To reduce any confusion due to terminology or data representation, the BPM+ models dependent on SCE have the capability of linking model elements to the appropriate external sources of truth for their domain (i.e., a <code>conceptReference</code>). This property provides the capability of including a <code>conceptReference</code> for any <i>BaseElement</i> . It is expected that the value of the URI will be persistent.
documentation : Documentation [0..*]	This association is used to annotate any concrete specialization of <i>BaseElement</i> with descriptions and other documentation.

8.1.2 RootElement

The *RootElement* class is also a marker class for **BPM+** languages to use to include their specific model elements within their models (e.g., subclasses of the **SCE Model** class). A **BPM+** language would define its model elements as subclasses of *RootElement* and they would all be a part of the *Model* (see the *RootElement* relationship to *Model* in the figure entitled “The SCE Packaging Elements Metamodel”).

Further, in the XML schema for **SCE**, *RootElement* is also used as a substitution group for all model elements to be included in a *Model*. Thus, a **BPM+** language would not have to specific list all the elements within its version of *Model*. The language model elements would only have to be subclasses of *RootElement* and they would automatically be included in the *Model* and a specific ordering of those elements would not be required.

The following figure presents the metamodel for *RootElement*:

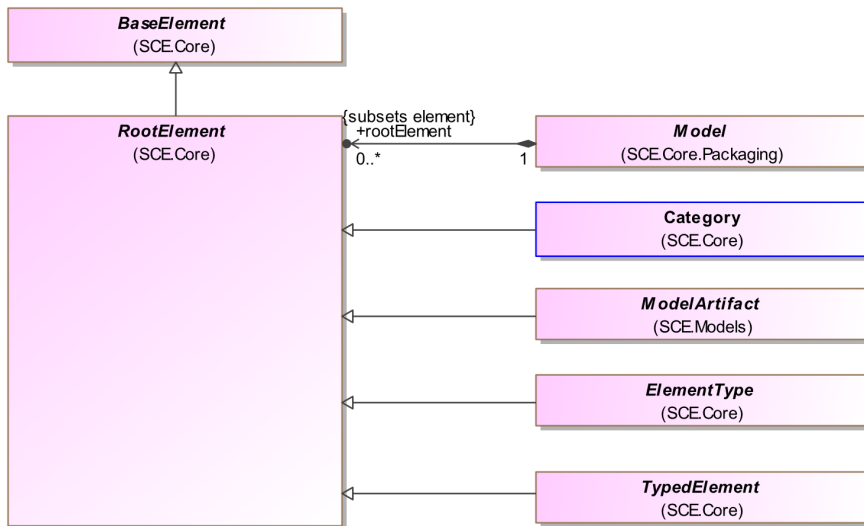

Figure 4: The RootElement Metamodel

Generalizations

The *RootElement* element inherits the attributes and/or associations of:

- *BaseElement* (see the section entitled “[BaseElement](#)” for more information).

Properties

The *RootElement* element does not have any additional attributes and/or associations.

8.1.3 ElementType

A kind of *BaseElement* (via *RootElement*) that can be a type or specification of a *TypedElement*. This usually is applied to the concrete *TypedElement* that serves as an instance in a runtime model.

An example of an *ElementType* in the context of Provenance and Pedigree would be the entity-type “Thoroughbred Horse” that is used to specific the basic characteristics of thoroughbred horses. The entity “Secretariat” (the horse), which is a *TypedElement*, is, in a sense, an “instance” of the entity-type “Thoroughbred Horse”.

Generalizations

The *ElementType* element inherits the attributes and/or associations of:

- *RootElement* (see the section entitled “[RootElement](#)” for more information).

Further, the *RootElement* element inherits the attributes and/or associations of:

- *BaseElement* (see the section entitled “[BaseElement](#)” for more information).

Properties

The *ElementType* element does not have any additional attributes and/or associations.

8.1.4 TypedElement

A kind of *BaseElement* (via *RootElement*) that has zero or more *ElementTypes*, identified by the `typeRef` attribute. The *ElementType(s)*, if present, provide a specification for the element.

An example of a *TypedElement* in the context of Provenance and Pedigree would be the entity “Secretariat” (the horse) where the entity’s pedigree is documented. The entity is a *TypedElement* since an *ElementType*, such as “Thoroughbred Horse”, can be used to specify the basic characteristics of thoroughbred horses. The specific entity “Secretariat” is, in a sense, an “instance” of the entity-type “Thoroughbred Horse”.

Generalizations

The *TypedElement* element inherits the attributes and/or associations of:

- *RootElement* (see the section entitled “RootElement” for more information).

Further, the *RootElement* element inherits the attributes and/or associations of:

- *BaseElement* (see the section entitled “BaseElement” for more information).

Properties

The following table presents the additional attributes and/or associations for *TypedElement*:

Table 5: TypedElement Attributes and/or Associations

Property/Association	Description
<code>typeRef</code> : <i>ElementType</i> [0..*]	The class(es) that provide(s) a specification, through an <i>ElementType</i> , of the <i>TypedElement</i> . This usually is applied to the concrete <i>TypedElement</i> that serves as an instance in a runtime model.

8.1.5 Category

A *Category*, which has user-defined semantics, can be used for documentation or metadata organizational purposes. For example, recommendations (in the healthcare domain) can be assigned a category of “Lifestyle Modification” with further breakdowns into “Weight Reduction,” “Exercise Program,” and “Diet Modification” sub-categories.

The following figure presents the metamodel for *Category*:

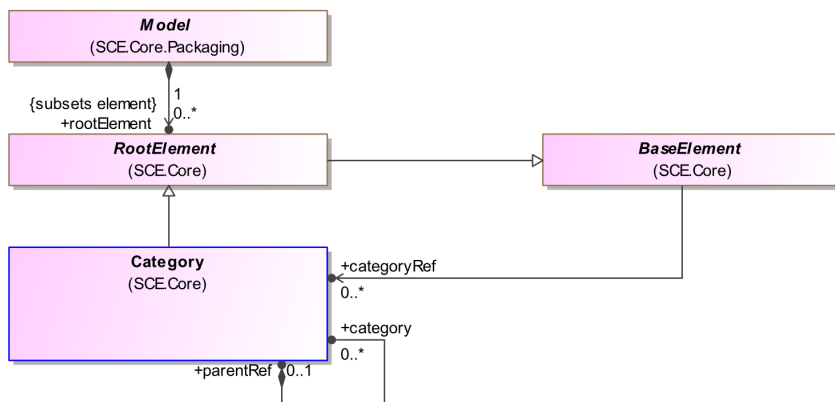

Figure 5: The Category Metamodel

The *Category* element inherits the attributes of *BaseElement* via *RootElement* and is contained within a *Model* since it is a *RootElement* (see figure above). It is referenced by any *BaseElement*. Thus, any concrete element within a model file, dependent on **SCE**, MAY have zero or more *Categories*. Further, *Categories* may be nested such that one *Category* may contain other *Categories*.

Note: The structure of Category in SCE is different than the structure of Category in BPMN. However, the two structures can be mapped to each other.

For example, in an **SDMN** diagram, *DataItems* can be categorized. The figure below shows how *DataItems* can be assigned a “Guideline Data” *Category* or a “Referrals” *Category*. In a large **SDMN** diagram, this would allow a modeler to quickly find *Data Items* of these or other *Categories*.

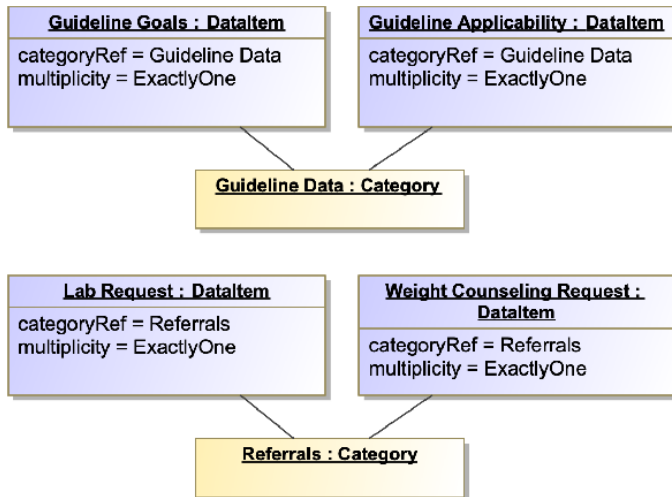

Figure 6: An Example of Groups referencing Categories (in an UML Object Diagram)

To support the categorization of model elements, *Categories* can be nested to create a hierarchy of parent and child *Categories*. For example, recommendations can be assigned a *Category* of one of the children of the “Lifestyle Modification” *Category*. As shown in the figure below, the children “Weight Reduction,” “Exercise Program,” and “Diet Modification”. Thus, these Recommendations can be organized under the parent *Category* and then further organized by the child *Categories*.

In addition, since a *Category* can reference another *Category*, the Recommendations in the figure below can be identified as being “Patient Responsibilities” through that *Category*’s association with the “Lifestyle Modification” *Category*, which is the parent of the *Category* directly associated with the Recommendation.

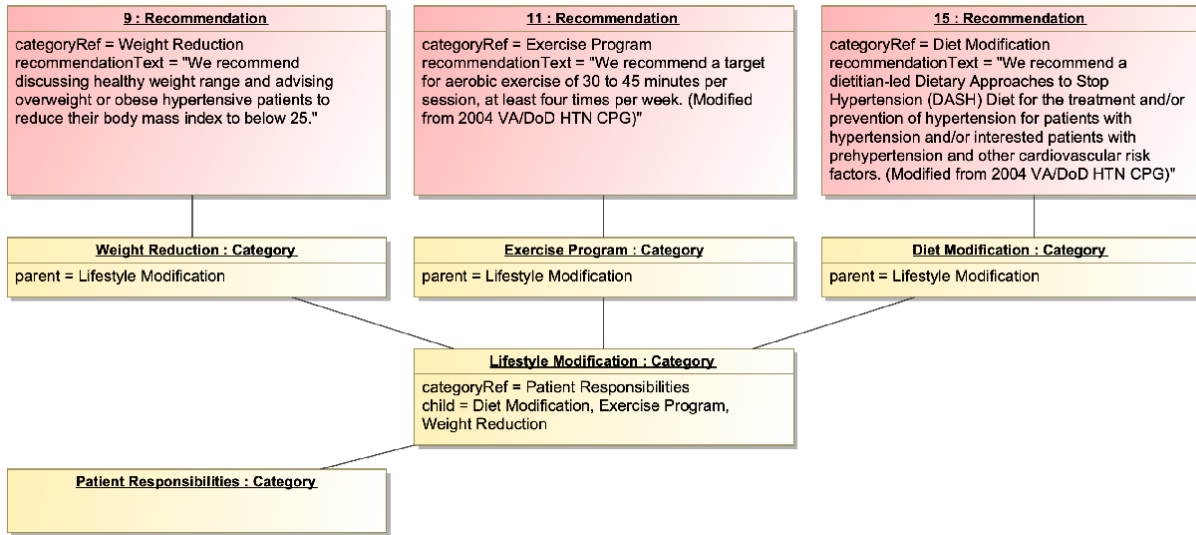

Figure 7: An Example of a Parent and Children Categories (in an UML Object Diagram)

Generalizations

The *Category* element inherits the attributes and/or associations of:

- *RootElement* (see the section entitled “RootElement” for more information).

Further, the *RootElement* element inherits the attributes and/or associations of:

- *BaseElement* (see the section entitled “BaseElement” for more information).

Properties

The following table presents the additional attributes and/or associations for *Category*:

Table 6: Category Attributes and/or Associations

Property/Association	Description
category : Category [0..*]	This association allows the nesting of <i>Categories</i> . A <i>Category</i> MAY have more than one child <i>Category</i> .
parentRef : Category [0..1]	This association allows the nesting of <i>Categories</i> . A <i>Category</i> MAY be a parent for more than one <i>Category</i> .

8.1.6 Packaging

SCE provides two elements (*Package* and *Model*) that enable the packaging and distribution of modeling languages dependent on SCE. Note that it is not expected that SCE “models” will be created and distributed, but the capabilities provided by SCE will support the creation and distribution of models created by languages utilizing SCE.

The two sub-sections below will describe the packaging elements provided by SCE.

The following figure presents the attributes and associations for the SCE *Package* and *Model* elements:

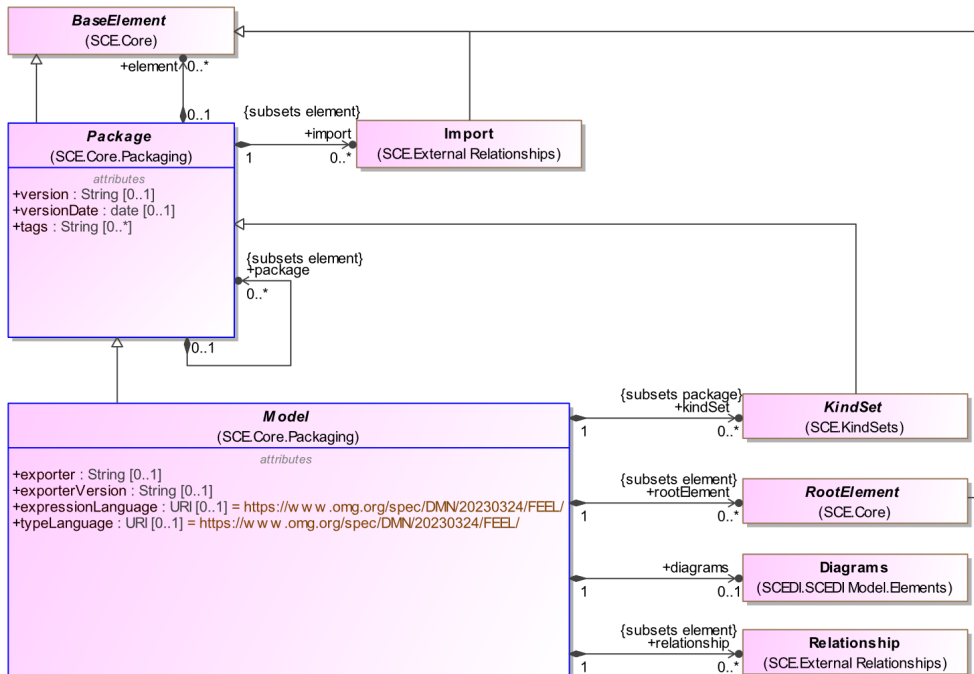

Figure 8: The SCE Packaging Elements Metamodel

8.1.6.1 Package

Package is a basic capability that is used by the other packaging classes in **SCE**. Thus, by itself it is not contained within any element. It’s sub-class, *Model*, will be used to organize the types of content that make up a model or set of models (of a language that utilizes **SCE**). The *Model* (see below) is the top-level package used for distribution of the content of a modeling language.

Note: a `targetNamespace` attribute is not required for the metamodel elements for **SCE**. However, for non-XMI XSDs, a `targetNamespace` attribute of type `anyURI` will be included in the `tPackage` type for the **SCE** XSD.

Generalizations

The *Package* element inherits the attributes and/or associations of:

- *BaseElement* (see the section entitled “[BaseElement](#)” for more information).

Properties

The following table presents the additional attributes and/or associations for *Package*:

Table 7: Package Attributes and/or Associations

Property/Association	Description
<code>package : Package [0..*]</code>	This is a list of all the sub-packages <i>Package</i> . This provides the capability for all specializations of <i>Package</i> to include sub-packages. This is a subset of the <code>element</code> association of the <i>Package</i> element.

import : Import [0..*]	This attribute is used to import externally defined elements and make them available for use by elements within a concrete specialization of an <i>Package</i> .
tags : String [0..*]	The <code>tag</code> setting provides another classification mechanism for package. This classification could be used as part of a search for a particular package within a concrete specialization of <i>Model</i> , for example.
version : String [0..1]	This attribute specifies the version of the model package that is dependent on SCE . If this attribute is specified for a package element and not specified for any of the sub-packages contained within, then the value set for the higher-level package will be assumed for the lower-level packages.
versionDate : date [0..1]	The date when the version of the model package that is dependent on SCE was established. If this attribute is specified for a package element and not specified for any of the sub-packages contained within, then the value set for the higher-level package will be assumed for the lower-level packages.

8.1.6.2 Model

This the main **SCE** package, which contains a set of properties and other elements, that are common to and usable by other modeling specifications. The idea of a “package” is that the package will contain all the elements of a model that is based on that specification. When the content of that model is serialized, the elements will be contained within a concrete specialization of *Model*. Some previous BMI specifications have named this packaging element “Definitions.” In those specifications, they had only one main package that served multiple purposes that **SCE** divided up between its sub-packages. For example, the **BPMN** *Definitions* element is the main package that contains all the Collaborations, Processes, and other elements that make up **BPMN** models, as well as holding the diagram interchange information.

The *Model* element provides the key attributes and associations that most BMI modeling specifications will need as part of their packaging element. **SCE** also provides the capability of a language to define element *instances* and model profiles. To support these additional capabilities, a set of specific sub-packages are defined. Thus, a single “Definitions” top-level package was not sufficient to support the potential languages that will utilize **SCE**.

The *Model* element inherits the attributes of *Package* (see table above). It is an abstract element; thus, **SCE** cannot be implemented by itself to create a modeling package. An implementation of another modeling specification that is dependent on **SCE** is required to produce a concrete modeling package.

Generalizations

The *Model* element inherits the attributes and/or associations of:

- *Package* (see the section entitled “[Package](#)” for more information).

Further, the *Package* element inherits the attributes and/or associations of:

- *BaseElement* (see the section entitled “[BaseElement](#)” for more information).

Properties

The following table presents the additional attributes and/or associations for *Model*:

Table 8: Model Attributes and/or Associations

Property/Association	Description
exporter : String [0..1]	This attribute identifies the tool that is exporting the model file that is dependent on SCE . If this attribute is specified for a package element and not specified for any of the sub-packages contained within, then the value set for the higher-level package will be assumed for the lower-level packages.
exporterVersion : String [0..1]	This attribute identifies the version of the tool that is exporting the file that is dependent on SCE . If this attribute is specified for a package element and not specified for any of the sub-packages contained within, then the value set for the higher-level package will be assumed for the lower-level packages.
expressionLanguage : URI [0..1] default: https://www.omg.org/spec/DMN/20230324/FEEL/	This attribute identifies the formal expression language used in Expressions within the elements of this <i>Model</i> . The default is “ https://www.omg.org/spec/DMN/20230324/FEEL/ ”. This value MAY be overridden on each individual formal Expression. The language SHALL be specified in a URI format. If any language that is based on SCE requires formal expressions, then that language will have an expression element named <i>formalExpression</i> or <i>literalExpression</i> or something similar. That element will have to include an optional property named <i>expressionLanguage</i> that, if used, will override the default property listed here for <i>Model</i> . Thus, every expression defined by that language may use a different expression language (which assumes the target engine can use that language).
relationship : Relationship [0..*]	This is a list of all the <i>Relationships</i> contained within a concrete specialization of <i>Model</i> .
kindSet : KindSet [0..*]	This is a list of terms (<i>Kinds</i>) that can be used to define the elements of a concrete specialization of <i>Model</i> .
rootElement : RootElement [0..1]	This is a list of all the <i>RootElements</i> contained within a concrete specialization of <i>Model</i> . This is a subset of the <i>element</i> association of the <i>Package</i> element.
diagrams : Diagrams [0..1]	This attribute contains the Diagram Interchange information contained within this <i>Model</i> .
typeLanguage : URI [0..1] default: https://www.omg.org/spec/DMN/20230324/FEEL/	This attribute identifies the type system used by the elements of this <i>Model</i> . The default is “ https://www.omg.org/spec/DMN/20230324/FEEL/ ”. This value can be overridden for each type usage. The language SHALL be specified in a URI format.

8.2 Annotations

Annotations allow information, provided by a modeler of a modeling language that is dependent on **SCE**, to be attached to a *BaseElement*-based element order document or categorize that element. This attached information is generally for the benefit of readers or users of the model that contains the annotated element. There are currently two concrete types of *Annotations*: *Attachments* and *Documentation*.

The following figure shows the metamodel for *Annotations*:

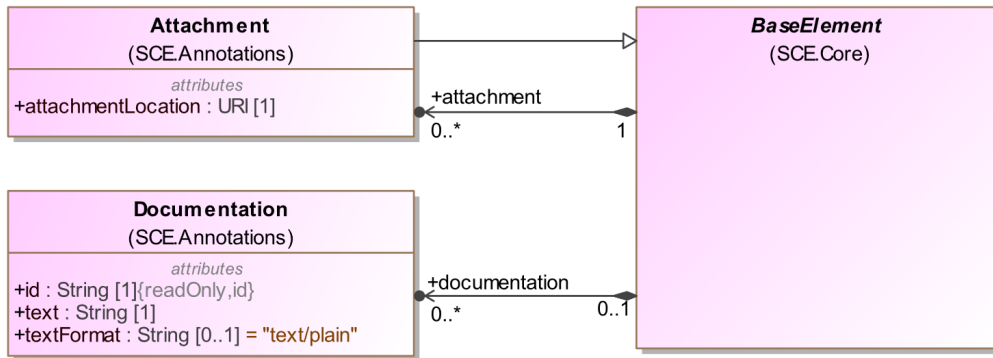

Figure 9: Annotations

8.2.1 Attachment

The *Attachment* element provides a place for model developers to provide attached documents to a model element.

The *Attachment* element is contained within a concrete specialization of *BaseElement*. Thus, any concrete element within a model that is dependent on SCE MAY have one or more *Attachments*.

Generalizations

The *Attachment* element inherits the attributes and/or associations of:

- *BaseElement* (see the section entitled “[BaseElement](#)” for more information).

Properties

The following table presents the additional attributes and/or associations for *Attachment*:

Table 9: Attachment Attributes and/or Associations

Property/Association	Description
attachmentLocation : URI [1]	This attribute identifies the URI location of the attachment.

8.2.2 Documentation

The *Documentation* element provides a place for model developers to provide descriptive information about a model element.

The *Documentation* element is contained within a concrete specialization of *BaseElement*. Thus, any concrete element within a model that is dependent on SCE MAY have one or more *Documentations*.

Generalizations

The *Documentation* element does not inherit the attributes and/or associations of another element.

Properties

The following table presents the additional attributes and/or associations for *Documentation*:

Table 10: Documentation Attributes and/or Associations

Property/Association	Description
id : String [0..1]	This optional attribute is used to uniquely identify a <i>Documentation</i> . The <i>id</i> is REQUIRED if this element is referenced or intended to be referenced by something else. If the element is not currently referenced and is never intended to be referenced, the <i>id</i> MAY be omitted.
text : String [1]	This attribute is used to capture the text descriptions of any concrete element within a model that is dependent on SCE.
textFormat : String [0..1] = "text/plain"	This attribute identifies the format of the text. It MUST follow the mime-type format. The default is "text/plain."

8.3 External Relationships

Note: the text and metamodel defined in this section are based on the External Relationships definitions found in the BPMN specification.

BPM+ models do not exist in isolation and generally participate in larger, more complex business and system development efforts. The intention of the following specification element is to enable BPM+ models to be integrated in these development efforts via the specification of a non-intrusive identity/relationship model between BPM+ models and elements expressed in any other addressable domain model.

The ‘identity/relationship’ model it is reduced to the creation of families of typed relationships that enable BPM+ and non-BPM+ Artifacts to be related in non-intrusive manner. By simply defining ‘relationship types’ that can be associated with elements in the BPM+ Artifacts and arbitrary elements in a given addressable domain model, it enables the extension and integration of BPM+ models into larger system/development efforts.

It is that these extensions will enable, for example, the linkage of ‘derivation’ or ‘definition’ relationships between UML artifacts and BPM+ Artifacts in novel ways. So, a UML use case could be related to a BPM+ element in a specification dependent on SCE without affecting the nature of the Artifacts themselves but enabling different integration models that traverse specialized relationships.

Simply, the model enables the external specification of augmentation relationships between BPM+ Artifacts and arbitrary relationship classification models. These external models, via traversing relationships declared in the external definition allow for linkages between BPM+ elements and other structured or non-structured metadata definitions.

The following figure shows the *Relationship* metamodel diagram.

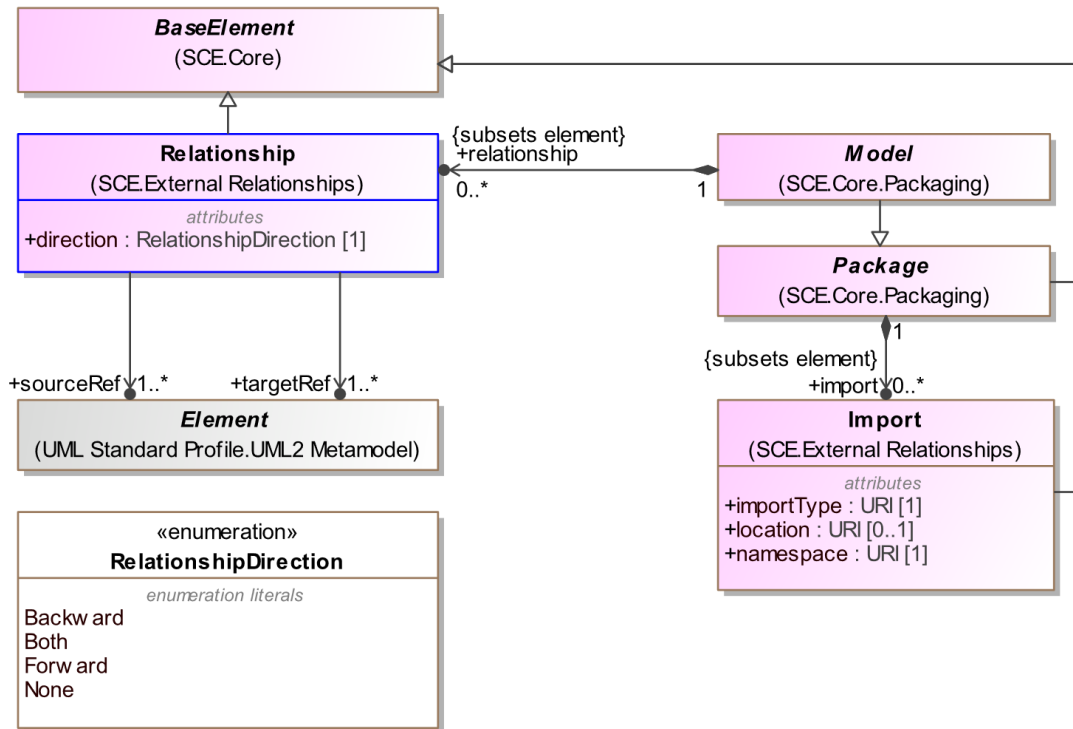

Figure 10: The External Relationships Metamodel

8.3.1 Relationship

The *Relationship* element is where an external relationship can be defined. It allows a relationship to be defined between an internal model element and an external model element. It is contained in a *Model*.

Generalizations

The *Relationship* element inherits the attributes and/or associations of:

- *BaseElement* (see the section entitled “[BaseElement](#)” for more information).

Properties

The following table presents the additional attributes and/or associations for *Relationship*:

Table 11: Relationship Attributes and/or Associations

Property/Association	Description
direction : RelationshipDirection [1]	This attribute specifies the direction of the external relationship. See the <i>RelationshipDirection</i> enumeration, below, for more details.
sourceRef : Element [1..*]	This association defines artifacts that are augmented by the external relationship.
targetRef : Element [1..*]	This association defines artifacts used to extend the semantics of the source element(s).

8.3.2 RelationshipDirection

This enumeration list specifies the direction of the relationship.

The following table lists and defines the *RelationshipDirection* literals.

Table 12: RelationshipDirection Literals

Literal	Description
Backward	This literal specifies that the <i>Relationship</i> is in the direction from the target to the source.
Both	This literal specifies that the <i>Relationship</i> is in the direction from the target to the source and from the source to the target.
Forward	This literal specifies that the <i>Relationship</i> is in the direction from the source to the target.
None	This literal specifies that the <i>Relationship</i> is in the direction from the target to the source.

8.3.3 Import

The *Import* class is used by an implementation of a modeling specification (i.e., a model), dependent on **SCE**, when referencing an external element that is contained in a different model. The referenced model can be of the same or different type of modeling specification. It is contained within a concrete specialization of *Package*.

Generalizations

The *Import* does not inherit the attributes and/or associations of another element.

Properties

The following table presents the additional attributes and/or associations for *Import*:

Table 13: Import Attributes and/or Associations

Property/Association	Description
importType : URI [1]	Identifies the type of document being imported by providing an absolute URI that identifies the encoding language used in the document, e.g. when importing XML Schema 1.0 documents the value of the <code>importType</code> attribute MUST be set to <code>http://www.w3.org/2001/XMLSchema</code> . Other types of documents MAY be supported, e.g. BPMN, CMMN, DMN or any SCE-based language.
location : string [0..1]	Identifies the location of the imported element within the document identified by the <code>importType</code> .
namespace : URI [1]	Identifies the namespace of the imported element.

8.4 Internal Relationships

The intention of the following specification element is to enable BPM+ models to develop relationships between modeling elements within a specific language. Most of these types of relationships will be specific to the context of a modeling language that is dependent on **SCE**.

The following figure presents the metamodel for *ElementRelationship* and *ElementRelationshipType* (including the predefined instance of *KindSet* for *RelationshipKind*):

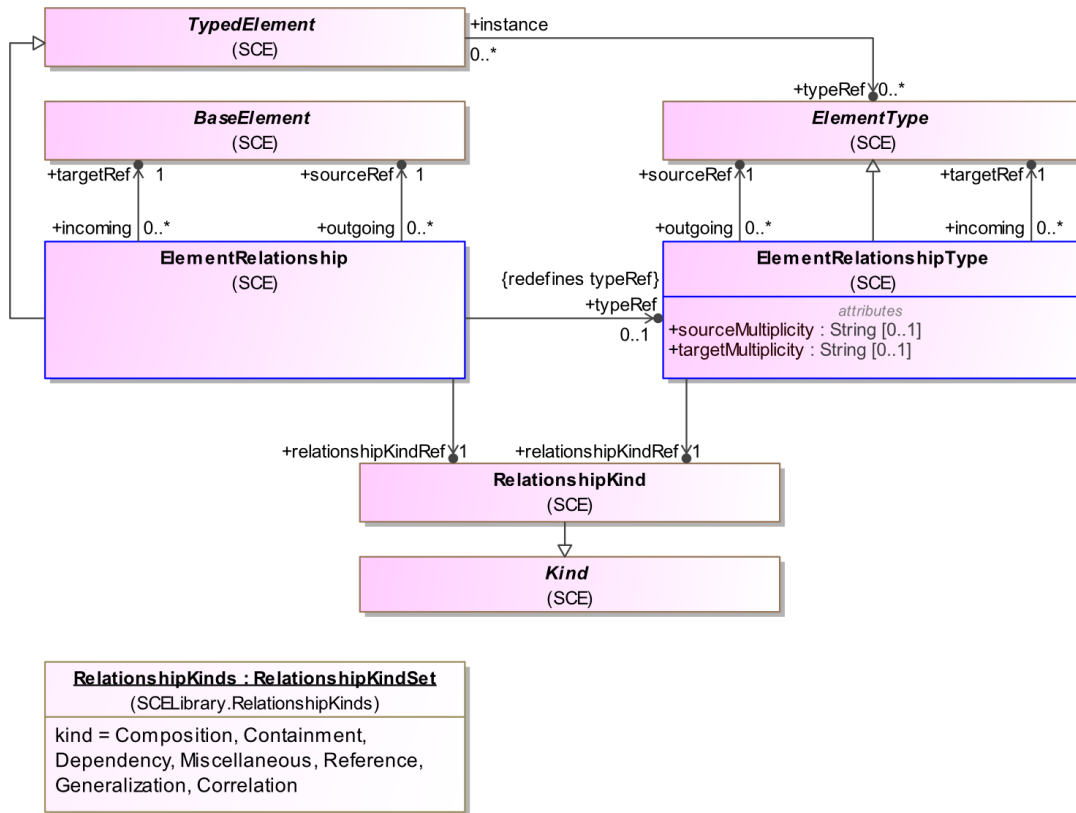

Figure 11: The Internal Relationships Metamodel

8.4.1 ElementRelationship

A kind of relationships between two *BaseElements*. The *RelationshipKind* element (see the section “*RelationshipKind*”, below for more information) identify specific types of relationships.

Generalizations

The *ElementRelationship* element inherits the attributes and/or associations of:

- *TypedElement* (see the section entitled “*TypedElement*” for more information).

Further, the *TypedElement* element inherits the attributes and/or associations of:

- *RootElement* (see the section entitled “*RootElement*” for more information).

Further, the *RootElement* element inherits the attributes and/or associations of:

- *BaseElement* (see the section entitled “*BaseElement*” for more information).

Properties

The following table presents the additional attributes and/or associations for *ElementRelationship*:

Table 14: ElementRelationship Attributes and/or Associations

Property/Association	Description
sourceRef : BaseElement [1]	The source <i>BaseElement</i> of the relationship. If there is an <i>ElementRelationshipType</i> identified through the <code>typeRef</code> association, then the source must be a <i>TypedElement</i> .
targetRef : BaseElement [1]	The target concrete specialization of <i>BaseElement</i> of the relationship. If there is an <i>ElementRelationshipType</i> identified through the <code>typeRef</code> association, then the target must be a <i>TypedElement</i> .
relationshipKindRef : RelationshipKind [1]	A description of the type of the relationship. See <i>RelationshipKind</i> , below, for more details.
typeRef : ElementRelationshipType [0..1]	The class(es) that provide(s) a specification of the <i>ElementRelationship</i> . This usually is applied to the concrete <i>ElementRelationshipType</i> that serves as an instance in a runtime model. This redefines the <code>typeRef</code> association of <i>TypedElement</i> .

8.4.2 ElementRelationshipType

A kind of *ElementRelationship* that specifies two *ElementTypes* (rather than *BaseElements*). The *RelationshipKind* element identify specific types of relationships.

Generalizations

The *ElementRelationshipType* element inherits the attributes and/or associations of:

- *ElementType* (see the section entitled “[ElementType](#)” for more information).

Further, the *ElementType* element inherits the attributes and/or associations of:

- *RootElement* (see the section entitled “[RootElement](#)” for more information).

Further, the *RootElement* element inherits the attributes and/or associations of:

- *BaseElement* (see the section entitled “[BaseElement](#)” for more information).

Properties

The following table presents the additional attributes and/or associations for *ElementRelationshipType*:

Table 15: ElementRelationshipType Attributes and/or Associations

Property/Association	Description
sourceMultiplicity : String [0..1]	This attribute defines the minimum number of source <i>BaseElements</i> that may be the source for the <i>ElementRelationship</i> that identifies this <i>ElementRelationshipType</i> through its <code>typeRef</code> association.
sourceRef : ElementType [1]	The source <i>ElementType</i> of the relationship.
targetMultiplicity : String [0..1]	This attribute defines the minimum number of target <i>BaseElements</i> that may be the source for the <i>ElementRelationship</i> that identifies this <i>ElementRelationshipType</i> through its <code>typeRef</code> association.

targetRef : ElementType [1..*]	The one or more target <i>ElementTypes</i> of the relationship.
relationshipKindRef : RelationshipKind [1]	A description of the type of the relationship. See <i>RelationshipKind</i> , below, for more details.

8.5 BPM+ Modeling

The main purpose of BPM+ modeling specifications is to provide the languages for business analysts to create specific *models* (that the language defines). For example, **BPMN** defines Process models, Collaboration models, etc; and **CMMN** defines Case models. **SCE** does not define any specific semantic element since that is the responsibility of the specific BPM+ specification. However, **SCE** provides a basic foundation for models for the modeling languages that utilize **SCE**. BPM+ Modeling languages will include, and perhaps extend, the **SCE ModelArtifacts** (see next section) within the *models* defined by those languages.

8.5.1 ModelArtifact

A *ModelArtifact* is an object that provides supporting information about a model. However, it does not have any behavioral semantics. The *ModelArtifact* element is an abstract element that inherits the attributes of *BaseElement*. *ModelArtifacts* are contained within a model type that is defined by a modeling language that extends **SCE**.

At this point, **SCE** provides three standard Artifacts: **Associations**, **Groups**, and **Text Annotations**. Additional Artifacts MAY be added to the **SCE** specification in later versions. A modeler or modeling tool MAY extend a model and add new types of *ModelArtifacts*. Any new *ModelArtifacts* MUST follow the connector connection rules defined in the modeling specification that is dependent on **SCE**. **Associations** can be used to link *ModelArtifacts* to model elements and other *ModelArtifacts*.

The following figure shows the *ModelArtifact* metamodel diagram.

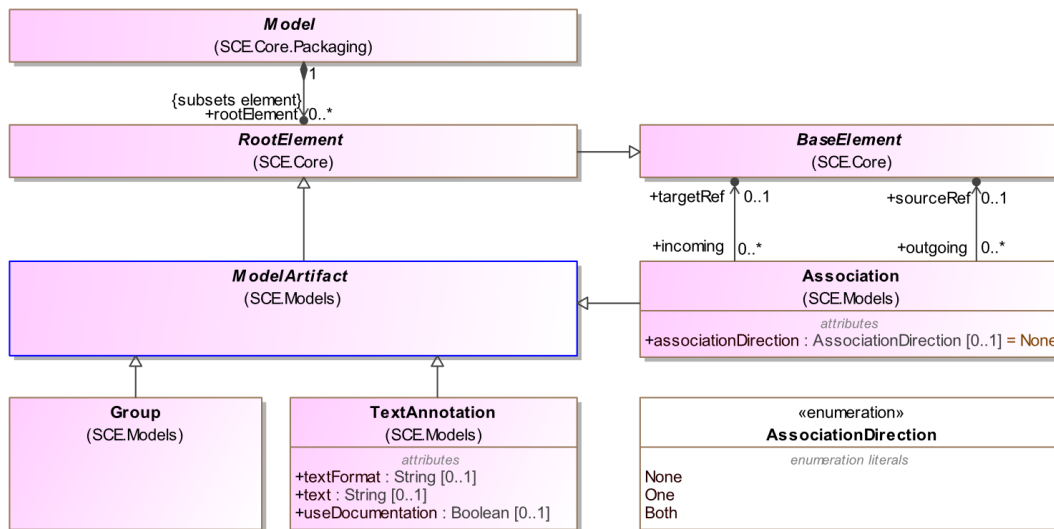

Figure 12: The ModelArtifact Metamodel

Generalizations

The *ModelArtifact* element inherits the attributes and/or associations of:

- *RootElement* (see the section entitled “RootElement” for more information).

Further, the *RootElement* element inherits the attributes and/or associations of:

- *BaseElement* (see the section entitled “[BaseElement](#)” for more information).

Properties

The *ModelArtifact* element does not have any additional attributes and/or associations.

8.5.2 Association

An **Association** is used to associate *ModelArtifacts* (often **Text Annotations**) to other diagram elements. If a *ModelArtifact* extension, such as an image, is added to the model, then that new *ModelArtifact* can be connected by an **Association**. A modeler can set the direction of the association such that the connector line will have an arrowhead on either one end or both (see figure below). The presence of one or two arrowheads does not have any specific semantic meaning but may provide a visual queue about the nature of the association.

As a *ModelArtifact*, an **Association** is contained within a model type that is defined by a modeling language that extends **SCE**.

Notation

- An **Association** is a line that **MUST** be drawn with a dotted single line (see figure below) and **MAY** have a line arrowhead, if needed.
 - The use of text, color, size, and lines for an **Association** **MUST** follow the rules defined in the section entitled “Use of Text, Color, Size, and Lines in a Diagram” on Page 4.
- If there is a reason to put directionality on the **Association**, then:
 - A line arrowhead **MAY** be added to the **Association** line (see below).
 - The directionality of the **Association** can be in one direction or in both directions.



Figure 13: An Association

An **Association** is used to connect user-defined text (a **Text Annotation**) with a diagram element (see figure below).

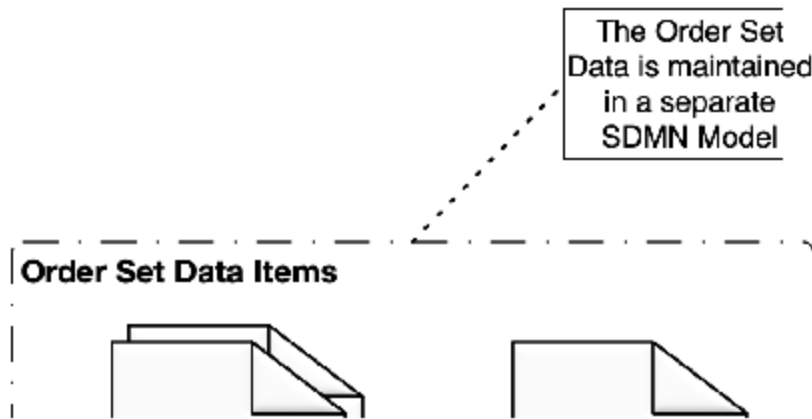

Figure 14: An Association Used with a Text Annotation

Connection Rules

The following statements define connection rules for an **Association** (when used by a modeling language dependent on SCE):

- The source of an **Association** MAY be any diagram element (either a *ModelArtifact* or the semantic diagram elements of the modeling language using the **Association**).
- The target of an **Association** MAY be any diagram element (either a *ModelArtifact* or the semantic diagram elements of the modeling language using the **Association**).

Generalizations

The **Association** element inherits the attributes and/or associations of:

- *ModelArtifact* (see the section entitled “[ModelArtifact](#)” for more information).

Further, the *ModelArtifact* element inherits the attributes and/or associations of:

- *RootElement* (see the section entitled “[RootElement](#)” for more information).

Further, the *RootElement* element inherits the attributes and/or associations of:

- *BaseElement* (see the section entitled “[BaseElement](#)” for more information).

Properties

The following table presents the additional attributes and/or associations for **Association**:

Table 16: Association Attributes and/or Associations

Property/Association	Description
associationDirection : AssociationDirection [0..1] = “None”	AssociationDirection is an attribute that defines whether or not the Association shows any directionality with an arrowhead. The default is “None” (no arrowhead). A value of “One” means that the arrowhead SHALL be at the target object. A value of “Both” means that there SHALL be an arrowhead at both ends of the Association line.

sourceRef : BaseElement [0..1]	The <i>BaseElement</i> that the Association is connecting from.
targetRef : BaseElement [0..1]	The <i>BaseElement</i> that the Association is connecting to.

8.5.3 AssociationDirection

AssociationDirection is an enumerated list that defines the options regarding whether or not an **Association** shows any directionality with an arrowhead. The default is “none” (no arrowhead). A value of “one” means that the arrowhead SHALL be at the target object. A value of “both” means that there SHALL be an arrowhead at both ends of the **Association**.

The following table lists and defines the *AssociationDirection* literals.

Table 17: AssociationDirection Literals

Literal	Description
Both	A value of “Both” means that there SHALL be an arrowhead at both ends of the Association .
None	The default is “None” (no arrowhead).
One	A value of “One” means that the arrowhead SHALL be at the <i>targetRef</i> Object.

8.5.4 Group

The **Group** object is a *ModelArtifact* that provides a mechanism to informally group elements of a model. **Groups** are often used to highlight certain sections of a model without adding additional constraints or semantics. The highlighted (grouped) section of the model can be separated for reporting and analysis purposes.

As a *ModelArtifact*, a **Group** is contained within a model type that is defined by a modeling language that extends SCE.

Notation

- A **Group** is a rounded corner rectangle that MUST be drawn with a solid dashed and dotted line (as seen in the figure below).
 - The use of text, color, size, and lines for a **Group** MUST follow the rules defined in the section entitled “Use of Text, Color, Size, and Lines in a Diagram”, above.



Figure 15: A Group

Generalizations

The **Group** element inherits the attributes and/or associations of:

- *ModelArtifact* (see the section entitled “[ModelArtifact](#)” for more information).

Further, the *ModelArtifact* element inherits the attributes and/or associations of:

- *RootElement* (see the section entitled “[RootElement](#)” for more information).

Further, the *RootElement* element inherits the attributes and/or associations of:

- *BaseElement* (see the section entitled “[BaseElement](#)” for more information).

Properties

The **Group** element does not have any additional attributes and/or associations.

8.5.5 TextAnnotation

TextAnnotations are a mechanism for a modeler to provide additional information for the reader of a model.

As a *ModelArtifact*, a **TextAnnotation** is contained within a model type that is defined by a modeling language that extends SCE.

Notation

- A **Text Annotation** is an open rectangle that **MUST** be drawn with a solid single line (as seen in Figure 16).
 - The use of text, color, size, and lines for a **Text Annotation** **MUST** follow the rules defined in the section entitled “Use of Text, Color, Size, and Lines in a Diagram”, above.
- The **Text Annotation** object can be connected to a specific object on the diagram with an **Association**.
 - The `associationDirection` of the **Association** **MUST** be “none.”

*Note that the **Association** is not required for a **Text Annotation**. That is, the **Text Annotation** can be “floating” on a diagram.*

- Text associated with the **Text Annotation** **MUST** be placed within the bounds of the open rectangle.



Figure 16: A Text Annotation

Generalizations

The **TextAnnotation** element inherits the attributes and/or associations of:

- *ModelArtifact* (see the section entitled “[ModelArtifact](#)” for more information).

Further, the *DiagramArtifact* element inherits the attributes and/or associations of:

- *RootElement* (see the section entitled “[RootElement](#)” for more information).

Further, the *RootElement* element inherits the attributes and/or associations of:

- *BaseElement* (see the section entitled “[BaseElement](#)” for more information).

Properties

The following table presents the additional attributes and/or associations for **TextAnnotation**:

Table 18: TextAnnotation Attributes and/or Associations

Property/Association	Description
text : String [0..1]	<code>text</code> is one of two attributes that provides text that the modeler wishes to communicate to the reader of the diagram. The text within a <code>text</code> is contained in and specific to the diagram where the TextAnnotation is placed. This attribute is optional, but if it used, then the <code>useDocumentation</code> attribute SHALL NOT be used.
textFormat : String [0..1] = “text/plain”	This attribute identifies the format of the text. It MUST follow the mime-type format. The default is “text/plain.” This attribute is optional, but if <code>useDocumentation</code> used, then this attribute SHALL NOT be used.
useDocumentation : boolean [0..1] = false	<code>useDocumentation</code> is one of two attributes that provides text that the modeler wishes to communicate to the reader of the model. This flag will allow a TextAnnotation to display the <i>Documentation</i> of the model element that the TextAnnotation is associated with, i.e., is connected to by an Association . This attribute is optional, but if it used, then the <code>text</code> and <code>textformat</code> attribute SHALL NOT be used. This MUST not be true if there is no Association .

8.5.6 Diagram Artifact Connection Rules

A modeling specification that is dependent on **SCE** will define connection rules that determine how *DiagramArtifacts* are used within the diagrams defined in that specification. In general, *DiagramArtifacts* are kept separate from the semantic elements and behaviors of the diagrams. **Associations** can be used to create non-semantic connections between the diagrams semantic elements and *DiagramArtifacts*.

8.6 KindSets

KindSets are *Kinds* (terms) that make up an extendable enumerated list of values for a text-based property of an element property. This capability is included in **SCE** for enumerated lists that should not be fixed by a particular version of **SCE** or a BPM+ language dependent on **SCE**.

The terms can link to formal definitions for the model elements that are created by the modeling language. The *Kind* element is used to name the term and provide a link to the definitions. *KindSets* are contained within a *Model* package. Specific *KindSets* can be established for languages utilizing **SCE** by creating sub-classes for the *KindSet* and *Kind* classes.

The following figure presents the metamodel for *KindSet*:

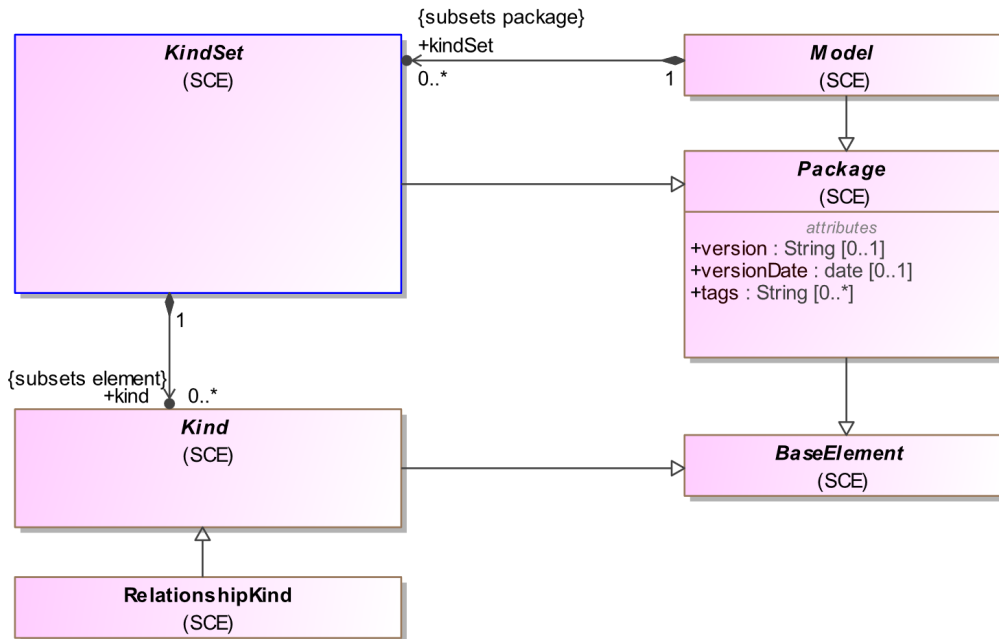

Figure 17: The KindSet Metamodel

8.6.1 KindSet

A *KindSet* is a list of terms, through the *Kind* element, that can be used to relate to model elements to the external definition or meaning. The terms themselves do not represent the definitions or meanings but provide links to an external source. Multiple *KindSets* can be defined. They are contained in a *Model*.

Further, *KindSets* can be used for creating a user-defined list of enumerated values for use within a modeling language (as opposed to a fixed enumeration list). It is up to the modeling language using **SCE** to organize the *KindSets* into the appropriate enumerated lists. Since the *Kind* element has a name and the links to external definitions are optional, the list (the “enumeration” *KindSet*) can be created before the specific external definitions are established.

SCE has one pre-defined *KindSet* for the enumerated terms for the *RelationshipKind* element (see the section entitled “[RelationshipKind](#)” for more information).

Generalizations

The *KindSet* element inherits the attributes and/or associations of:

- *Package* (see the section entitled “[Package](#)” for more information).

Further, the *Package* element inherits the attributes and/or associations of:

- *BaseElement* (see the section entitled “[BaseElement](#)” for more information).

Properties

The following table presents the additional attributes and/or associations for *KindSet*:

Table 19: RelationshipKindSet Attributes and/or Associations

Property/Association	Description
term : Kind [0..*]	The list of terms is a set of <i>Kinds</i> which can be linked to an external ontology through the <i>Kinds</i> ' <code>conceptReference</code> property.

8.6.2 Kind

A *Kind* is one of a set of *Kinds* (terms) for a *KindSet* that make up an extendable enumerated list of values for a text-based property of an element property. A *KindSet* is a list of terms, through the *Kind* element, that can be used to relate to model elements to the external definition or meaning. The terms themselves do not represent the definitions or meanings but can provide links to an external source.

Generalizations

The *Kind* element inherits the attributes and/or associations of:

- *BaseElement* (see the section entitled “[BaseElement](#)” for more information).

Properties

The *Kind* element does not have any additional attributes and/or associations.

8.6.3 RelationshipKindSet

An *RelationshipKindSet* is a list of terms, through the *RelationshipKind* element, that is used to define a set of relationship terms (the relationship between two elements in a model). The terms themselves do not represent the definitions or meanings but provide links to an external source. They are contained in a *Model*.

Further, a *RelationshipKindSet* can be used for extending the list of enumerated values in the *RelationshipKinds* Library (see below) for use within a modeling language (as opposed to a fixed enumeration list). It is up to the modeling language using **SCE** to organize the *RelationshipKindSet* into the appropriate enumerated lists. Since the *RelationshipKind* element has a name and the links to external definitions are optional, the list (the “enumeration” *RelationshipKindSet*) can be created before the specific external definitions are established.

SCE has one pre-defined *RelationshipKinds* Library for the enumerated terms for the *RelationshipKind* element (see the section entitled “[RelationshipKinds](#)” for more information).

The following figure shows the *RelationshipKindSet* metamodel diagram (which includes the standard set of instances provided by the **SCE** Library).

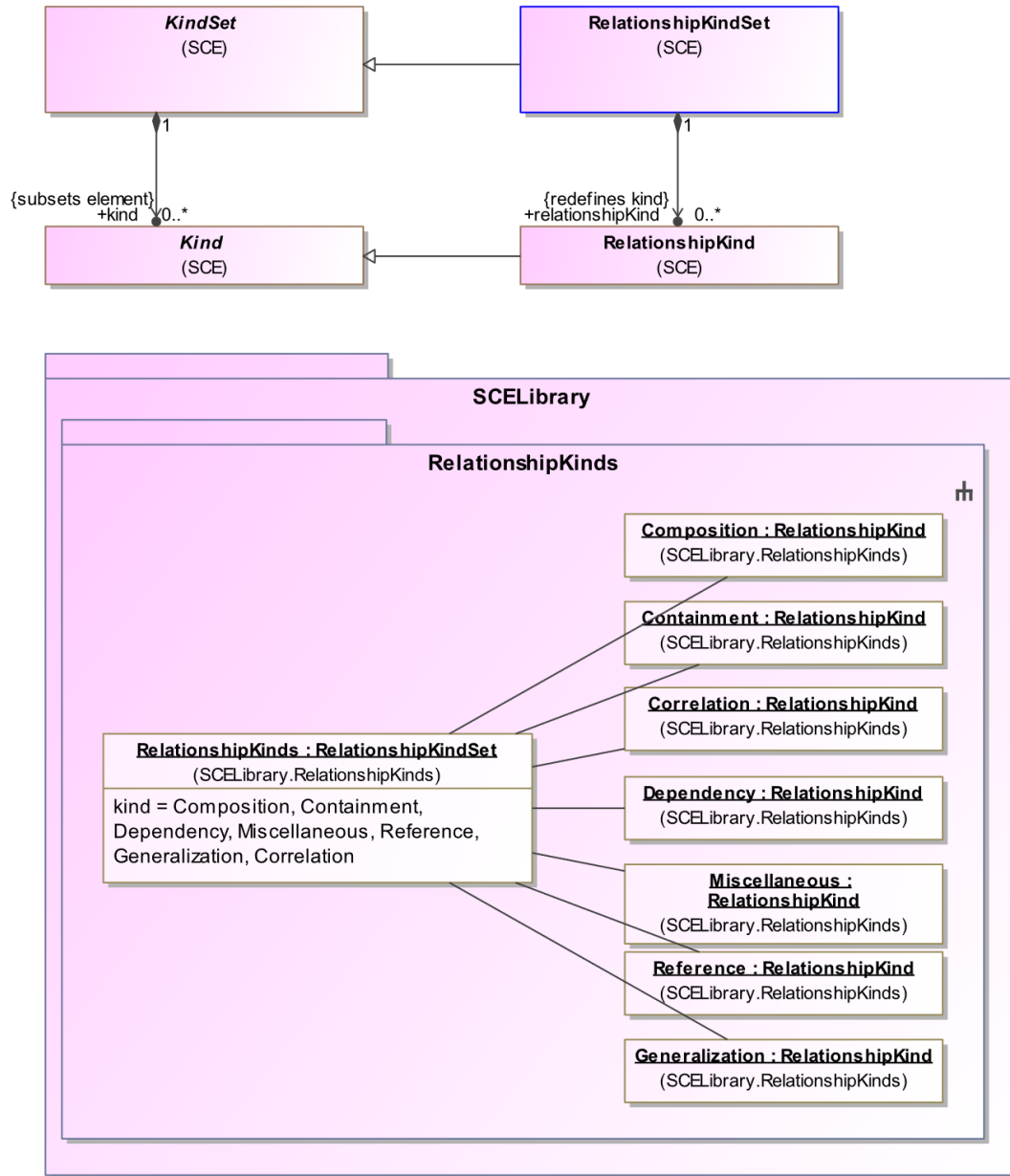

Figure 18: The RelationshipKindSet Metamodel

Generalizations

The *RelationshipKindSet* element inherits the attributes and/or associations of:

- *KindSet* (see the section entitled “KindSet” for more information).

Further, the *KindSet* element inherits the attributes and/or associations of:

- *Package* (see the section entitled “[Package](#)” for more information).

Further, the *Package* element inherits the attributes and/or associations of:

- *BaseElement* (see the section entitled “[BaseElement](#)” for more information).

Properties

The following table presents the additional attributes and/or associations for *RelationshipKindSet*:

Table 20: RelationshipKindSet Attributes and/or Associations

Property/Association	Description
relationshipKind : RelationshipKind [0..*]	The list of terms is a set of <i>RelationshipKinds</i> which can be linked to an external ontology through the <i>Kinds</i> ' <code>conceptReference</code> property.

8.6.4 RelationshipKind

This class is a type of *Kind* whose instances serve as the `terms` for a *KindSet*. A *RelationshipKind* instance is used to specify the kind of relationship that exists between two modeling elements referenced by the *ElementRelationship* and *ElementRelationshipType* elements. Instead of being defined a fixed enumerated list, the kinds can be defined through a class (*RelationshipKind*) and instances of that class (as shown below). The instances defined in the SCE Library SHALL be included in any SCE implementation. However, the implementation can allow additional instances of the class if required for a particular modeling situation (see the section entitled "[RelationshipKinds](#)" for more information).

In practice, when a modeler creates a model with a *ElementRelationship* and *ElementRelationshipType*, the *RelationshipKind* will be instantiated by one of the seven instances in the Library.

Generalizations

The *RelationshipKind* element inherits the attributes and/or associations of:

- *Kind* (see the section entitled "Kind" for more information).

Further, the *Kind* element inherits the attributes and/or associations of:

- *BaseElement* (see the section entitled "[BaseElement](#)" for more information).

Properties

The *RelationshipKind* element does not have any additional attributes and/or associations.

Standard Terms KindSet

The following table presents a description for the included instances for *RelationshipKind*:

Table 21: RelationshipKind Instances

Instance	Description
Composition	<code>Composition</code> indicates that the <code>source</code> element is composed of, in part, the <code>target</code> element. Other elements could be included in this composition.
Containment	<code>Containment</code> indicates that the <code>source</code> element is a container for the <code>target</code> element.
Correlation	<code>Correlation</code> indicates that the <code>source</code> element is correlated with the <code>target</code> element. This is often used when a mapping is required between the structures of two data elements.

Dependency	Dependency indicates that target element is dependent in some way on the source element.
Miscellaneous	Miscellaneous indicates that source element has some relationship with the target element that is of a kind that is not expressed through the other <i>RelationshipKind</i> instances.
Reference	Reference indicates that source element references the target element.
Generalization	Generalization indicates that the source element is a generalization of the target element (which is based on and extends the source).

This page intentionally left blank.

9 SCE Library

A Library is included in SCE to provide standard instances that should be implemented by tools supporting SCE through their implementing of a modeling language dependent on SCE. Currently, SCE defines the instances for one sub-package named *RelationshipKinds* (See next section).

9.1 RelationshipKinds

The *RelationshipKinds* package contains one instance of a *KindSet*: *RelationshipKinds* which is provided by the SCE Library. The purpose of this kind set is to provide a set of standard terms, which are instances of the *RelationshipKind* element.

The *RelationshipKind* element is used to specific the kind of relationship that exists between two modeling elements referenced by the *ElementRelationship* and *ElementRelationshipType* elements. Instead of defined a fixed enumerated list, the kinds can be defined through a class (*RelationshipKind*) and instances of that class (as shown below). The instances defined in this Library SHALL be included in any SCE implementation. However, the implementation can allow additional instances of the class if required for a particular modeling situation.

In practice, when a modeler creates a model with a *ElementRelationship* and *ElementRelationshipType*, the *RelationshipKind* will be instantiated by one of the six instances in this Library.

The following figure presents the instances for the *RelationshipKind* element that are terms for the instance (*RelationshipKinds*) of the *RelationshipKindSet* element:

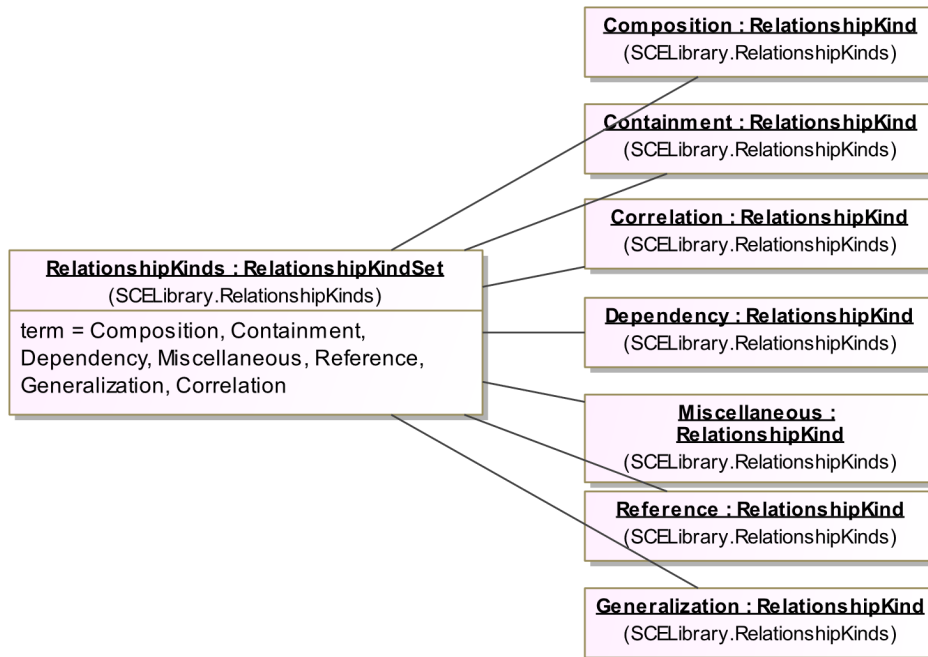

Figure 19: The RelationshipKinds Instance Model

The following table presents a description for the included instances for *RelationshipKind*:

Table 22: RelationshipKind Instances

Instance	Description
Composition	Composition indicates that the source element is composed of, in part, the target element. Other elements could be included in this composition.
Containment	Containment indicates that the source element is a container for the target element.
Correlation	Correlation indicates that the source element is correlated with the target element. This is often used when a mapping is required between the structures of two data elements.
Dependency	Dependency indicates that target element is dependent in some way on the source element.
Miscellaneous	Miscellaneous indicates that source element has some relationship with the target element that is of a kind that is not expressed through the other <i>RelationshipKind</i> instances.
Reference	Reference indicates that source element references the target element.
Generalization	Generalization indicates that the source element is a generalization of the target element (which is based on and extends the source).

10 Exchange Formats

In general, SCE models will not be interchanged independently but will be interchanged in the context of another modeling specification, such as SDMN. Thus, this section specifies characteristics of exchanging SCE models.

10.1 Interchanging Incomplete Models

In practice, it is common for models to be interchanged before they are complete. This occurs frequently when doing iterative modeling, where one user (such as a subject matter expert or businessperson) first defines a high-level model, and then passes it on to another user to be completed and refined.

Such “incomplete” models are ones in which all of the mandatory attributes have not yet been filled in, or the cardinality lowerbound of attributes and associations has not been satisfied.

XMI allows for the interchange of such incomplete models. With SCE, we extend this capability to interchange of XML files based on the SCE XSD. In such XML files, implementers are expected to support this interchange by:

- Disregarding missing attributes that are marked as ‘required’ in the XSD.
- Reducing the lower bound of elements with ‘minOccurs’ greater than 0.

10.2 XSD

10.2.1 Document Structure

A domain-specific set of model elements is interchanged in one or more SCE files. The root element of each file SHALL be an instance sub-class of *Model*. The set of files SHALL be self-contained, i.e., all definitions that are used in a file SHALL be imported directly or indirectly using the `<sce:import>` element.

Each file SHALL declare a “targetNamespace” that MAY differ between multiple files of one model.

SCE files MAY import non-SCE files (such as XSDs) if the contained elements use external definitions.

The XML namespace URIs for SCE 1.0 and backwards-compatible 1.x versions of SCE are fixed at:

- <https://www.omg.org/spec/SCE/>
- <https://www.omg.org/spec/SCE/SCEDI/>
- <https://www.omg.org/spec/SCE/DI/>
- <https://www.omg.org/spec/SCE/DC/>

In addition, the root element of SCE-based XML files MUST include an `xsi:schemaLocation` attribute that points to the concrete schema files of the versions of all namespaces, i.e. the URLs of the XSDs that are publicly hosted by OMG with dated version stamps, e.g.

```
<?xml version="1.0" encoding="UTF-8"?>
<sdmn:sharedDataModel id="HelloWorldDataModel"
  targetNamespace="https://example.org/hello-world/shared-data-model"
  xmlns="https://example.org/hello-world/shared-data-model"
  xmlns:sdmn="https://www.omg.org/spec/SDMN/"
  xmlns:sce="https://www.omg.org/spec/SCE/"
  xmlns:scedi="https://www.omg.org/spec/SCE/SCEDI/"
  xmlns:di="https://www.omg.org/spec/SCE/DI/"
  xmlns:dc="https://www.omg.org/spec/SCE/DC/"
  xmlns:xsi="http://www.w3.org/2001/XMLSchema-instance"
  xsi:schemaLocation="
    https://www.omg.org/spec/SDMN/
    https://www.omg.org/spec/SDMN/20240210/SDMN.xsd
    https://www.omg.org/spec/SCE/
```

```

    https://www.omg.org/spec/SCE/20240210/SCE.xsd
    https://www.omg.org/spec/SCE/SCEDI/
    https://www.omg.org/spec/SCE/20240210/SCEDI.xsd
    https://www.omg.org/spec/SCE/DI/
    https://www.omg.org/spec/SCE/20240210/DI.xsd
    https://www.omg.org/spec/SCE/DC/
    https://www.omg.org/spec/SCE/20240210/DC.xsd
  ">
  <sce:import name="Hello_World_Item_Definitions" location="hello-world-item-
definitions.sdmn"
    importType="https://www.omg.org/spec/SDMN/"
    namespace="https://example.org/hello-world/item-definitions"/>
  <!-- ... -->
</sdmn:sharedDataModel>

```

When importing models, tools MUST read the `xsi:schemaLocation` attribute to identify which exact versions of SCE and SCE-based languages are used in the file based on the schema URLs associated with each namespace URI. If the `xsi:schemaLocation` indicates that a newer version than the one supported by the importing tool is used in the XML file, the tool MUST report a warning to the user. Furthermore, an XML schema validation with the schema version supported by the importing tool can reveal whether or not newer language features are used in the XML file.

Unless defined otherwise, the requirement to set `xsi:schemaLocation` and the option to read it as a version identifier are inherited by SCE-based languages, e.g. SDMN.

10.2.2 References within the SCE XSD

Many SCE elements that may need to be referenced contain IDs and within the SCE XSD, references to elements are expressed via these IDs. The XSD IDREF type is the traditional mechanism for referencing by IDs, however it can only reference an element within the same file. SCE elements of type *BaseElement* support referencing by ID, across files, by utilizing QNames. A QName consists of two parts: an optional namespace prefix and a local part. When used to reference a SCE element, the local part is expected to be the id of the referenced SCE element.

11 SCE Diagram Interchange (SCE DI)

11.1 Scope

This chapter specifies the meta-model and schema for SCE Diagram Interchange (SCE DI). The SCE DI is meant to facilitate the interchange of SCE-dependent diagrams between tools rather than being used for internal diagram representation by the tools. The simplest interchange approach to ensure the unambiguous rendering of a SCE-dependent diagram was chosen for SCE DI. As such, SCE DI does not aim to preserve or interchange any “tool smarts” between the source and target tools (e.g., layout smarts, efficient styling, etc.).

SCE DI does not ascertain that the SCE-dependent diagram is syntactically or semantically correct. This version of SCE DI focuses on the interchange of *DiagramArtifacts* that can be used in any modeling language that is dependent on SCE.

11.2 Diagram Definition and Interchange

The SCE DI metamodel, similar to the SCE abstract syntax meta-model, is defined as a MOF-based meta-model. As such, its instances can be serialized and interchanged using XMI. SCE DI is also defined by an XML schema. Thus, its instances can also be serialized and interchanged using XML.

The SCE DI metamodel and schema are harmonized with the OMG Diagram Definition (DD) standard version 1.1. The referenced DD contains two main parts: the Diagram Commons (DC) and the Diagram Interchange (DI). The DC defines common types like bounds and points, while the DI provides a framework for defining domain-specific diagram models. As a domain-specific DI, SCE DI defines a few new meta-model classes that derive from the abstract classes from DI.

The focus of SCE DI is the interchange of laid out shapes and edges that constitute an SCE-dependent diagram. Each shape and edge references a particular SCE model element. The referenced SCE model elements are all part of the actual SCE model. As such, SCE DI is meant to only contain information that is neither present nor derivable, from the SCE model whenever possible. Simply put, to render an SCE-dependent diagram both the SCE DI instance(s) and the referenced SCE model are REQUIRED.

From the SCE DI perspective, an SCE-dependent diagram is a particular snapshot of an SCE model at a certain point in time. Multiple SCE-dependent diagrams can be exchanged referencing model elements from the same SCE model. Each diagram may provide an incomplete or partial depiction of the content of the SCE model. As described in clause 10, an SCE model package consists of one or more files. Each file may contain any number of SCE-dependent diagrams. The exporting tool is free to decide how many diagrams are exported and the importing tool is free to decide if and how to present the contained diagrams to the user.

11.3 SCE Diagram Interchange Meta-Model

11.3.1 How to read this chapter

Clause 11.3.4 describes in detail the meta-model used to keep the layout and the look of SCE-dependent Diagrams. Clause 11.4 presents in tables a library of the SCE element depictions and an unambiguous resolution between a referenced SCE model element and its depiction.

11.3.2 Overview

The SCE DI is an instance of the OMG DI meta-model. The basic concept of SCE DI, as with diagram interchange in general, is that serializing a diagram [*Diagram*] for interchange requires the specification of a collection of shapes [*Shape*] and edges [*Edge*].

The SCE DI classes only define the visual properties used for depiction. All other properties that are REQUIRED for the unambiguous depiction of the SCE element are derived from the referenced SCE element [*ElementRef*].

SCE-dependent diagrams may be an incomplete or partial depiction of the content of the SCE model. Some SCE elements from a SCE model may not be present in any of the diagram instances being interchanged.

SCE DI does not directly provide for any containment concept. The *Diagram* is an ordered collection of mixed *Shape(s)* and *Edge(s)*. The order of the *Shape(s)* and *Edge(s)* inside a *Diagram* determines their Z-order (i.e., what is in front of what). *Shape(s)* and *Edge(s)* that are meant to be depicted “on top” of other *Shape(s)* and *Edge(s)* **MUST** appear after them in the *Diagram*. Thus, the exporting tool **MUST** order all *Shape(s)* and *Edge(s)* such that the desired depiction can be rendered.

11.3.3 Measurement Unit

As per OMG DD, all coordinates and lengths defined by **SCEDI** are assumed to be in user units, except when specified otherwise. A user unit is a value in the user coordinate system, which initially (before any transformation is applied) aligns with the device’s coordinate system (for example, a pixel grid of a display). A user unit, therefore, represents a logical rather than physical measurement unit. Since some applications might specify a physical dimension for a diagram as well (mainly for printing purposes), a mapping from a user unit to a physical unit can be specified as a diagram’s resolution. Inch is chosen in this specification to avoid variability, but tools can easily convert from/to other preferred physical units. Resolution specifies how many user units fit within one physical unit (for example, a resolution of 300 specifies that 300 user units fit within 1 inch on the device).

11.3.4 Elements

The following sections define the elements necessary for exchanging the diagrams from BPM+ modeling languages that are dependent on **SCE**. Specifically, the graphical *DiagramArtifacts* that may be used in the diagram.

11.3.4.1 Diagrams

The class *Diagrams* is a container for the shared *Style* and all the *Diagram* defined in an **SCE**-dependent modeling package.

The following figure shows the *SCEDI* metamodel diagram.

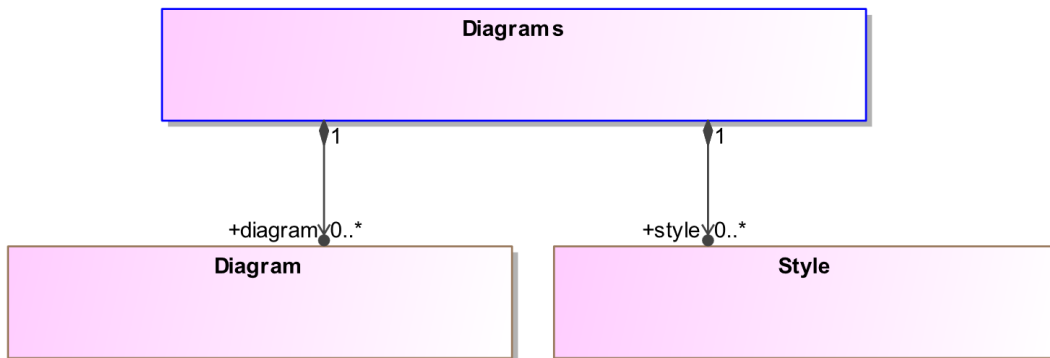

Figure 20: The Diagrams Metamodel

Generalizations

The *Diagrams* element does not inherit any attributes or associations of from another element.

Properties

The following table presents the additional attributes and/or associations for *Diagrams*:

Table 23: Diagrams Attributes and/or Associations

Property/Association	Description
diagram : Diagram [0..*]	A list of <i>Diagrams</i> .
style : Style [0..*]	A list of shared <i>Style</i> that can be referenced by all SCE-dependent diagrams and <i>DiagramElement</i> .

11.3.4.2 Diagram

The class *Diagram* specializes *DI::Diagram*. It is a kind of *Diagram* that represents a depiction of all or part of a SCE-dependent model. It is contained within the *SCEDI* element (see above). The languages that are dependent on SCE will this class.

Diagram is the container of *DiagramElement* (*Shape*(s) and *Edge*(s)). *Diagram* cannot include other *Diagrams*.

A *Diagram* can define a *Style* locally and/or it can refer to a shared one defined in the *SCEDI*. Properties defined in the local style overrides the one in the referenced shared style. That combined style (shared and local) is the default style for all the *DiagramElement* contained in this *Diagram*.

The *Diagram* class represents a two-dimensional surface with an origin of (0, 0) at the top left corner. This means that the x and y axes have increasing coordinates to the right and bottom. Only positive coordinates are allowed for diagram elements that are nested in a *Diagram*.

The following figure shows the *Diagram* metamodel diagram.

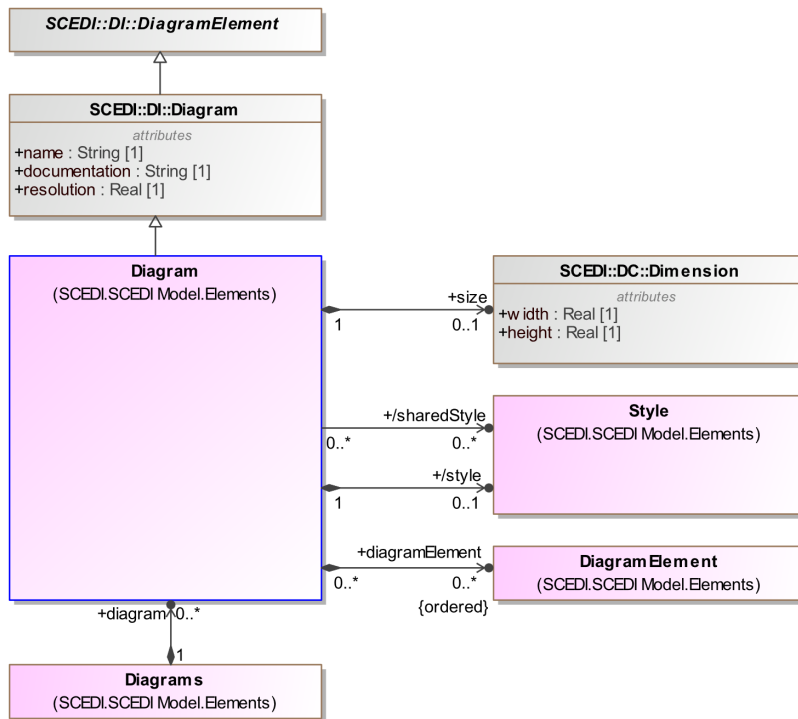

Figure 21: The Diagram Metamodel

Generalizations

The *Diagram* element inherits the attributes and/or associations of:

- *Diagram* (see the section entitled “[Diagram](#)” for more information).

Further, the *Diagram* element inherits the attributes and/or associations of:

- *DiagramElement* (see the section entitled “[DiagramElement](#)” for more information).

Properties

The following table presents the additional attributes and/or associations for *Diagram*:

Table 24: Diagram Attributes and/or Associations

Property/Association	Description
diagramElement : DiagramElement [0..*]	A list of <i>DiagramElements</i> (<i>Shape</i> and <i>Edge</i>) that are depicted in the SCE-dependent diagram.
style : Style [0..1]	A <i>Style</i> that defines the default styling for this diagram. Properties defined in that style override the ones in the <code>sharedStyle</code> .
sharedStyle : Style [0..*]	A reference to a <i>Style</i> defined in the SCEDI that serves as the default styling of the <i>DiagramElement</i> in the SCE-dependent diagram.
size : DC:Dimension [0..1]	The size of this diagram. If not specified, the the SCE-dependent diagram is unbounded.

11.3.4.3 DiagramElement

The *DiagramElement* class is contained by the *Diagram* and is the base class for *Shape* and *Edge*.

DiagramElement inherits its styling from its parent *Diagram*. In addition, it can refer to one of the shared *Style* defined in the SCEDI and/or it can define a local style. See section below for more details on styling.

DiagramElement MAY also contain a *Label* when it has a visible text label. If no *Label* is defined, the *DiagramElement* should be depicted without a label.

The following figure shows the *DiagramElement* metamodel diagram.

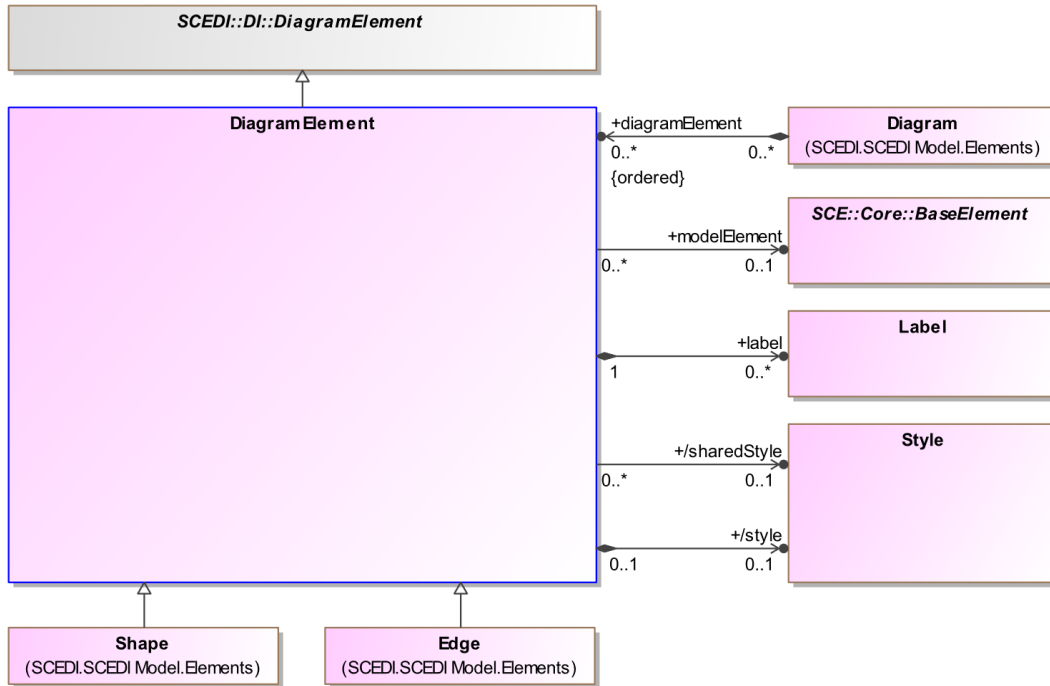

Figure 22: The DiagramElement Metamodel

Generalizations

The *DiagramElement* element inherits the attributes and/or associations of:

- *DiagramElement* (see the section entitled “[DiagramElement](#)” for more information).

Properties

The following table presents the additional attributes and/or associations for *DiagramElement*:

Table 25: DiagramElement Attributes and/or Associations

Property/Association	Description
label : Label [0..*]	An optional label when the SCE-dependent Element has a visible text label.
style : Style [0..1]	A <i>Style</i> that defines the styling for this element.
modelElement : BaseElement [0..1]	A reference to the concrete instance of the <i>BaseElement</i> that is being depicted.
sharedStyle : Style [0..1]	A reference to a <i>Style</i> defined in the <i>SCEDI</i> .

11.3.4.4 Shape

The *Shape* class specializes *DI::Shape* and *DiagramElement*. It is a kind of *Shape* that depicts an *Element* from the SCE-dependent model.

Shape represents a **Group** or a **Text Annotation** that is depicted on the diagram. SCE-dependent models may add additional shapes to their diagrams.

Shape has no additional properties, but an SCE-dependent model may extend this class to add properties that are used to further specify the appearance of some shapes that cannot be deduced from the SCE-dependent model.

The following figure shows the *Shape* metamodel diagram.

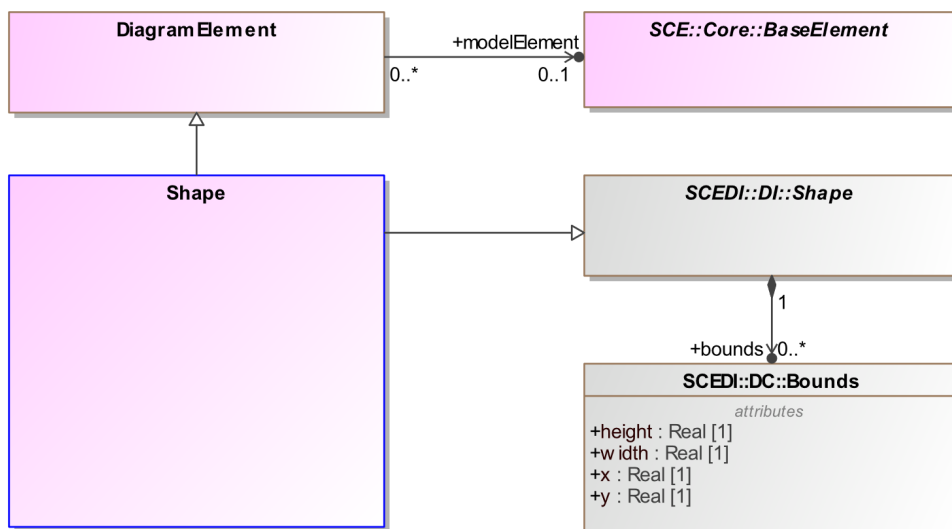

Figure 23: The Shape Metamodel

Generalizations

The *Shape* element inherits the attributes and/or associations of:

- *DiagramElement* (see the section entitled “[DiagramElement](#)” for more information).

Further, the *DiagramElement* element inherits the attributes and/or associations of:

- *DiagramElement* (see the section entitled “[DiagramElement](#)” for more information).

In addition, the *Shape* element inherits the attributes and/or associations of:

- *Shape* (see the section entitled “[Shape](#)” for more information).

Properties

The *Shape* element does not have any additional attributes and/or associations.

11.3.4.5 Edge

The *Edge* class specializes *DI::Edge* and *DiagramElement*. It is a kind of *Edge* that can depict a relationship between two SCE-dependent model elements.

Edge is used to depict **Associations** in the SCE-dependent model. Since *DiagramElement* might be depicted more than once, *sourceElement* and *targetElement* attributes allow to determine to which depiction an *Edge* is connected. When *Edge* has a source, its *sourceModelElement* MUST refer to the *DiagramElement* it starts from. That *DiagramElement* MUST be resolved to the *Element* that is the actual source of the **Association**. When it has a target, its *targetModelElement* MUST refer to the *DiagramElement* where it ends. That *DiagramElement* MUST be resolved to the *BaseElement* that is the actual target of the **Association**.

The following figure shows the *Edge* metamodel diagram.

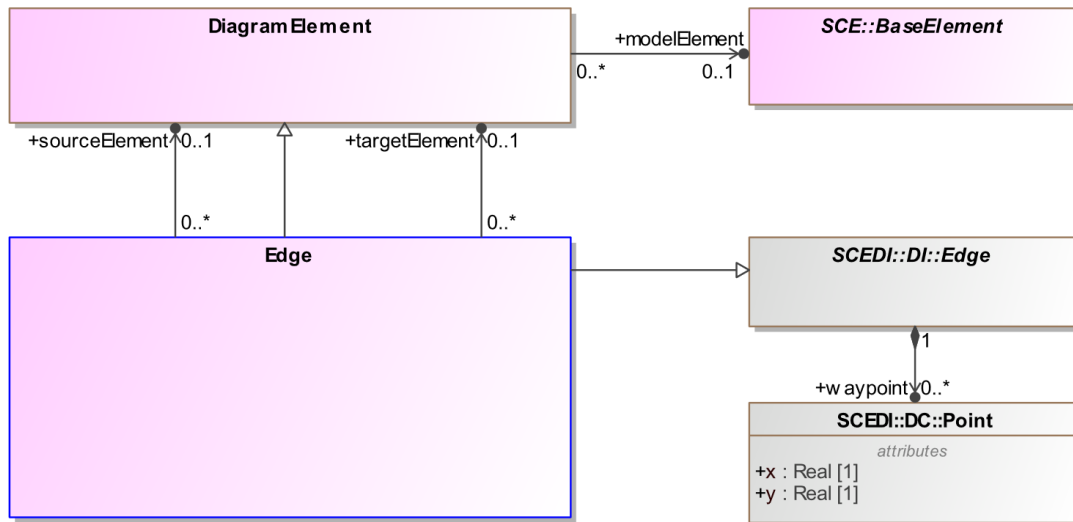

Figure 24: The Edge Metamodel

Generalizations

The *Edge* element inherits the attributes and/or associations of:

- *Edge* (see the section entitled “[Edge](#)” for more information).

In addition, the *Edge* element inherits the attributes and/or associations of:

- *DiagramElement* (see the section entitled “[DiagramElement](#)” for more information).

Further, the *DiagramElement* element inherits the attributes and/or associations of:

- *DiagramElement* (see the section entitled “[DiagramElement](#)” for more information).

Properties

The following table presents the additional attributes and/or associations for *Edge*:

Table 26: Edge Attributes and/or Associations

Property/Association	Description
sourceElement : DiagramElement [0..1]	An optional reference to the DiagramElement that this Edge starts from. This attribute MUST ONLY be present if the Edge is depicted starting from a different source than the one referenced by the modelElement of the Edge (from DI:Edge).
targetElement : DiagramElement [0..1]	An optional reference to the DiagramElement that this Edge starts from. This attribute MUST ONLY be present if the Edge is depicted ending at a different target than the one referenced by the modelElement of the Edge (from DI:Edge).

11.3.4.6 Label

Label represents the depiction of some textual information about an element.

A *Label* is not a top-level element but is always nested inside either a *Shape* or an *Edge*. It does not have its own reference to a **SCE** element but rather inherits that reference from its parent *Shape*. The textual information depicted by the label is derived from the name attribute of the referenced *BaseElement*.

The following figure shows the *Label* metamodel diagram.

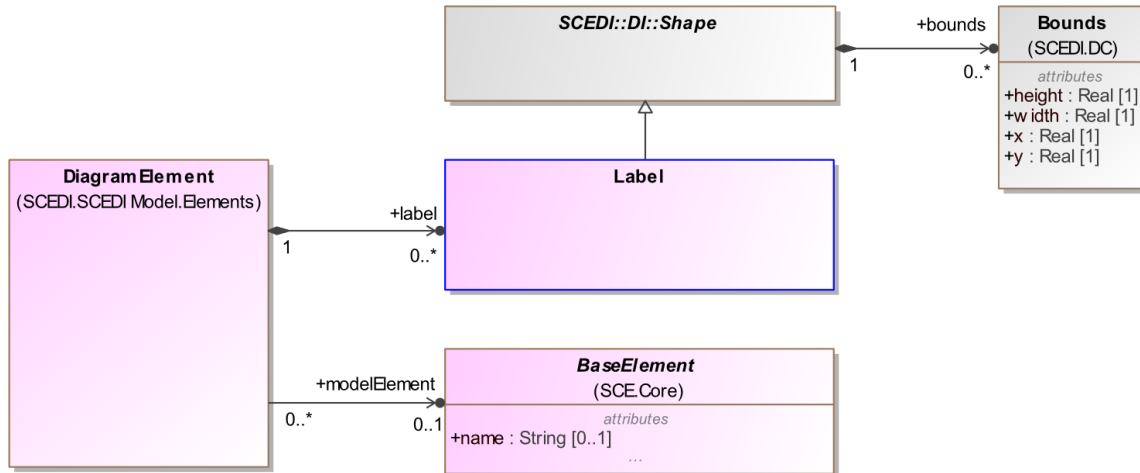

Figure 25: The Label Metamodel

Generalizations

The *Label* element inherits the attributes and/or associations of:

- *Shape* (see the section entitled “[Shape](#)” for more information).

Properties

The *Label* element does not have any additional attributes and/or associations.

11.3.4.7 Style

Style specializes `DC::Style`. It is a kind of style that provides appearance options for a *DiagramElement*.

Style is used to keep some non-normative visual attributes such as colors and font. **SCE** doesn’t give any semantic to color and font styling, but tools can decide to use them and interchange them.

DiagramElement style is calculated by percolating up *Style* attributes defined at a different level of the hierarchy. Each attribute is considered independently (meaning that a *Style* attribute can be individually overloaded). The precedence rules are as follow:

- The *Style* defined by the `style` attribute of the *DiagramElement*
- The *Style* referenced by the `sharedStyle` attribute of the *DiagramElement*
- The *Style* defined by the `style` attribute of the parent *Diagram*
- The *Style* referenced by the `sharedStyle` attribute of the parent *Diagram*

The default attribute value defined in *Style* attributes.

For example, let’s say we have the following:

- *DiagramElement* has a local *Style* that specifies the `fillColor` and `strokeColor`
- Its parent *Diagram* defines a local *Style* that specifies the `fillColor` and `fontColor`

Then the resulting *DiagramElement* should use:

- The `fillColor` and `strokeColor` defined at the *DiagramElement* level (as they are defined locally).
- The `fontColor` defined at the *Diagram* level (as the `fillColor` was overloaded locally).
- All other *Style* attributes would have their default values.

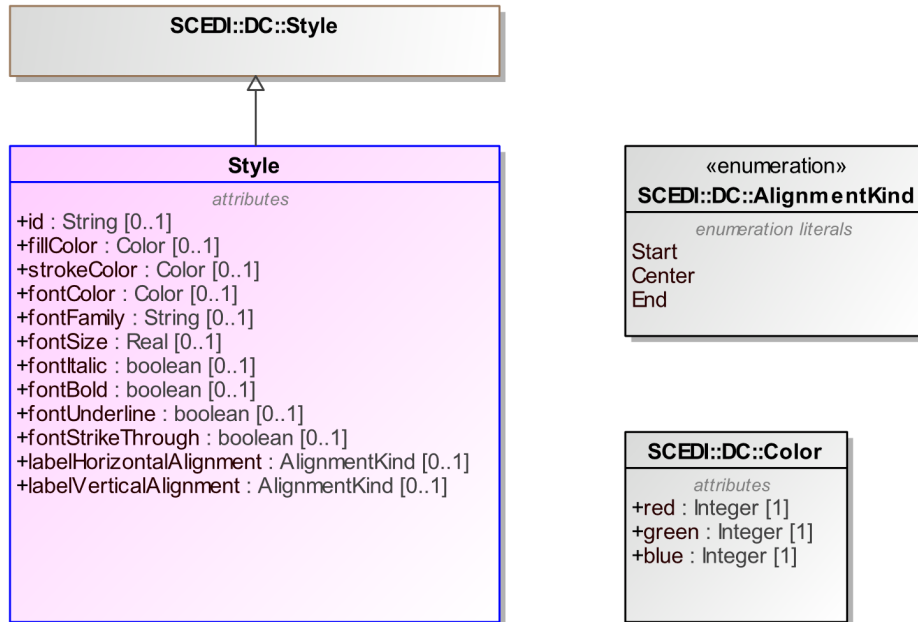

Figure 26: The Style Metamodel

Generalizations

The *Style* element inherits the attributes and/or associations of:

- *Style* (see the section entitled “[Style](#)” for more information).

Properties

The following table presents the additional attributes and/or associations for *Style*:

Table 27: Style Attributes and/or Associations

Property/Association	Description
fillColor : Color [0..1]	The color use to fill the shape. Doesn’t apply to <i>Edge</i> . The default is <code>white</code> .
fontBold : boolean [0..1]	If the text should be displayed in Bold. The default is <code>false</code> .
fontColor : Color [0..1]	The color use to write the label. The default is <code>black</code> .
fontFamily : String [0..1]	A comma-separated list of Font Name that can be used to display the text. The default is <code>Arial</code> .
fontItalic : boolean [0..1]	If the text should be displayed in Italic. The default is <code>false</code> .
fontSize : Real [0..1]	The size in points of the font to use to display the text. The default is <code>8</code> .
fontStrikeThrough : boolean [0..1]	If the text should be stroke through. The default is <code>false</code> .

fontUnderline : boolean [0..1]	If the text should be underlined. The default is <i>false</i> .
id : String [0..1]	A unique id for this style so it can be referenced. Only styles defined in the SCEDI can be referenced by <i>DiagramElement</i> and <i>Diagram</i> .
labelHorizontalAlignment : AlignmentKind [0..1]	How text should be positioned horizontally within the Label bounds. Default depends of the <i>DiagramElement</i> the label is attached to (see section below).
labelVerticalAlignment : AlignmentKind [0..1]	How the text should be positioned vertically inside the Label bounds. Default depends of the <i>DiagramElement</i> the label is attached to (see section below). Start means “top” and end means “bottom”.
strokeColor : Color [0..1]	The color use to draw the shape borders. The default is <i>black</i> .

11.4 Notation

As a specification that contains notation, **SCE** specifies the depiction for **SCE** *DiagramArtifact* elements.

Serializing an **SCE** diagram for interchange requires the specification of a collection of *Shape(s)* and *Edge(s)* in the *Diagram* (see sections above). The *Shape(s)* and *Edge(s)* attributes must be populated in such a way as to allow the unambiguous rendering of the **SCE**-dependent diagram by the receiving party. More specifically, the *Shape(s)* and *Edge(s)* **MUST** reference **SCE** model elements. If no *Element* is referenced or if the reference is invalid, it is expected that this shape or edge should not be depicted.

When rendering an **SCE**-dependent diagram, the correct depiction of a *Shape* or *Edge* depends mainly on the referenced **SCE** model element and its particular attributes and/or references. The purpose of this clause is to: provide a library of the **SCE** element depictions, and to provide an unambiguous resolution between the referenced **SCE** model element [*Element*] and their depiction. Depiction resolution tables are provided below for both *Shape* and *Edge*.

11.4.1 Labels

Both *Shape* and *Edge* may have labels (its name attribute) placed on the shape/edge, or above or below the shape/edge, in any direction or location, depending on the preference of the modeler or modeling tool vendor.

Labels are optional for *Shape* and *Edge*. When there is a label, the position of the label is specified by the bounds of the *Label* of the *Shape* or *Edge*. Simply put, label visibility is defined by the presence of the *Label* element.

The bounds of the *Label* are optional and always relative to the containing *Diagram's* origin point. The depiction resolution tables provided below exemplify default label positions if no bounds are provided for the *Label* (for *Shape* kinds and *Edge* kinds (see sections above)).

When the *Label* is contained in a *Shape*, the text to display is the name of the *BaseElement*.

11.4.2 Shape Resolution



Shape can be used to represent a **Text Annotation** or a **Group**.

11.4.2.1 Diagram Artifacts

The **Association** element is included in the **SCE** metamodel as a *DiagramArtifact*. However, its notation is rendered through an *Edge* (see section below).

The following table presents the depiction resolutions for *DiagramArtifacts*:

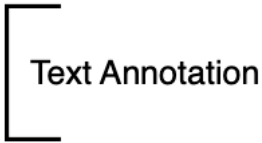
Table 28: Depiction Resolution of DiagramArtifacts

SCE Element	Depiction
TextAnnotation	
Group	

11.4.3 Edge Resolution

Edge can be used to represent an **Association**.

11.4.3.1 Association

Although an **Association** is placed in the SCE metamodel as a *DiagramArtifact*, its notation will be rendered with a *Edge*. When the *Edge* depicts an **Association**, its *BaseElement* MUST be specified.

The following table presents the depiction resolutions for an **Association**:

Table 29: Depiction Resolution of Association

SCE Element	Depiction
Association where associationDirection is none.	-----
Association where associationDirection is one.	----->
Association where associationDirection is both.	<----->

This page intentionally left blank.

Annex A: Mapping to BPMN

The elements of **SCE** are not current available for use by **BPMN**. At some point, the **BPMN** specifications may be updated to enable their utilization of **SCE** elements. As mentioned above, the design and structure of **SCE** is based on the design and structure of **BPM+** specifications like **BPMN**. However, there are some differences and additions to **SCE** when compared to the **BPMN**. If there is not an exact match between an element in **BPMN** and a corresponding element in **SCE**, then a mapping will be defined.

Table 30: Mapping to/from BPMN Base Element/Root Element

BPMN Element/Property	SCE Element/Property
BaseElement	<i>BaseElement</i>
BaseElement.id	<i>BaseElement.id</i>
Not used in BPMN BaseElement. The name property is included in specific BPMN elements that may have a name.	<i>BaseElement.name</i>
Not included in BPMN .	<i>BaseElement.aliasIds</i>
RootElement (extends BaseElement with no additional properties)	<i>RootElement</i>

Table 31: Mapping to/from BPMN Definitions

BPMN Element/Property	SCE Element/Property
Definitions	<i>Model</i>
Definitions.name	See <i>BaseElement.name</i>
Definitions.targetNamespace	<i>Model.targetNamespace</i>
Definitions.expressionLanguage	<i>Model.expressionLanguage</i>
Definitions.typeLanguage	<i>Model.typeLanguage</i>
Definitions.exporter	<i>Model.exporter</i>
Definitions.exporterVersion	<i>Model.exporterVersion</i>
Not included in BPMN	<i>Package.tags</i>
Not included in BPMN	<i>Package.version</i>
Not included in BPMN	<i>Package.versionDate</i>

This page intentionally left blank.

Annex B: Mapping to CMMN

The elements of **SCE** are not currently available for use by **CMMN**. At some point, the **CMMN** specifications may be updated to enable their utilization of **SCE** elements. As mentioned above, the design and structure of **SCE** is based on the design and structure of **BPM+** specifications like **CMMN**. However, there are some differences and additions to **SCE** when compared to the **CMMN**. If there is not an exact match between an element in **CMMN** and a corresponding element in **SCE**, then a mapping will be defined.

Table 32: Mapping to/from CMMN CMMNElement

CMMN Element/Property	SCE Element/Property
CMMNElement	<i>BaseElement</i>
CMMNElement.id	<i>BaseElement.id</i>
Not used in CMMNElement. The name property is included in specific CMMN elements that may have a name.	<i>BaseElement.name</i>
Not included in CMMN.	<i>BaseElement.aliasIds</i>

Table 33: Mapping to/from CMMN Definitions

CMMN Element/Property	SCE Element/Property
Definitions	<i>Model</i>
Definitions.name	See Element.name
Definitions.targetNamespace	<i>Model.targetNamespace</i>
Definitions.expressionLanguage	<i>Model.expressionLanguage</i>
Definitions.typeLanguage	<i>Model.typeLanguage</i>
Definitions.exporter	<i>Model.exporter</i>
Definitions.exporterVersion	<i>Model.exporterVersion</i>
Definitions.author	Not in SCE. This is CMMN specific metadata.
Definitions.creationDate	Not in SCE. This is CMMN specific metadata.
Not included in CMMN	<i>Package.tags</i>
Not included in CMMN	<i>Package.version</i>
Not included in CMMN	<i>Package.versionDate</i>

This page intentionally left blank.

Annex C: Mapping to DMN

The elements of **SCE** are not currently available for use by **DMN**. At some point, the **DMN** specification may be updated to enable their utilization of **SCE** elements. As mentioned above, the design and structure of **SCE** is based on the design and structure of **BPM+** specifications like **DMN**. However, there are some differences and additions to **SCE** when compared to the **DMN**. If there is not an exact match between an element in **DMN** and a corresponding element in **SCE**, then a mapping will be defined.

Table 34: Mapping to/from DMN DMNElement/NamedElement

DMN Element/Property	SCE Element/Property
DMNElement	<i>BaseElement</i>
DMNElement.id	<i>BaseElement.id</i>
DMNElement.Description	SCE Documentation.body
DMNElement.Label	SCE Category.name
Not used in DMN DMNElement. The name property is included in specific BPMN elements that may have a name.	<i>BaseElement.name</i>
Not included in DMN .	<i>BaseElement.aliasIds</i>
NamedElement (extends DMNElement)	Not in SCE . <i>BaseElement</i> would be a substitute.
NamedElement.name	<i>BaseElement.name</i>

Table 35: Mapping to/from DMN Definitions

DMN Element/Property	SCE Element/Property
Definitions	<i>Model</i>
Definitions.namespace	<i>Model.targetNamespace</i>
Definitions.expressionLanguage	<i>Model.expressionLanguage</i>
Definitions.typeLanguage	<i>Model.typeLanguage</i>
Definitions.exporter	<i>Model.exporter</i>
Definitions.exporterVersion	<i>Model.exporterVersion</i>
Not included in DMN	<i>Package.tags</i>
Not included in DMN	<i>Package.version</i>
Not included in DMN	<i>Package.versionDate</i>