



# MOF 2.0/XMI Mapping, Version 2.1.1

*OMG Available Specification  
with change bars*

---

OMG Document Number: formal/2007-12-02  
Standard document URL: <http://www.omg.org/spec/XMI/2.1/PDF>  
Associated Schema file\*: <http://www.omg.org/spec/XMI/20071001>  
<http://www.omg.org/spec/XMI/20071001.xml>

---

original file: ptc/07-10-06

Copyright © 2003, Adaptive  
Copyright © 2003, Compuware Corporation  
Copyright © 2003, DSTC  
Copyright © 2003, Hewlett-Packard  
Copyright © 2003, International Business Machines  
Copyright © 2003, IONA  
Copyright © 1997-2007, Object Management Group  
Copyright © 2003, SUN  
Copyright © 2003, Unisys

## USE OF SPECIFICATION - TERMS, CONDITIONS & NOTICES

The material in this document details an Object Management Group specification in accordance with the terms, conditions and notices set forth below. This document does not represent a commitment to implement any portion of this specification in any company's products. The information contained in this document is subject to change without notice.

## LICENSES

The companies listed above have granted to the Object Management Group, Inc. (OMG) a nonexclusive, royalty-free, paid up, worldwide license to copy and distribute this document and to modify this document and distribute copies of the modified version. Each of the copyright holders listed above has agreed that no person shall be deemed to have infringed the copyright in the included material of any such copyright holder by reason of having used the specification set forth herein or having conformed any computer software to the specification.

Subject to all of the terms and conditions below, the owners of the copyright in this specification hereby grant you a fully-paid up, non-exclusive, nontransferable, perpetual, worldwide license (without the right to sublicense), to use this specification to create and distribute software and special purpose specifications that are based upon this specification, and to use, copy, and distribute this specification as provided under the Copyright Act; provided that: (1) both the copyright notice identified above and this permission notice appear on any copies of this specification; (2) the use of the specifications is for informational purposes and will not be copied or posted on any network computer or broadcast in any media and will not be otherwise resold or transferred for commercial purposes; and (3) no modifications are made to this specification. This limited permission automatically terminates without notice if you breach any of these terms or conditions. Upon termination, you will destroy immediately any copies of the specifications in your possession or control.

## PATENTS

The attention of adopters is directed to the possibility that compliance with or adoption of OMG specifications may require use of an invention covered by patent rights. OMG shall not be responsible for identifying patents for which a license may be required by any OMG specification, or for conducting legal inquiries into the legal validity or scope of those patents that are brought to its attention. OMG specifications are prospective and advisory only. Prospective users are responsible for protecting themselves against liability for infringement of patents.

## GENERAL USE RESTRICTIONS

Any unauthorized use of this specification may violate copyright laws, trademark laws, and communications regulations and statutes. This document contains information which is protected by copyright. All Rights Reserved. No part of this work covered by copyright herein may be reproduced or used in any form or by any means--graphic, electronic, or mechanical, including photocopying, recording, taping, or information storage and retrieval systems--without permission of the copyright owner.

## DISCLAIMER OF WARRANTY

WHILE THIS PUBLICATION IS BELIEVED TO BE ACCURATE, IT IS PROVIDED "AS IS" AND MAY CONTAIN ERRORS OR MISPRINTS. THE OBJECT MANAGEMENT GROUP AND THE COMPANIES LISTED ABOVE MAKE NO WARRANTY OF ANY KIND, EXPRESS OR IMPLIED, WITH REGARD TO THIS PUBLICATION, INCLUDING BUT NOT LIMITED TO ANY WARRANTY OF TITLE OR OWNERSHIP, IMPLIED WARRANTY OF MERCHANTABILITY OR WARRANTY OF FITNESS FOR A PARTICULAR PURPOSE OR USE. IN NO EVENT SHALL THE OBJECT MANAGEMENT GROUP OR ANY OF THE COMPANIES LISTED ABOVE BE LIABLE FOR ERRORS CONTAINED HEREIN OR FOR DIRECT, INDIRECT, INCIDENTAL, SPECIAL, CONSEQUENTIAL, RELIANCE OR COVER DAMAGES, INCLUDING LOSS OF PROFITS, REVENUE, DATA OR USE, INCURRED BY ANY USER OR ANY THIRD PARTY IN CONNECTION WITH THE FURNISHING, PERFORMANCE, OR USE OF THIS MATERIAL, EVEN IF ADVISED OF THE POSSIBILITY OF SUCH DAMAGES.

The entire risk as to the quality and performance of software developed using this specification is borne by you. This disclaimer of warranty constitutes an essential part of the license granted to you to use this specification.

## RESTRICTED RIGHTS LEGEND

Use, duplication or disclosure by the U.S. Government is subject to the restrictions set forth in subparagraph (c) (1) (ii) of The Rights in Technical Data and Computer Software Clause at DFARS 252.227-7013 or in subparagraph (c)(1) and (2) of the Commercial Computer Software - Restricted Rights clauses at 48 C.F.R. 52.227-19 or as specified in 48 C.F.R. 227-7202-2 of the DoD F.A.R. Supplement and its successors, or as specified in 48 C.F.R. 12.212 of the Federal Acquisition Regulations and its successors, as applicable. The specification copyright owners are as indicated above and may be contacted through the Object Management Group, 140 Kendrick Street, Needham, MA 02494, U.S.A.

## TRADEMARKS

MDA®, Model Driven Architecture®, UML®, UML Cube logo®, OMG Logo®, CORBA® and XMI® are registered trademarks of the Object Management Group, Inc., and Object Management Group™, OMG™, Unified Modeling Language™, Model Driven Architecture Logo™, Model Driven Architecture Diagram™, CORBA logos™, XMI Logo™, CWM™, CWM Logo™, IOP™, MOF™, OMG Interface Definition Language (OMG IDL)™, and OMG Systems Modeling Language (OMG SysML)™ are trademarks of the Object Management Group. All other products or company names mentioned are used for identification purposes only, and may be trademarks of their respective owners.

## COMPLIANCE

The copyright holders listed above acknowledge that the Object Management Group (acting itself or through its designees) is and shall at all times be the sole entity that may authorize developers, suppliers and sellers of computer software to use certification marks, trademarks or other special designations to indicate compliance with these materials.

Software developed under the terms of this license may claim compliance or conformance with this specification if and only if the software compliance is of a nature fully matching the applicable compliance points as stated in the specification. Software developed only partially matching the applicable compliance points may claim only that the software was based on this specification, but may not claim compliance or conformance with this specification. In the event that testing suites are implemented or approved by Object Management Group, Inc., software developed using this specification may claim compliance or conformance with the specification only if the software satisfactorily completes the testing suites.



## **Notice regarding this Specification**

The XMI, v2.1.1 specification was produced in response to an urgent issue (#9512). The changes based on this issue are marked with change bars. This specification represents a revision to the XML Metadata Interchange (XMI), v2.1 specification (formal/05-09-01).



## **OMG's Issue Reporting Procedure**

All OMG specifications are subject to continuous review and improvement. As part of this process we encourage readers to report any ambiguities, inconsistencies, or inaccuracies they may find by completing the Issue Reporting Form listed on the main web page <http://www.omg.org>, under Documents, Report a Bug/Issue (<http://www.omg.org/technology/agreement.htm>).





# Table of Contents

Preface.....	V
1 Scope .....	1
2 Conformance .....	1
2.1 Introduction .....	1
2.2 Required Compliance .....	1
2.2.1 XMI Schema Compliance .....	1
2.2.2 XMI Document Compliance .....	1
2.2.3 Software Compliance .....	1
2.3 Optional Compliance Points .....	2
2.3.1 XMI Extension and Differences Compliance .....	2
2.3.2 Reverse Engineering Compliance .....	2
2.3.3 XML Schema Model Compliance .....	2
3 Additional Information .....	2
3.1 Technical Specification .....	2
3.2 Acknowledgements .....	2
4 XMI Document and Schema Design Principles .....	5
4.1 Purpose .....	5
4.2 Use of XML Schemas .....	5
4.2.1 XML Validation of XMI documents .....	6
4.2.2 Requirements for XMI Schemas .....	6
4.3 Basic Principles .....	6
4.3.1 Required XML Declarations .....	6
4.3.2 Model Class Representation .....	7
4.3.3 Model Extension Mechanism .....	7
4.4 XMI Schema and Document Structure.....	7
4.5 XMI Model .....	8
4.5.1 XML Schema for the XMI Model .....	8
4.5.2 XMI Model classes .....	8
4.5.3 XMI .....	10
4.5.4 Extension .....	11
4.5.5 Documentation .....	11
4.5.6 Add, Replace, and Delete .....	12
4.6 XMI Attributes .....	13
4.6.1 Element Identification Attributes .....	13
4.6.2 Linking Attributes .....	14
4.6.3 Version Attribute .....	15
4.6.4 Type Attribute .....	15
4.7 XMI Types .....	16
4.8 Model Representation .....	16
4.8.1 Namespace Qualified XML Element Names.....	16
4.8.2 Multiplicities .....	17

4.8.3 Class representation .....	17
4.8.4 Property Representation .....	18
4.8.5 Reference representation .....	19
4.8.6 Composite representation .....	19
4.8.7 Datatype representation .....	20
4.8.8 Inheritance representation .....	21
4.8.9 Derived Information .....	21
4.9 Transmitting Incomplete Metadata .....	21
4.9.1 Interchange of model fragments .....	21
4.9.2 XMI encoding .....	22
4.9.3 Example .....	22
4.10 Linking .....	22
4.10.1 Design principles.....	22
4.10.2 Linking .....	23
4.10.3 Example from UML 1.4 .....	24
4.11 Tailoring Schema Production .....	25
4.11.1 XMI Tag Values .....	26
4.11.2 Tag Value Constraints.....	27
4.11.3 Scope .....	28
4.11.4 XML element vs XML attribute .....	28
4.11.5 Summary of XMI Tag Scope and Affect .....	29
4.11.6 Effects on Document Production .....	30
4.11.7 Example: Customize the XML Schema for a GIS Model .....	32
4.12 Transmitting Metadata Differences .....	37
4.12.1 Definitions .....	37
4.12.2 Differences .....	38
4.12.3 XMI encoding .....	38
4.12.4 Example .....	38
4.13 Document Exchange with Multiple Tools .....	39
4.13.1 Definitions .....	40
4.13.2 Procedures .....	40
4.13.3 Example .....	41
4.14 General Datatype Mechanism .....	42
<b>5 XML Schema Production .....</b>	<b>43</b>
5.1 Purpose .....	43
5.1.1 Notation for EBNF .....	43
5.2 XMI Version 2 Schemas .....	43
5.2.1 EBNF .....	43
5.2.2 Fixed Schema Declarations .....	50
<b>6 XML Document Production .....</b>	<b>57</b>
6.1 Purpose .....	57
6.2 Introduction .....	57
6.3 Serialization Model .....	57
6.4 EBNF Rules Representation .....	58
6.4.1 Overall Document Structure.....	58
6.4.2 Object Structure .....	59
6.5 XMI Representation of the Core Packages .....	62
6.5.1 Abstractions Package .....	62

6.5.2 EMOF Package .....	63
6.5.3 CMOF Package .....	64
<b>7 Production of MOF from XML .....</b>	<b>67</b>
7.1 Introduction .....	67
7.2 DTD to MOF .....	67
7.3 XML to MOF .....	68
7.4 XML Schema to MOF.....	69
7.5 XML Schema Infoset Model .....	73
7.6 Introduction .....	73
7.7 XML Schema Structures .....	73
7.7.1 XSDAnnotation .....	81
7.7.2 XSDAttributeDeclaration .....	82
7.7.3 XSDAttributeGroupDefinition .....	82
7.7.4 XSDAttributeUse .....	83
7.7.5 XSDComplexTypeContent .....	83
7.7.6 XSDComplexTypeDefinition.....	83
7.7.7 XSDComponent .....	85
7.7.8 XSDFeature .....	85
7.7.9 XSDIdentityConstraintDefinition .....	86
7.7.10 XSDModelGroup .....	86
7.7.11 XSDNamedComponent.....	86
7.7.12 XSDSchema .....	87
7.7.13 XSDScope .....	89
7.7.14 XSDSimpleTypeDefinition .....	89
7.7.15 XSDTerm .....	92
7.7.16 XSDTypeDefinition .....	92
7.7.17 XSDWildcard .....	93
7.7.18 XSDXPathDefinition .....	93
7.8 XML Schema Datatypes .....	94
7.8.1 XSDBoundedFacet .....	97
7.8.2 XSDCardinalityFacet .....	97
7.8.3 XSDConstrainingFacet .....	97
7.8.4 XSDEnumerationFacet .....	97
7.8.5 XSDFixedFacet .....	97
7.8.6 XSDFundamentalFacet.....	97
7.8.7 XSDFacet .....	97
7.8.8 XSDFractionDigitsFacet.....	98
7.8.9 XSDLengthFacet .....	98
7.8.10 XSDMaxExclusiveFacet.....	98
7.8.11 XSDMaxFacet .....	98
7.8.12 XSDMaxInclusiveFacet .....	98
7.8.13 XSDMaxLengthFacet .....	98
7.8.14 XSDMinFacet .....	99
7.8.15 XSDMinExclusiveFacet .....	99
7.8.16 XSDMinInclusiveFacet .....	99
7.8.17 XSDMinLengthFacet .....	99
7.8.18 XSDNumericFacet .....	99
7.8.19 XSDOrderedFacet.....	99
7.8.20 XSDPatternFacet .....	100

7.8.21 XSDRepeatableFacet .....	100
7.8.22 XSDTotalDigitsFacet .....	100
7.8.23 XSDWhiteSpaceFacet .....	100
7.9 Example .....	100
References .....	105
Index .....	107

# 1 Scope

The MOF 2.0/XMI Mapping specification, v2.1.1 is based on an urgent issue and the following OMG documents:

- MOF 2.0/XMI Mapping specification, v2.1 (formal/05-09-01)
- XMI Production of XML, which defines XMI 2.0 (formal/03-05-02)
- Meta Object Facility (MOF) 2.0 Core specification (formal/06-01-01)

The main body of the document describes the technical specification itself.

## 2 Conformance

### 2.1 Introduction

This section describes the required and optional points of compliance with the XMI specification. “XMI Document” and “XMI Schema” are defined as documents and schemas produced by the XMI production (document and XML schema) rules defined in this specification.

### 2.2 Required Compliance

#### 2.2.1 XMI Schema Compliance

XMI Schemas must be equivalent to those generated by the XMI Schema production rules specified in this document. Equivalence means that XMI documents that are valid under the XMI Schema production rules would be valid in a conforming XMI Schema and that those XMI documents that are not valid under the XMI Schema production rules are not valid in a conforming XMI Schema.

#### 2.2.2 XMI Document Compliance

XMI Documents are required to conform to the following points:

- The XMI document must be “valid” and “well formed” as defined by the XML recommendation, whether used with or without the document’s corresponding XMI Schema(s). Although it is optional not to transmit and/or validate a document with its XMI Schema(s), the document must still conform as if the check had been made.
- The XMI document must be equivalent to those generated by the XMI Document production rules specified in this document. Equivalence for two documents requires a one to one correspondence between the elements in each document, each correspondence identical in terms of element name, element attributes (name and value), and contained elements. Elements declared within the XMI documentation and extension elements are excepted.

#### 2.2.3 Software Compliance

Software is XMI schema compliant when it produces XML schemas that are XMI schema compliant.

Software is XMI document compliant when it produces or consumes XML documents that are XMI document compliant.

## **2.3 Optional Compliance Points**

### **2.3.1 XMI Extension and Differences Compliance**

XMI Documents optionally conform to the following points:

- The guidelines for using the extension elements suggested in Section 4.5, “XMI Model,” on page 8 and Section 4.11, “Tailoring Schema Production,” on page 25. Tools should place their extended information within the designated extension areas, declare the nature of the extension using the standard XMI elements where applicable, and preserve the extensions of other tools where appropriate.
- Processing of XMI differencing elements (Section 4.11.6, “Effects on Document Production,” on page 30) is an optional compliance point.

### **2.3.2 Reverse Engineering Compliance**

- Each of the reverse engineering productions in Chapter 4 is an independent optional compliance point:
  - XML to MOF
  - DTD to MOF
  - Schema to MOF

### **2.3.3 XML Schema Model Compliance**

Use of the normative XML Schema model by instantiation, code generation, invocation, or serialization as defined by the MOF specification and this XMI specification for metamodel document and schema conformance.

## **3 Additional Information**

### **3.1 Technical Specification**

The technical specification is presented in the main body of this document. It represents a minor revision to XMI 2.0, as defined in XMI Production of XML Schema.

### **3.2 Acknowledgements**

The following companies submitted and/or supported parts of this specification:

- Adaptive
- Ceira Technologies, Inc.

- Compuware Corporation
- DSTC
- Hewlett-Packard
- International Business Machines
- IONA
- MetaMatrix
- Softeam
- Sun Microsystems
- Telelogic, AB
- Unisys
- University of Kent





## 4 XMI Document and Schema Design Principles

### 4.1 Purpose

This chapter contains a description of the XML documents produced from instances of MOF models, and XML schemas that may be used to allow some XML validation of these documents. The use of schemas in XMI is described first, followed by a brief description of some basic principles, which includes a short description of each XML attribute and XML element defined by XMI. Those descriptions are followed by more complete descriptions that provide examples illustrating the motivation for the XMI schema design in the areas of model class specification, transmitting incomplete metadata, linking, tailoring schema production, transmitting metadata differences, and exchanging documents between tools.

It is possible to define how to automatically generate a schema from the MOF model to represent any MOF-compliant model. That definition is presented in Chapter 7.

You may specify tag value pairs as part of the MOF model to tailor the schemas that are generated, but you are not required to do so. Using these tag value pairs requires some knowledge of XML schemas, but the schemas that are produced might perform more validation than the default schemas. See Chapter 5 for a complete description of how to generate XML schemas using these tag value pairs. Section 4.11, “Tailoring Schema Production,” on page 25 describes the tag values, their affect on schema production, and their impact on document serialization.

### 4.2 Use of XML Schemas

An XML schema provides a means by which an XML processor can validate the syntax and some of the semantics of an XML document. This specification provides rules by which a schema can be generated for any valid XMI-transmissible MOF-based model. However, the use of schemas is optional; an XML document need not reference a schema, even if one exists. The resulting document can be processed more quickly, at the cost of some loss of confidence in the quality of the document.

Although XML schemas are optional in general terms, it is incumbent on standards bodies that define MOF2 instances to produce corresponding XMI 2 Schemas for them.

It can be advantageous to perform XML validation on the XML document containing MOF model data. If XML validation is performed, any XML processor can perform some verification, relieving import/export programs of the burden of performing these checks. It is expected that the software program that performs verification will not be able to rely solely on XML validation for all of the verification since XML validation does not perform all of the verification that could be done.

Each XML document that contains model data conforming to this specification contains: XML elements that are required by this specification, XML elements that contain data that conform to a model, and, optionally, XML elements that contain metadata that represent extensions of the model. Models are explicitly identified in XML elements required by this specification. Some model information can also be encoded in an XML schema. Performing XML validation provides useful checking of the XML elements that contain metadata about the information transferred, the transfer information itself, and any extensions to the model.

The XML Namespace specification has been adopted by the W3C, allowing XMI to use multiple models at the same time. XML schema validation works with XML namespaces, so you can choose your own namespace prefixes in an XML document and use a schema to validate it. The namespace URIs, not the namespace prefixes, are used to identify which schemas to use to validate an XML document.

### 4.2.1 XML Validation of XMI documents

XML validation can determine whether the XML elements required by this specification are present in the XML document containing model data, whether XML attributes that are required in these XML elements have values for them, and whether some of the values are correct.

XML validation can also perform some verification that the model data conforms to a model. Although some checking can be done, it is impossible to rely solely on XML validation to verify that the information transferred satisfies all of a model's semantic constraints. Complete verification cannot be done through XML validation because it is not currently possible to specify all of the semantic constraints for a model in an XML schema, and the rules for automatic generation of a schema preclude the use of semantic constraints that could be encoded in a schema manually, but cannot be automatically encoded.

Finally, XML validation can be used to validate extensions to the model, because extensions must be represented as elements; if those elements are defined in a schema, the schema can be used to verify the elements.

### 4.2.2 Requirements for XMI Schemas

Each schema used by XMI must satisfy the following requirements:

- All XML elements and attributes defined by the XMI specification must be imported in the schema. They cannot be put directly in the schema itself, since there is only one target namespace per schema.
- Model constructs have corresponding element declarations, and may have an XML attribute declaration, as described below. In addition, some constructs also have a `complexType` declaration. The declarations may utilize groups, attribute groups, and types, as described below.
- Any XML elements that represent extensions to the model may be declared in a schema, although it is not necessary to do so.

By default, XMI schemas allow incomplete metadata to be transmitted, but you can enforce the lower bound of multiplicities if you wish. See Section 4.9, “Transmitting Incomplete Metadata,” on page 21” for further details.

## 4.3 Basic Principles

This section discusses the basic organization of an XML schema for XMI. Detailed information about each of these topics is included later in this chapter.

### 4.3.1 Required XML Declarations

This specification requires that XML element declarations, types, attributes, and attribute groups be included in schemas to enable XML validation of metadata that conforms to this specification. Some of these XML elements contain metadata about the metadata to be transferred, for example, the identity of the model associated with the metadata, the tool that generated the metadata, whether the metadata has been verified, etc.

All XML elements defined by this specification are in the namespace “`http://schema.omg.org/spec/XMI/version,`” where *version* is the version of the XMI specification being used. The XML namespace mechanism can be used to avoid name conflicts between the XMI elements and the XML elements from your MOF models.

In addition to required XML element declarations, there are some attributes that must be defined according to this specification. Every XML element that corresponds to a model class must have XML attributes that enable the XML element to act as a proxy for a local or remote XML element. These attributes are used to associate an XML element with another XML element. There are also other required attributes to let you put data in XML attributes rather than XML elements. You may customize the declarations using MOF tag values.

### 4.3.2 Model Class Representation

Every model class is represented in the schema by an XML element whose name is the class name, as well as a complexType whose name is the class name. The declaration of the type lists the properties of the class. By default, the content models of XML elements corresponding to model classes do not impose an order on the properties.

By default, XMI allows you to serialize features using either XML elements or XML attributes; however, XMI allows you to specify how to serialize them if you wish. Composite and multivalued properties are always serialized using XML elements.

### 4.3.3 Model Extension Mechanism

Every XMI schema contains a mechanism for extending a model class. Zero or more **extension** elements are included in the content model of each class. These extension elements have a content model of ANY, allowing considerable freedom in the nature of the extensions. The processContents attribute is lax, which means that processors will validate the elements in the extension if a schema is available for them, but will not report an error if there is no schema for them. In addition, the top level XMI element may contain zero or more **extension** elements, which provides for the inclusion of any new information. One use of the extension mechanism might be to associate display information for a particular tool with the model class represented by the XML element. Another use might be to transmit data that represents extensions to a model.

Tools that rely on XMI are expected to store the extension information and export it again to enable round trip engineering, even though it is unlikely they will be able to process it further. XML elements that are put in the **extension** elements may be declared in schemas, but are not required to be.

## 4.4 XMI Schema and Document Structure

Every XMI schema consists of the following declarations:

- An XML version processing instruction. Example: `<? XML version="1.0" ?>`
- An optional encoding declaration that specifies the character set, which follows the ISO-10646 (also called extended Unicode) standard. Example: `<? XML version="1.0" ENCODING="UCS-2" ?>`
- Any other valid XML processing instructions.
- A schema XML element.
- An import XML element for the XMI namespace.
- Declarations for a specific model.

Every XMI document consists of the following declarations, unless the XMI is embedded in another XML document:

- An XML version processing instruction.
- An optional encoding declaration that specifies the character set.

- Any other valid XML processing instructions.

XMI imposes no ordering requirements beyond those defined by XML. XML Namespaces may also be declared in the XMI element as described below.

The top element of the XMI information structure is either the XMI element, or an XML element corresponding to an instance of a class in the MOF model. An XML document containing only XMI information will have XMI as the root element of the document. It is possible for future XML exchange formats to be developed that extend XMI and embed XMI elements within their XML elements.

## 4.5 XMI Model

This section describes the model for XMI document structure, called the XMI model. The XMI model is an instance of MOF for describing the XMI-specific information in an XMI document, such as the version, documentation, extensions, and differences.

Using an XMI model enables XMI document metadata to be treated in the same fashion as other MOF metadata, allowing use of standard MOF APIs for access to and construction of XMI-specific information in the same manner as other MOF objects. A valid XMI document may contain XMI metadata but is not required to.

### 4.5.1 XML Schema for the XMI Model

When the XMI model is generated as an XML Schema following the XMI schema production rules, the result is a set of XML element and attribute declarations. These declarations are shown in Chapter 7 and given the XML namespace name of the form “<http://schema.omg.org/spec/XMI/version>,” where *version* is the version of the XMI specification being used. Every XMI-compliant schema must include the declarations of the following XML elements by importing the declarations in the XMI namespace “<http://schema.omg.org/spec/XMI/version>.” The version of this XMI specification is 2.1, and its XMI namespace is “<http://schema.omg.org/spec/XMI/2.1>.”

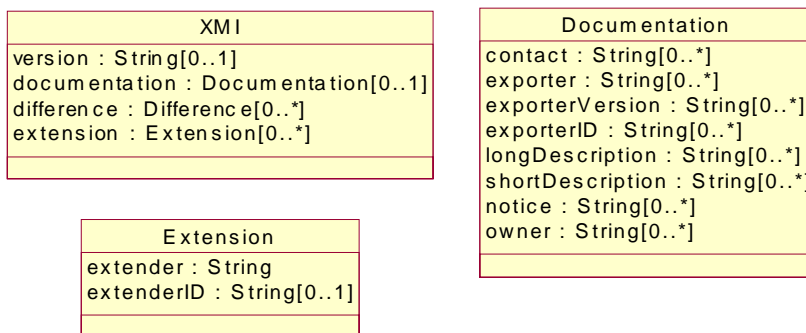
In addition, there are attribute declarations and attributeGroup declarations that must be imported. These include the id attribute, and the IdentityAttribs, LinkAttribs, and ObjectAttribs attribute groups. These constructs are not defined in the XMI model.

In the declarations that follow, the XML Schema namespace, whose URI is “<http://www.w3.org/2001/XMLSchema>,” has the namespace prefix “xsd.” The XMI namespace is the default namespace.

### 4.5.2 XMI Model classes

There are three diagrams that describe the XMI model. The details of the classes are described in the sections below. This section gives an overview of the model.

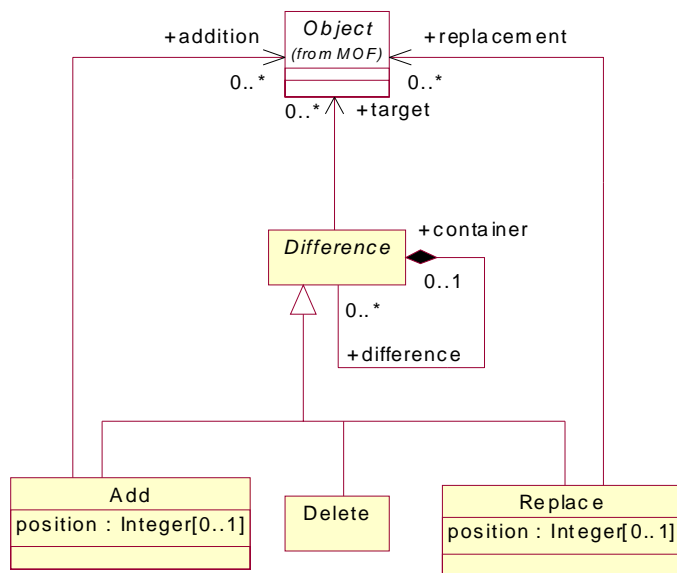
Figure 4.1 shows the XMI element, documentation, and extension elements. The XMI class is an overall default container for XMI document metadata and contents. The attributes of the XMI class are the version, documentations, differences (add, replace, delete in Figure 4.2) and extensions. The Documentation class contains many fields to describe the document for non-computational purposes. The Extension class contains the metadata for external information. The String datatype is the data type for strings in the MOF model with XML Schema data type of “<http://www.w3.org/2001/XMLSchema#string>.” The Integer datatype is the data type for integers in the MOF model with XML Schema data type of “<http://www.w3.org/2001/XMLSchema#integer>.”



**Figure 4.1 - The XMI Model for the XMI element, documentation, and extension**

The differences information (Figure 4.2) is described as additions, deletions, and replacements to target objects. The objects referenced by the differences may be in the same or different documents. The differences information consists of the Add, Delete, and Replace classes, which specify a set of differences and refer to MOF objects that are added or removed. Note that the Object class is a placeholder for specifying that a Difference has a target that can refer to any objects. The Object class is not included in the required element declarations.

The XML Schema declarations for each element of the XML model are given in the following sections. They may be generated by following the XMI production of XML Schema rules defined in Chapter 7, except for the XMI class and the XMI attributes described in Section 4.6, “XMI Attributes,” on page 13.



**Figure 4.2 - The XMI Model for differences**

### 4.5.3 XMI

The top level XML element for XMI documents containing only XMI data is the XMI element. Its declaration is:

```
<xsd:complexType name="XMI">
  <xsd:choice minOccurs="0" maxOccurs="unbounded">
    <xsd:any processContents="strict"/>
  </xsd:choice>
  <xsd:attribute ref="id"/>
  <xsd:attributeGroup ref="IdentityAttribs"/>
  <xsd:attributeGroup ref="LinkAttribs"/>
  <xsd:attribute name="type" type="xsd:QName" use="optional"
    form="qualified"/>
  <xsd:attribute name="version" type="xsd:string" use="optional"
    form="qualified"/>
</xsd:complexType>

<xsd:element name="documentation" type="Documentation"/>
<xsd:element name="difference" type="Difference"/>
<xsd:element name="extension" type="Extension"/>
<xsd:element name="XMI" type="XMI"/>
```

If the XMI **version** attribute is included, it must be set to the XMI specification version number. It indicates that the metadata conforms to that version of the XMI specification. Revised versions of this standard will have another number assigned by the OMG. The version attribute is optional, since each version of XMI has a unique namespace name of the form “<http://schema.omg.org/spec/XMI/version>.”

The XMI element need not be the root element of an XML document; you can include it inside any XML element that was not serialized according to this specification. If a document contains only XMI information, the XMI element is typically not present when there is only a single top-level object. The `xmi:version` attribute is used to denote the start of XMI information and identify the XMI version, when the XMI element itself is not present. Chapter 8 contains examples of the use of the XMI element.

The XMI class has the XMI tag `contentType` set to “any” to indicate that any XMI element may be present in the XMI stream.

The XMI version attribute has following XMI tag settings: `form` is set to “qualified,” `attribute` is set to “true,” and `enforceMinimumMultiplicity` set to “true.”

Since the XMI model is an instance of MOF, it can be serialized using the same rules as any other MOF model, with one exception. Using the default serialization rules would result in the XMI version attribute appearing twice in XMI elements: once directly from the XMI version attribute, and once through the inclusion of the `ObjectAttribs` group. Therefore, the version attribute that belongs to the `ObjectAttribs` attribute group must be excluded from the XMI type declaration. See Section 6.4.1, “Overall Document Structure,” on page 58” for details on how the XMI class is serialized.

The serialization of the XMI element is special--it is defined by the XML Document Production rules in Chapter 8.

The XMI model package has the following tag settings:

- tag `nsURI` set to “<http://schema.omg.org/spec/XMI/version>”
- tag `nsPrefix` set to “xmi”

- tag superClassFirst set to “true”
- tag useSchemaExtension set to “true”
- tag element set to “true”

#### 4.5.4 Extension

The Extension class is designed to contain extended information outside the scope of the user model. Extensions are a multivalued attribute of the XMI class and may also be embedded in specific locations in an XMI document. The Schema for extension is:

```
<xsd:complexType name="Extension">
  <xsd:choice minOccurs="0" maxOccurs="unbounded">
    <xsd:any processContents="lax"/>
  </xsd:choice>
  <xsd:attribute ref="id"/>
  <xsd:attributeGroup ref="ObjectAttribs"/>
  <xsd:attribute name="extender" type="xsd:string" use="optional"/>
  <xsd:attribute name="extenderID" type="xsd:string" use="optional"/>
</xsd:complexType>

<xsd:element name="Extension" type="Extension"/>
```

The **extender** attribute should indicate which tool made the extension. It is provided so that tools may ignore the extensions made by other tools before the content of the extensions element is processed. The **extenderID** is an optional internal ID from the extending tool. The other attributes allow individual extensions to be identified and to act as proxies for local or remote extensions.

The Extension class in the MOF model has the tag contentType set to “any” and the processContents tag set to “lax.” The extender and extenderID attributes have the tag attribute set to “true.”

#### 4.5.5 Documentation

The Documentation class contains information about the XMI document or stream being transmitted, for instance the owner of the document, a contact person for the document, long and short descriptions of the document, the exporter tool which created the document, the version of the tool, and copyright or other legal notices regarding the document. The data type of all the attributes of Documentation is string. The XML Schema generated for Documentation is:

```
<xsd:complexType name="Documentation">
  <xsd:choice minOccurs="0" maxOccurs="unbounded">
    <xsd:element name="contact" type="xsd:string"/>
    <xsd:element name="exporter" type="xsd:string"/>
    <xsd:element name="exporterVersion" type="xsd:string"/>
    <xsd:element name="longDescription" type="xsd:string"/>
    <xsd:element name="shortDescription" type="xsd:string"/>
    <xsd:element name="notice" type="xsd:string"/>
    <xsd:element name="owner" type="xsd:string"/>
    <xsd:element ref="Extension"/>
  </xsd:choice>
  <xsd:attribute ref="id"/>
  <xsd:attributeGroup ref="ObjectAttribs"/>
</xsd:complexType>
```

```

<xsd:attribute name="contact" type="xsd:string" use="optional"/>
<xsd:attribute name="exporter" type="xsd:string" use="optional"/>
<xsd:attribute name="exporterVersion" type="xsd:string" use="optional"/>
<xsd:attribute name="longDescription" type="xsd:string" use="optional"/>
<xsd:attribute name="shortDescription" type="xsd:string" use="optional"/>
<xsd:attribute name="notice" type="xsd:string" use="optional"/>
<xsd:attribute name="owner" type="xsd:string" use="optional"/>
</xsd:complexType>

<xsd:element name="Documentation" type="Documentation"/>

```

#### 4.5.6 Add, Replace, and Delete

The Add class represents an addition to a target set of objects in this document or other documents. The **position** attribute indicates where to place the addition relative to other XML elements. The default, -1, indicates to add the new elements at the end of the target element. The **addition** attribute refers to the set of objects to be added. Both of these attributes have the tag attribute set to “true.”

The Replace class represents the deletion of the target set of objects and the addition of the objects referred to in the replacement attribute. The **position** attribute indicates where to place the replacement relative to other XML elements. The default, -1, indicates to add the replacing elements at the end of the target element. The **replacement** attribute refers to the object that will replace the target element. Both of these attributes have the tag attribute set to “true.”

The Delete class represents a deletion to a target set of objects in this document or other documents.

The Difference class is the superclass for the Add, Replace, and Delete classes.

The declarations for these classes are:

```

<xsd:complexType name="Difference">
  <xsd:choice minOccurs="0" maxOccurs="unbounded">
    <xsd:element name="target">
      <xsd:complexType>
        <xsd:choice minOccurs="0" maxOccurs="unbounded">
          <xsd:any processContents="skip"/>
        </xsd:choice>
        <xsd:anyAttribute processContents="skip"/>
      </xsd:complexType>
    </xsd:element>
    <xsd:element name="difference" type="Difference"/>
    <xsd:element name="container" type="Difference"/>
    <xsd:element ref="Extension"/>
  </xsd:choice>
  <xsd:attribute ref="id"/>
  <xsd:attributeGroup ref="ObjectAttribs"/>
  <xsd:attribute name="target" type="xsd:IDREFS" use="optional"/>
  <xsd:attribute name="container" type="xsd:IDREFS" use="optional"/>
</xsd:complexType>

<xsd:element name="Difference" type="Difference"/>

```



```

<xsd:complexType name="Add">
  <xsd:complexContent>
    <xsd:extension base="Difference">
      <xsd:attribute name="position" type="xsd:string" use="optional"/>
      <xsd:attribute name="addition" type="xsd:IDREFS" use="optional"/>
    </xsd:extension>
  </xsd:complexContent>
</xsd:complexType>

<xsd:element name="Add" type="Add"/>

<xsd:complexType name="Replace">
  <xsd:complexContent>
    <xsd:extension base="Difference">
      <xsd:attribute name="position" type="xsd:string" use="optional"/>
      <xsd:attribute name="replacement" type="xsd:IDREFS" use="optional"/>
    </xsd:extension>
  </xsd:complexContent>
</xsd:complexType>

<xsd:element name="Replace" type="Replace"/>

<xsd:complexType name="Delete">
  <xsd:complexContent>
    <xsd:extension base="Difference"/>
  </xsd:complexContent>
</xsd:complexType>

<xsd:element name="Delete" type="Delete"/>

```

## 4.6 XMI Attributes

This section describes the fixed XML attributes that are used in the XMI production of XML documents and Schemas. By defining a consistent set of XML attributes, XMI provides a consistent architectural structure enabling consistent object identity and linking across all assets.

### 4.6.1 Element Identification Attributes

Three XML attributes are defined by this specification to identify XML elements so that XML elements can be associated with each other. The purpose of these attributes is to allow XML elements to reference other XML elements using XML IDREFs, XLinks, and XPointers.

Two of these attributes are declared in an attribute group called **IdentityAttribs**; the id attribute is declared globally, because you may change the name of the id attribute using the idName tag. Placing these attributes in an attribute group prevents errors in the declarations of these attributes in schemas. Its declaration is as follows:

```

<xsd:attribute name="id" type="xsd:ID" use="optional"/>

<xsd:attributeGroup name="IdentityAttribs">

```

```

<xsd:attribute name="label" type="xsd:string" use="optional"
               form="qualified"/>
<xsd:attribute name="uuid" type="xsd:string" use="optional"
               form="qualified"/>
</xsd:attributeGroup>

```

## id

XML semantics require the values of this attribute to be unique within an XML document; however, the value is not required to be globally unique. This attribute may be used as the value of the **idref** attribute defined in the next section. It may also be included as part of the value of the **href** attribute in XLinks. An example of the use of this attribute and the other attributes in this section can be found in Section 4.10.3, “Example from UML 1.4,” on page 24.

The `org.omg.xmi.idProperty` tag can be used to nominate a property of a class to be class’s id. In this case, the property is declared in the XML Schema with a type of `xsd:ID`, and no additional id attribute is serialized for objects that are instances of this class. The nominated property must be a Datatype.

## label

This attribute may be used to provide a string label identifying a particular XML element. Users may put any value in this attribute.

## uuid

The purpose of this attribute is to provide a globally unique identifier for an XML element. The values of this attribute should be globally unique strings prefixed by the type of identifier. If you have access to the UUID assigned in MOF, you may put the MOF UUID in the uuid XML attribute when encoding the MOF data in XML. For example, to include a DCE UUID as defined by The Open Group, the UUID would be preceded by “**DCE:.**” The values of this attribute may be used in the **href** attribute in simple XLinks. XMI does not specify which UUID convention is chosen.

The form of the UUID (Universally Unique Identifier) is taken from a standard defined by the Open Group (was Open Software Foundation). This standard is widely used, including by Microsoft for COM (GUIDs) and by many companies for DCE, which is based on CORBA. The method for generating these 128-bit IDs is published in the standard and the effectiveness and uniqueness of the IDs is not in practice disputed.

When a UUID is placed in an XMI file, the form is “id namespace:uuid.” The id namespace of UUIDs is typically DCE. An example is “DCE:2fac1234-31f8-11b4-a222-08002b34c003.”

The MOF `refID()` is often used as the uuid in XMI implementations.

## 4.6.2 Linking Attributes

XMI allows the use of several XML attributes to enable XML elements to refer to other XML elements using the values of the attributes defined in the previous section. The purpose of these attributes is to allow XML elements to act as simple XLinks or to hold a reference to an XML element in the same document using the XML IDREF mechanism.

The attributes described in this section are included in an attribute group called **LinkAttribs**. The attribute group declaration is:

```

<xsd:attributeGroup name="LinkAttribs">
  <xsd:attribute name="href" type="xsd:string" use="optional"/>
  <xsd:attribute name="idref" type="xsd:IDREF" use="optional"
                 form="qualified"/>
</xsd:attributeGroup>

```

`</xsd:attributeGroup>`

The link attributes act as a union of two linking mechanisms, any one of which may be used at one time. The mechanisms are the XLink **href** for advanced linking across or within a document, or the **idref** for linking within a document.

XMI offers another mechanism for linking, using the name of the property involved in the reference instead of href or idref. See Section 4.10, “Linking,” on page 22 for more information.

### Simple XLink Attributes

The href attribute declared in the above entity enables an XML element to act in a fashion compatible with the simple XLink according to the XLink and XPointer W3C recommendations. The declaration and use of href is defined in the XLink and XPointer specifications. XMI enables the use of simple XLinks. XMI does not preclude the use of extended XLinks, although it is not anticipated that many XMI tools will support them. The XLink specification defines many additional XML attributes, and it is permissible to use them in addition to the attributes defined in the LinkAttribs group.

To use simple XLinks, set **href** to the URI of the desired location. The **href** attribute can be used to reference XML elements whose **id** attributes are set to particular values. The **id** attribute value can be specified using a special URI form for XPointers defined in the XLink and XPointer recommendations.

#### idref

This attribute allows an XML element to refer to another XML element within the same document using the XML IDREF mechanism. In XMI documents, the value of this attribute should be the value of the **id** attribute of the XML element being referenced.

### 4.6.3 Version Attribute

The version attribute gives the version of the XMI specification that this object serialization conforms to.

```
<xsd:attribute name="version" type="xsd:string" fixed="2.1"/>
```

The version attribute is required only when the XMI version cannot be determined from a parent XML element:

- An XMI XML element, or
- the serialization of a parent object with a version attribute.

### 4.6.4 Type Attribute

The type attribute is used to specify the type of object being serialized, when the type is not known from the model. This can occur if the type of a reference has subclasses, for instance. The declaration of the attribute is:

```
<xsd:attribute name="type" type="xsd:QName" form="qualified"/>
```

Rather than including the IdentityAttribs, and LinkAttribs attribute groups, and the version and type attributes in the declarations for each MOF class, the XMI namespace includes the following declaration of the **ObjectAttribs** attribute group for the attribute declarations that pertain to objects:

```
<xsd:attributeGroup name="ObjectAttribs">  
  <xsd:attributeGroup ref="IdentityAttribs"/>  
  <xsd:attributeGroup ref="LinkAttribs"/>  
  <xsd:attribute name="version" type="xsd:string" use="optional"/>  
</xsd:attributeGroup>
```

```

        form="qualified"/>
    <xsd:attribute name="type" type="xsd:QName" use="optional"
        form="qualified"/>
</xsd:attributeGroup>

```

## 4.7 XMI Types

The XMI namespace contains a type called Any. It is used in the XMI schema production rules for class attributes, class references, and class compositions. The declaration of this type is part of the fixed declarations for XMI. The Any type allows any content and any attributes to appear in elements of that type, skipping XML validation for the element's content and attributes. The declaration of the type is as follows:

```

<xsd:complexType name="Any">
    <xsd:choice minOccurs="0" maxOccurs="unbounded">
        <xsd:any processContents="skip"/>
    </xsd:choice>
    <xsd:anyAttribute processContents="skip"/>
</xsd:complexType>

```

By using this type, the XMI schema production rules generate smaller schemas than if this type was declared multiple times in a schema. Also, using the Any type enables some changes to be made to the Any type declaration without affecting generated XMI schemas.

## 4.8 Model Representation

This section describes how to represent information using XMI:

- How classes, properties, composites, multiple elements, datatypes, and inheritance are represented in XMI compliant XML schemas.
- How instances of classes are represented in XMI compliant XML documents.

The production rules for these representations are given in EBNF form in the “XML Schema Production” and “XML Document Production” chapters.

### 4.8.1 Namespace Qualified XML Element Names

When the official schema for a model is produced, the schema generator must choose one or more namespace URIs that uniquely identify the XML namespaces in the model. XML processors will use those namespace URIs to identify the schemas to use for XML validation, as described in the XML schema specification.

The XML element name for each model class, package, and association in a document is its short name. The name for XML tags corresponding to model attributes and references is the short name of the attribute or reference. The name of XML attributes corresponding to model references and model attributes is the short name of the reference or attribute, since each tag in XML has its own namespace.

Each namespace is assigned a logical URI. The logical URI is placed in the namespace declaration of the XMI element in XML documents that contain instances of the model. The XML namespace specification assigns logical names to namespaces that are expected to remain fixed throughout the life of all uses of the namespace since it provides a

permanent global name for the resource. An example is “http://schema.omg.org/spec/UML/1.4.” There is no requirement or expectation by the XML Namespace specification that the logical URI be resolved or dereferenced during processing of XML documents.

The following is an example of a UML model in an XMI document using namespaces.

```
<xmi:XMI xmlns:UML="http://schema.omg.org/spec/UML/2.0"
        xmlns:xmi="http://schema.omg.org/spec/XMI/2.1">
  <UML:Class name="C1">
    <feature xmi:type="UML:Attribute" name="a1" visibility="private"/>
  </UML:Class>
</xmi:XMI>
```

The model has a single class named C1 that contains a single attribute named a1 with visibility private. The XMI element declares the version of XMI and the namespace for UML with the logical URI.

## 4.8.2 Multiplicities

In XMI 1, the multiplicities from the model were ignored, since DTDs were not able to validate multiplicities without ordering the content of XML elements. By default, XMI produces schemas that ignore multiplicities also.

You may tailor the schemas produced by XMI by specifying tag values in the model. Two of the tags, “org.omg.xmi.enforceMaximumMultiplicity” and “org.omg.xmi.enforceMinimumMultiplicity” allow you to specify that multiplicities are to be used in a schema rather than being ignored.

Model multiplicities map directly from the EMOF definition of multiplicity, which is a lower bound and an upper bound, to schema XML attributes called “minOccurs” and “maxOccurs.” The minOccurs XML attribute corresponds to MultiplicityElement’s lower property, and the maxOccurs XML attribute corresponds to its upper property. If the lower bound for a property is null, the enforceMinimumMultiplicity tag is ignored, and minimum multiplicity is not enforced in the Schema (minimum multiplicity is effectively “0”). Similarly, if the upper bound for a property is null, the enforceMaximumMultiplicity tag is ignored, and maximum multiplicity is not enforced in the Schema (the multiplicity is effectively unbounded).

## 4.8.3 Class representation

A class is represented by an XML element, with an XML element or attribute for each property. The XML element for the class includes the inherited properties.

In the examples that follow in this section, “xsd” is the namespace prefix for the XML schema namespace (“http://www.w3.org/2001/XMLSchema”) and “xmi” is the namespace prefix for the XMI namespace.

The representation of a class named “c” is shown below for the simplest case where “c” does not have any Properties:

```
<xsd:element name="c" type="c"/>

<xsd:complexType name="c">
  <xsd:choice minOccurs="0" maxOccurs="unbounded">
    <xsd:element ref="xmi:Extension"/>
  </xsd:choice>
  <xsd:attribute ref="xmi:id"/>
  <xsd:attributeGroup ref="xmi:ObjectAttribs"/>
</xsd:complexType>
```

If the class has properties, the XML elements for them are put in the all group of the content model, as explained below.

#### 4.8.4 Property Representation

The representation of properties of class “c” uses XML elements and XML attributes. If the property types are primitives or enumerations, then by default XML attributes are declared for them as well as XML elements. The reasons for this encoding choice are several, including: the values to be exchanged may be very large values and unsuitable for XML attributes, and may have poor control of whitespace processing with options that apply only to element contents. The default encoding can be changed using the XMI “attribute” and “element” tags. See Section 4.11.4, “XML element vs XML attribute,” on page 28 for information on how these tags affect encoding. See Section 4.11.1, “XMI Tag Values,” on page 26 for a complete list of XMI tags.

The declaration of a property named “a” is as follows:

```
<xsd:element name="a" type="type specification"/>
```

The XML element corresponding to the property is declared in the content of the complexType corresponding to the class that owns the attribute. The type specification is either an XML schema data type, an enumeration data type, or a class from the model.

For properties whose types are primitive types (for example, string) and whose upper bound multiplicity is 1, an XML attribute must also be declared in the XML element corresponding to model class “c,” and the XML element must be put in the content model of the XML element for class “c.” The declaration of “c” appears as follows without multiplicity enforcement:

```
<xsd:element name="c" type="c"/>

<xsd:complexType name="c">
  <xsd:choice minOccurs="0" maxOccurs="unbounded">
    <xsd:element name="a" type="xsd:string" nillable="true"/>
    <xsd:element ref="xmi:Extension"/>
  </xsd:choice>
  <xsd:attribute ref="xmi:id"/>
  <xsd:attributeGroup ref="xmi:ObjectAttribs"/>
  <xsd:attribute name="a" type="xsd:string" use="optional"/>
</xsd:complexType>
</xsd:element>
```

An element is also declared to be of XML type string if the class contains a Tag org.omg.xmi.schemaType with value “string.”

For multi-valued Properties, no XML attributes are declared; each value is encoded as an XML element.

When “a” is a property with enumerated values, the type used for the declaration of the XML element and XML attribute corresponding to the model attribute is as follows:

```
<xsd:simpleType base="enumName" >
  <xsd:restriction base="xsd:string">
    <xsd:enumeration value="v1"/>
    <xsd:enumeration value="v2"/>
  </xsd:restriction>
</xsd:simpleType>
```

where enumName is the name of the enumeration type, and v1 and v2 are the enumeration literals.

If a property has enumerated values, an XML element and an XML attribute is put in the complexType for the class “c,” their declaration is as follows:

```
<xsd:element name="a" type="enumName"/>
<xsd:attribute name="a" type="enumName" use="optional"/>
```

If a property is a multi-valued enumeration, the declaration of the XML attribute is omitted.

For properties with default values, the default value should be the XML string representation to be placed in the schema. Default values for properties should be specified in schemas with care since XML allows the processor reading the document the option of not processing a schema as an optional optimization. When tools skip processing the schema, they do not obtain the default value of XML attributes. Instead, they would have to know the default value from understanding the model. The form for specifying defaults, where “d” is the default, is:

- For string attributes, the corresponding XML attribute declaration in the XML element corresponding to the class is:

```
<xsd:attribute name="a" type="xsd:string" default="d"/>
```

- For enumeration Properties, the corresponding XML attribute declaration in the XML element corresponding to the class is:

```
<xsd:attribute name="a" type="enumTypeName" default="d"/>
```

- For a property that doesn’t have a default in the model, the Tag “org.omg.xmi.defaultValue” attached to the property will cause that default value to appear in the schema.

**Note:** When reading documents with XML elements specifying model property values, be sure to use the value in the XML element rather than the default value from the unused XML attribute.

## 4.8.5 Reference representation

A property can reference another object. Each reference is represented in an XML element and/or an XML attribute. The XML element declaration for a property named “r” for a class “c” of type “classType” is:

```
<xsd:element name="r" type="xmi:Any"/>
```

This element is declared in the content of the complexType for the class that owns the property. This declaration enables any object to be serialized, enhancing the extensibility of models. A user can override this declaration using the useSchemaExtension tag or the contentType tag.

The attribute declaration for the property, which also is included in the complexType declaration for the class that owns the property, is as follows:

```
<xsd:attribute name="r" type="xsd:IDREFS" use="optional"/>
```

## 4.8.6 Composite representation

Each property that is a composite is represented by an XML element, but not by an XML attribute. The form of the XML element is identical to that for association roles.

## 4.8.7 Datatype representation

Like classes, datatypes are classifiers and can have instances that are represented by XML elements. Unlike classes, datatypes do not have object identity, so there are no identification attributes in their representation.

The representation of a datatype named “dt” is shown below:

```
<xsd:element name="dt" type="dt"/>

<xsd:complexType name="dt">
  <xsd:choice minOccurs="0" maxOccurs="unbounded">
    <xsd:element ref="xmi:Extension"/>
  </xsd:choice>
  <xsd:attributeGroup ref="xmi:LinkAttribs"/>
  <xsd:attribute name="version" type="xsd:string" use="optional"
    form="qualified"/>
  <xsd:attribute name="type" type="xsd:QName" use="optional"
    form="qualified"/>
</xsd:complexType>
```

In the instance document, the value of the datatype appears as character content.

In CMOF, datatypes can have properties, which in effect allows them to be structured datatypes. To preserve the ability to represent datatypes in XML as simple strings, to preserve interoperability between CMOF and EMOF XMI files, the value of a structured datatype is represented as a single string, with the values of the properties of the datatypes separated by a comma or other user-defined separator (defined using the XMI valueSeparator tag).

As an example, here is a datatype called Point with two properties representing the X and Y coordinates of the point:

<<datatype>> Point
x : Integer y : Integer

A property of type Point is represented in XML as a string consisting of the values of x and y:

```
<TwoPointsOnAGraph point1="0,0" point2="1,5" />
```

A structured datatype may be more than one level deep - its properties can in turn be structured datatypes. For example:

<<datatype>> Rectangle
upperLeft : Point lowerRight : Point



The structure of the Rectangle datatype is:

```
1 Rectangle
2 upperLeft
  3 x Integer
  3 y Integer
2 lowerRight
  3 x Integer
  3 y Integer
```

The value of a property of type Rectangle is represented in XML as a string consisting of the values of the properties at the lowest level in the structure. In this example, the properties are x, y, x, y, where the first x, y are the upperLeft point and the second x, y are the lowerRight point. The XML representation of a property named area of type Rectangle looks like:

```
<aRectangle area="0,5,4,0" />
```

The X and Y coordinates of upperLeft in this example are 0,5 and for lowerRight they are 4,0.

#### **4.8.8 Inheritance representation**

XML schemas have a mechanism for extending types, but it does not support extending from more than one type, and using that mechanism imposes an order on the content models of the types that are derived from other types. Since XMI attempts to minimize order dependencies, XMI by default does not use schema extension to represent inheritance. In its place, XMI specifies that inheritance will be copy-down inheritance.

Multiple inheritance is treated in such a way that the Properties that occur more than once in the inheritance hierarchy are only included once in their subclasses. For associations (AssociationEnds with references), the actual class referenced is used, and subclasses may be used on the other end of the reference.

#### **4.8.9 Derived Information**

Whether or not information is derived information is orthogonal to whether or not that information is serialized. The `serialize` tag is provided to optionally include derived data. This capability provides more control to the end users, allowing them to customize exactly which information is present in their files. In some cases, derived information may be more condensed than the information it is derived from. In these cases, serialization of only the derived information may be desirable to keep the size of the XMI file as small as possible.

### **4.9 Transmitting Incomplete Metadata**

In XMI 2, a schema generator can decide whether to support the exchange of model fragments.

#### **4.9.1 Interchange of model fragments**

In practice, most information is related. The ability to transfer a subset of known information is essential for practical information interchange. In addition, as information models are developed, they will frequently need to be interchanged before they are complete.

The following guidelines apply for interchanging incomplete models via XMI:

- Information may be missing from a model. The transmission format should not require the addition or invention of new information.

- Model fragments may be disjoint sets. Each set may be transmitted in the same XMI file or in different XMI files.
- “Incomplete” indicates a quantity of information less than or equal to “complete.” Additional information beyond that which the model prescribes may be transmitted only via the extension mechanism.
- Semantic verification is performed on the metadata that is actually present as if it was included in complete metadata.

## 4.9.2 XMI encoding

The interchange of model fragments is accomplished by lowering the lower bound of multiplicities whose lower bound is greater than 0.

## 4.9.3 Example

The following is an example of an incomplete UML 1.4 model:

```
<UML:Model name="model1" xmi:id="id1">
  <ownedElement xmi:type="UML:Class" name="class1" xmi:id="id2">
    <feature xmi:type="UML:Attribute" name="attribute1"
      type="type1"/>
  </ownedElement>
  <ownedElement xmi:type="UML:Datatype" name="Integer" xmi:id="type1"/>
</UML:Model>
```

## 4.10 Linking

The goal is to provide a mechanism for specifying references within and across documents. Although based on the XLinks standard, it is downwards compatible and does not require XLinks as a prerequisite.

### 4.10.1 Design principles

- Links are based on XLinks to navigate to the document (which may be the current document) and XPointers to navigate to the element within the document.
- Link definitions are encapsulated in the attribute group LinkAttribs defined in Section 6.5.1, “Abstractions Package,” on page 62.
- Elements act as a union, where they are either a definition or a proxy. Proxies use the LinkAttribs attribute group to define the link, and contain no nested elements.
- LinkAttribs supports external links through the XLink attributes, and internal links through the xmi:idref and xmi:id attributes.
- Links are always to elements of the same type or subclasses of that type. Restricting proxies to reference the same element type reduces complexity, enhances reliability and type safety, and promotes caching. In XMI 2, subclasses are also allowed, to permit more flexibility in combining models.
- When acting as a proxy, XML attributes may be defined, but not contents. The XML attributes act as a cache that gives an indication if the link should be followed.
- Proxies may be chained.
- When following the link from a proxy, the definition of the proxy is replaced by the referenced element.

- It is efficient practice for maximizing caching and encapsulation to use local proxies of the same element within a document to link to a single proxy that holds an external reference.
- Association role elements typically contain proxies that link to the definitions of the classes that participate in the association.

## 4.10.2 Linking

For XMI, the most common linking requirements are:

- Linking to an XML element in the same document using the element's id.
- Linking to an XML element in a different document using the element's id.
- Linking to an XML element using the element's uuid or label, in the same or a different document.

The following sections describe how XMI supports these requirements.

### 4.10.2.1 Linking within a Document

The idref attribute may be used to specify the XML ID of an XML element within the current XML document. Every construct that can be referred to has a local XML ID, a string that is locally unique within a single XML file.

### 4.10.2.2 Linking across Documents

Supporting links across documents is optional.

#### 1. Using the XMI href attribute to locate an XMI id

This is the simplest form of cross document linking. With help from the XMI idName tag, it can be backward compatible with XMI 1.2 and later.

Here, the XMI href attribute is used to locate an XML element in another XML document by its XMI id. The value of href must be a URI reference, as defined by IETF RFC 2396: Uniform Resource Identifiers. The URI reference must be of the form URI#id\_value, where URI locates the XML file containing the XML element to link to, and id\_value is the value of the XML element's XMI id attribute.

As an example:

```
<mgr xmi:id="mgr_1" href="Co.xml#emp_2"/>
```

locates XML element `<Employee xmi:id="emp_2" ... />` in file Co.xml.

#### 2. Using an XLink simple link and XPointer bare name to locate an XMI id

This is a little more complicated than using the XMI href attribute, and does not provide any more function. It does have the advantage that standard XLink and XPointer software can follow the link.

Here, an xlink:href attribute is used, where XLink is the prefix for the XLink namespace. The XLink prefix must be declared in the document that contains the Xlink:href attribute. For example:

```
<xmi:XMI version="2.1" xmlns:xlink="http://www.w3.org/1999/XLink"
  xmlns:xmi="http://schema.omg.org/spec/XMI/2.1">
```

The value of xlink:href must again be a URI reference of the form URI#id\_value. In this case, id\_value is technically an XPointer bare name, but it looks just like the id\_value for the XMI href attribute.

The XML element with the `xlink:href` must also have an `xlink:type="simple"` attribute, to identify it as a simple link.

As an example:

```
<mgr xmi:id="mgr_1" xlink:href="Co.xml#emp_2" xlink:type="simple"/>
```

locates XML element `<Employee xmi:id="emp_2" ... />` in file `Co.xml`.

### 3. Using an XLink simple link and full XPointer to locate an XMI uuid or label

An XLink simple link and a form of full XPointer can be used to locate an XML element in an XML document by its XMI uuid or label. This describes the form for uuid; the form for label is strictly analogous. Again:

- An `xlink:href` attribute is used, where XLink is the prefix for the XLink namespace. The `xlink` prefix must be declared in the document containing the `xlink:href` attribute.
- The value of `xlink:href` must be a URI reference.

However this time, the URI reference has a more complicated form:

```
URI#xpointer(//*[@xmi:uuid='value'])[1]
```

The `xpointer` expression is a series of instructions for finding the first element in the target file whose `xmi:uuid` has that value.

As an example:

```
<mgr xmi:id="mgr_1"
  xlink:href="Co.xml#xpointer(//*[@xmi:uuid='emp_2'])[1]"
  xlink:type="simple"/>
```

locates XML element `<Employee xmi:uuid="emp_2".../>` in file `Co.xml`, as long as it is the first element with that uuid in the file.

Since a URI can identify the same file that contains the href, this also supports locating XML elements by XMI uuid in the same document.

### 4. Using full XLink and XPointer to locate almost anything

XLink and XPointer provide rich and complex capabilities for locating XML elements, far beyond what XMI requires. Consequently it is not expected that XMI implementations supporting linking across documents provide this level of support. The W3C XLink and XPointer specifications define what is possible and how it works.

#### 4.10.3 Example from UML 1.4

There is an association between `ModelElements` and `Constraints` in UML. `Operations` are a subclass of `ModelElements`. This example shows an association between `Operations` and four `Constraints` with roles `constraint` and `constrainedElement`. Each of the methods of linking is shown. The `Constraints` are shown in both definition and proxy form. Note that one of the `constrainedElement` elements contains `href="#xpointer(descendent(1,Operation,xmi:label,op1))"`. This is an example of case 4. Using full XLink and XPointer to locate almost anything.

Document 1:

```
<UML:Operation xmi:id="idO1" xmi:label="op1" xmi:uuid="DCE:1234">
```

```

<constraint xmi:id="idC1" xmi:label="co1" xmi:uuid="DCE:abcd">
  <body>First Constraint definition</body>
  <constrainedElement xmi:idref="idO1"/>
</constraint>
<constraint xmi:idref="idC2" />
<constraint xmi:idref="idC3" />
<constraint href="doc2.xml#idC4" />
</UML:Operation>
<UML:Constraint xmi:id="idC2" xmi:label="co2" xmi:uuid="DCE:efgh">
  <body>Second Constraint definition</body>
  <constrainedElement xmi:idref="idO1" />
</UML:Constraint>
<UML:Constraint xmi:id="idC3" xmi:label="co3" xmi:uuid="DCE:ijkl">
  <body>Third Constraint definition</body>
  <constrainedElement
    href="#xpointer(descendent(1,Operation,xmi:label,op1))"/>
</UML:Constraint>

```

Document 2:

```

<UML:Constraint xmi:id="idC4" xmi:label="co4" xmi:uuid="DCE:mnop">
  <body>Fourth Constraint definition</body>
  <constrainedElement href="doc1.xml#idO1"/>
</UML:Constraint>

```

The first constraint is a definition. The `constrainedElement` role contains an `Operation` proxy that has a local reference to the initial `Operation` definition using `xmi:idref`. The second constraint is a proxy referencing a constraint definition using the `xmi:idref` of “idC2.” The third constraint is a proxy reference to the definition using `xmi:idref` to the constraint “idC3.” The fourth constraint is an `XPointer` reference proxy to the definition of the constraint using the `href` to the file `doc2.xml` with id “idC4.”

Following the definition of the operation and its 3 constraint proxies are the definitions of two of the constraints. The second document contains the third constraint definition.

The use and placement of references is freely determined by the document creator. It is likely that most documents will make internal and external references for a number of reasons: to minimize the amount of duplicate declarations, to compartmentalize the size of the document streams, or to refer to useful information outside the scope of transmission. For example, the `href` of an `XLink` could contain a query to a repository that will recall additional related information. Or there may be a set of XMI documents created, one file per package to be transferred, where there are relationships between the packages.

## 4.11 Tailoring Schema Production

This section describes how to tailor schema production by specifying particular MOF tags to augment a MOF model. It also explains the impact the tailored schemas have on document production.

Note that the MOF definition of the association between `ModelElement` and `Tag` is not a composition and does not have a reference as part of `ModelElement`. This allows `Tags` to be contained in separate `Packages` and ‘remotely’ reference the tagged elements. For XMI purposes this means that the following tags can be incrementally added to an existing model without needing to be embedded in it - and thus changing it. Typically, the `Tags` could be in a separate `Package` and a

'super' package could cluster this Tags package and the model package to drive the Schema generation. This conveniently allows different Tag sets to be used with the same model (there would be a separate 'super' package for each). And the 'super' package extent allows runtime model access to the Tags package for introspection of the tags that were used for the generation.

### 4.11.1 XMI Tag Values

The following table specifies the XMI tags that allow you to tailor the schemas that are produced and the documents that are produced using XML. Each of the names has a prefix of "org.omg.xmi." The prefix is not included in the names to make the table easier to read.

**Table 4.1 - XMI Tag Values Summary**

Tag Name	Value Type	Default value	Description
<b>Naming tags</b>			
xmiName	string	nil	Provides an alternate name from the MOF name for writing to XMI. Useful in cases where the MOF name has characters that conflict with XML. This value is used rather than the MOF name.
idName	string	xmi:id	The value is the name of the id attribute.
nsURI	string	nil	The namespace URI of the MOF package.
nsPrefix	string	nil	The namespace prefix of the MOF package; this is used in schemas. (Any legal XML prefix may be used in documents.)
<b>XML Syntax tags</b>			
serialize	string	non-derived	If non-derived, then the MOF construct is serialized unless it is derived. 'true' forces the construct to be serialized regardless of whether it is derived; and 'false' suppresses it regardless.
attribute	boolean	false	If true, serializes the MOF construct as an XML attribute.
element	boolean	false	If true, serializes the MOF construct as an XML element.
remoteOnly	boolean	false	If set on one end of a bidirectional relationship, only serializes that end if it is remote.
href	boolean	false	If true, use the href attribute rather than the idref attribute for links within a document
idProperty	boolean	false	If true, use this property as the id for the object instead of the default XMI id.
valueSeparator	string	","	The value of a structured datatype (i.e. a datatype that has properties) is represented as the values of the properties separated (by default) by a comma. This tag allows the specification of a different separator.

**Table 4.1 - XMI Tag Values Summary**

Tag Name	Value Type	Default value	Description
<b>Ordering</b>			
superClassFirst	boolean	false	If true, serialize the super class content first.
ordered	boolean	false	If true, serialize object content in the order it is defined in a MOF model.
<b>Content</b>			
includeNils	boolean	false	If false, do not serialize nil values.
<b>XML Schema Production</b>			
enforceMaximumMultiplicity	boolean	false	If true, enforce maximum multiplicities; otherwise, they are “unbounded.”
enforceMinimumMultiplicity	boolean	false	If true, enforce minimum multiplicities; otherwise, they are “0.”
useSchemaExtensions	boolean	false	If true, use schema extensions to represent inheritance in the MOF model.
schemaType	string	nil	The name of a datatype defined in the XML Schema Datatype specification.
contentType	string	empty	Defines the schema content type. Other valid values are: complex, any, mixed, complex, and simple.
processContents	string	strict	If the contentType is any, this tag is used to specify the value of the processContents attribute of the any element. Other valid values are: lax, skip.
form	string	nil	Specifies the value of the form attribute for attributes. Other valid values are qualified and unqualified.
defaultValue	string	nil	Specifies the default value for attributes.
fixedValue	string	nil	Specifies the fixed value for attributes.

### 4.11.2 Tag Value Constraints

There are constraints on the values of the XMI tags in addition to the ones specified in the above table. Here is a list of them:

- If includeNils is true, and the value of an attribute is nil, the value must be represented by an XML element regardless of the value of the attribute tag. Note that MOF references cannot be set to nil.
- For class scope or multi-valued construct scope, if enforceMinimumMultiplicity or enforceMaximumMultiplicity is true, the ordered tag must be true as well (to validate multiplicities, schemas require element content to be serialized in a particular order). The multiplicity tags require the use of serializing in elements. For singlevalued construct scope, when enforceMinimumMultiplicity is true and lower bound of the multiplicity = 0 or 1, then there is no need to enforce the use of the ordered tag or the use of elements for document serialization.
- If the lower bound for a property is null, the enforceMinimumMultiplicity tag is ignored, and minimum multiplicity is

not enforced in the Schema (minimum multiplicity is effectively “0”). Similarly, if the upper bound for a property is null, the `enforceMaximumMultiplicity` tag is ignored, and maximum multiplicity is not enforced in the Schema (the multiplicity is effectively unbounded).

- If `useSchemaExtensions` is true, the MOF model must not have multiple inheritance.
- If `useSchemaExtensions` is true, `superClassFirst` must be true also.
- If `href` is true, `element` must be true as well for every reference that is serialized.
- The `attribute` tag may not be specified on containment references, multi-valued attributes, attributes without simple data types, or features with the following tags as true: `element`, `includeNils`, `enforceMinimumMultiplicity`, `enforceMaximumMultiplicity`, and `href`.
- If the `isProperty` tag is true, the `idName` tag is ignored. The tagged property must have type `Datatype`. Only one `isProperty` tag may be specified for a class.

### 4.11.3 Scope

With the exception of `xmiName`, `serialize`, and `remoteOnly`, all of these tags apply to all constructs within the scope of the construct they are assigned to. If they are specified for a MOF package, they apply to constructs within the scope of the MOF package. If they are specified for a MOF class, they apply to the MOF class and the features of the class. For example, if you set the `element` tag to true for a MOF class, you should serialize the values of all features of the class using XML elements rather than XML attributes.

The `xmiName`, `serialize`, `contentType`, `schemaType`, and `remoteOnly` tags apply only to the constructs for which they are specified. For example, setting the `xmiName` of a MOF class to “c” means that the name “c” should be used in XMI schemas and documents for that class; it does not constrain the names of the features of the class.

### 4.11.4 XML element vs XML attribute

You may choose features (MOF attribute or reference) to appear as XML attributes, XML elements, or both, based on the model and tags in the model. The following is a list of the conditions for mapping a feature to an XML construct.

#### XML attribute only

- The feature has an `attribute` tag set to true.

#### XML element only

- The feature is a containment, or
- has an `element` tag set to true, or
- has an `href` tag set to true, or
- is a multi-valued attribute, or
- is an attribute whose type is not a simple data type.

#### Both XML attribute and element

- The default



### 4.11.5 Summary of XMI Tag Scope and Affect

The table below contains the following information:

- Affect: the second column identifies the MOF constructs that are affected by a given XMI tag.
- Scope: columns 3 through 5 identify the scope of each tag. If the scope is Package Scope, a tag set on the package applies to all the affected constructs within the package. If the scope is class Scope, a tag set on the class applies to all affected constructs within the class. If the scope is Construct Scope, the tag affects only the specific construct it is set on.

By setting a tag on a package or class, you avoid setting the same tags repeatedly for classes in the package, and for attributes and association ends belonging to the class. For example, the element tag applies to attributes and association ends. If the element tag is set to true for a class, the class itself is not affected, but each attribute and association end belonging to the class is treated as if the element tag were set to true for all of them.

**Table 4.2 - XMI Tags, the MOF Constructs They Affect, and Their Scope**

XMI Tag	MOF Constructs Affected	Package Scope	Class Scope	Construct Scope
xmiName	Class, Property			X
serialize	Property	X	X	X
element	Property	X	X	X
attribute	Property	X	X	X
enforceMaximumMultiplicity	Property	X	X	X
enforceMinimumMultiplicity	Property	X	X	X
form	Property	X	X	X
remoteOnly	Property	X	X	X
href	Property	X	X	X
includeNils	Property	X	X	X
schemaType	Property			X
defaultValue	Property			X
fixedValue	Property			X
idProperty	Property			X
nsURI	Package	X		X
nsPrefix	Package	X		X
idName	Class	X	X	X
useSchemaExtensions	Class	X	X	X

contentType	Class	X	X	X
superClassFirst	Class	X	X	X

#### 4.11.6 Effects on Document Production

The values of the XMI tags affect how documents are serialized. In general, the more validation a schema performs, the more restrictions there are on the XMI documents that validate using the schemas. There are two reasons for this. First, schemas cannot validate multiplicities without imposing an order on element content. Second, if the schema extension mechanism is used, superclass elements must be serialized in element content before subclass elements.

Here are some examples of how the XMI tags affect document production. Assume that there is a MOF model with class “Super” and class “Sub.” Sub inherits from Super. Super has attribute a of type string, and Sub has attribute b with of type string. If the namespace URI is “URI,” and the prefix is “p,” here is the default schema produced from the MOF model:

```
<xml version="1.0" encoding="UTF-8"?>
<xsd:schema
  targetNamespace="URI"
  xmlns:xmi="http://schema.omg.org/spec/XMI/2.1"
  xmlns:xsd="http://www.w3.org/2001/XMLSchema"
  xmlns:p="URI">

  <xsd:import
    namespace="http://schema.omg.org/spec/XMI/2.1"
    schemaLocation="XMI.xsd"/>

  <xsd:complexType name="Super">
    <xsd:choice minOccurs="0" maxOccurs="unbounded">
      <xsd:element name="a" type="xsd:string"/>
      <xsd:element ref="xmi:Extension"/>
    </xsd:choice>
    <xsd:attribute ref="xmi:id"/>
    <xsd:attributeGroup ref="xmi:ObjectAttribs"/>
    <xsd:attribute name="a" type="xsd:string" use="optional"/>
  </xsd:complexType>

  <xsd:element name="Super" type="p:Super"/>

  <xsd:complexType name="Sub">
    <xsd:choice minOccurs="0" maxOccurs="unbounded">
      <xsd:element name="a" type="xsd:string"/>
      <xsd:element name="b" type="xsd:string"/>
      <xsd:element ref="xmi:Extension"/>
    </xsd:choice>
    <xsd:attribute ref="xmi:id"/>
    <xsd:attributeGroup ref="xmi:ObjectAttribs"/>
    <xsd:attribute name="a" type="xsd:string" use="optional"/>
    <xsd:attribute name="b" type="xsd:string" use="optional"/>
  </xsd:complexType>
```

```
<xsd:element name="Sub" type="p:Sub"/>
```

```
</xsd:schema>
```

Note that the content model for Sub allows attribute a or attribute b to be serialized first if they are serialized as elements. For example, if p is the namespace prefix for a namespace whose uri is “URI” in an XML document, the following instance of Sub validates against the default schema:

```
<p:Sub>  
  <b>Value1</b>  
  <a>Value2</a>  
</p:Sub>
```

The following is also legal:

```
<p:Sub>  
  <a>Value2</a>  
  <b>Value1</b>  
</p:Sub>
```

If useSchemaExtensions is true, the declaration of the Sub complexType uses the XML schema extension mechanism, as follows:

```
<xsd:complexType name="Sub">  
  <xsd:complexContent>  
    <xsd:extension base="p:Super">  
      <xsd:choice minOccurs="0" maxOccurs="unbounded">  
        <xsd:element name="b" type="xsd:string"/>  
      </xsd:choice>  
      <xsd:attribute name="b" type="xsd:string" use="optional"/>  
    </xsd:extension>  
  </xsd:complexContent>  
</xsd:complexType>
```

This declaration of the Sub type imposes an ordering on the content of Sub instances. With this declaration attribute a must be serialized before attribute b, so the first instance of Sub above does not validate with this schema, but the second does validate. Also, any xmi:extension elements must be serialized in Sub instances before elements corresponding to attribute b.

### 4.11.7 Example: Customize the XML Schema for a GIS Model

This example uses a model from GIS. It shows the flexibility that XMI tags give the modeler in tailoring an XML schema for a model.

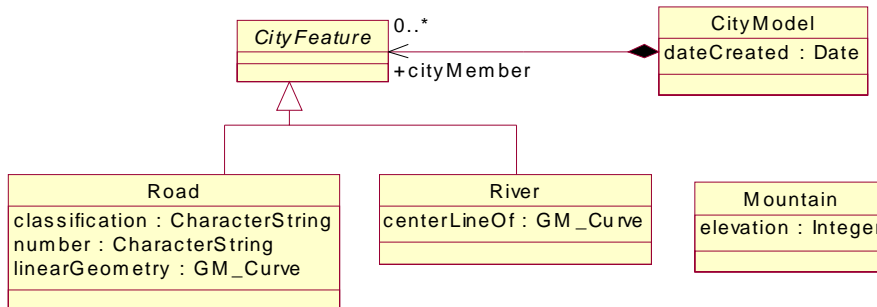


Figure 4.3 - GIS Cambridge model

The default XML schema for this model is:

```

<?xml version="1.0" encoding="UTF-8"?>
<xsd:schema xmlns:xsd="http://www.w3.org/2001/XMLSchema"
  xmlns:xmi="http://schema.omg.org/spec/XMI/2.1">
  <xsd:import namespace="http://www.omg.org/spec/XMI/2.1" schemaLocation="XMI.xsd"/>
  <xsd:annotation>
    <xsd:documentation>PACKAGE: Cambridge</xsd:documentation>
  </xsd:annotation>
  <xsd:annotation>
    <xsd:documentation>CLASS: Road</xsd:documentation>
  </xsd:annotation>
  <xsd:complexType name="Road">
    <xsd:choice minOccurs="0" maxOccurs="unbounded">
      <xsd:element name="classification" type="xsd:string" nillable="true"/>
      <xsd:element name="number" type="xsd:string" nillable="true"/>
      <xsd:element name="linearGeometry" type="xsd:string" nillable="true"/>
      <xsd:element ref="xmi:Extension"/>
    </xsd:choice>
    <xsd:attribute ref="xmi:id"/>
    <xsd:attributeGroup ref="xmi:ObjectAttribs"/>
    <xsd:attribute name="classification" type="xsd:string" use="optional"/>
    <xsd:attribute name="number" type="xsd:string" use="optional"/>
    <xsd:attribute name="linearGeometry" type="xsd:string" use="optional"/>
  </xsd:complexType>
  <xsd:element name="Road" type="Road"/>

```

```
<xsd:annotation>
  <xsd:documentation>CLASS: CityFeature</xsd:documentation>
</xsd:annotation>
```

```
<xsd:complexType name="CityFeature">
  <xsd:choice minOccurs="0" maxOccurs="unbounded">
    <xsd:element ref="xmi:Extension"/>
  </xsd:choice>
  <xsd:attribute ref="xmi:id"/>
  <xsd:attributeGroup ref="xmi:ObjectAttribs"/>
</xsd:complexType>
```

```
<xsd:element name="CityFeature" type="CityFeature"/>
```

```
<xsd:annotation>
  <xsd:documentation>CLASS: River</xsd:documentation>
</xsd:annotation>
```

```
<xsd:complexType name="River">
  <xsd:choice minOccurs="0" maxOccurs="unbounded">
    <xsd:element name="centerLineOf" type="xsd:string" nillable="true"/>
    <xsd:element ref="xmi:Extension"/>
  </xsd:choice>
  <xsd:attribute ref="xmi:id"/>
  <xsd:attributeGroup ref="xmi:ObjectAttribs"/>
  <xsd:attribute name="centerLineOf" type="xsd:string" use="optional"/>
</xsd:complexType>
```

```
<xsd:element name="River" type="River"/>
```

```
<xsd:annotation>
  <xsd:documentation>CLASS: CityModel</xsd:documentation>
</xsd:annotation>
```

```
<xsd:complexType name="CityModel">
  <xsd:choice minOccurs="0" maxOccurs="unbounded">
    <xsd:element name="dateCreated" type="xsd:string" nillable="true"/>
    <xsd:element name="cityMember" type="xmi:Any"/>
    <xsd:element ref="xmi:Extension"/>
  </xsd:choice>
  <xsd:attribute ref="xmi:id"/>
  <xsd:attributeGroup ref="xmi:ObjectAttribs"/>
  <xsd:attribute name="dateCreated" type="xsd:string" use="optional"/>
</xsd:complexType>
```

```
<xsd:element name="CityModel" type="CityModel"/>
```

```
<xsd:annotation>
  <xsd:documentation>CLASS: Mountain</xsd:documentation>
```

```

</xsd:annotation>

<xsd:complexType name="Mountain">
  <xsd:choice minOccurs="0" maxOccurs="unbounded">
    <xsd:element name="elevation" type="xsd:string" nillable="true"/>
    <xsd:element ref="xmi:Extension"/>
  </xsd:choice>
  <xsd:attribute ref="xmi:id"/>
  <xsd:attributeGroup ref="xmi:ObjectAttribs"/>
  <xsd:attribute name="elevation" type="xsd:string" use="optional"/>
</xsd:complexType>

<xsd:element name="Mountain" type="Mountain"/>

<xsd:element name="Cambridge">
  <xsd:complexType>
    <xsd:choice minOccurs="0" maxOccurs="unbounded">
      <xsd:element ref="Road"/>
      <xsd:element ref="CityFeature"/>
      <xsd:element ref="River"/>
      <xsd:element ref="CityModel"/>
      <xsd:element ref="Mountain"/>
      <xsd:element ref="xmi:Extension"/>
    </xsd:choice>
  </xsd:complexType>
</xsd:element>

</xsd:schema>

```

Some things to notice about the default schema include:

- It does not use the XML schema extension element to express inheritance. This is because XML schema does not support multiple inheritance. Instead, declarations of the superclass(es) are repeated in the subclass. For models that only use single inheritance, the ‘useSchemaExtensions’ tag signals that the xsd:extension element should be generated rather than repeating the declarations.
- XMI allows attributes with primitive values (like String) to be serialized either as XML attributes or as XML elements. This makes the default schema verbose, since it needs to take into account both possibilities. The XMI ‘element’ tag can be used to signal that attributes can be serialized only as XML elements. Similarly, the XMI ‘attribute’ tag signals the other case.
- The dateCreated attribute of the CityModel class has type string. This is because Date is not in the set of MOF primitive datatypes. This could be addressed by including datatype ‘Date’ in the model (in Rose as a class with stereotype <<primitive>> or <<alias>>) and having XMI tag ‘schemaType’ with value <http://www.w3.org/2001/XMLSchema#date>.
- xsd:choice is used to represent attributes, but does not constrain cardinality. This makes it possible to leave out an attribute or to repeat it a number of times without being caught when validating a document with the schema. You can set XMI tags “enforceMaximumMultiplicity,” “enforceMinimumMultiplicity,” and “ordered” to “true.” Also, the XMI tag “attribute” must be “false” (the default). There is a disadvantage to using these tags: in order to validate multiplicity, schemas require the XML elements be serialized in the same order as declared in the schema.

- The schema declaration for cityMember has type xmi:Any instead of type CityFeature:

```
<xsd:element name="cityMember" type="xmi:Any"/>
```

It would be useful to be able to constrain the attribute to the correct type - in this case CityFeature instead of Any. In the default case, where XMI tag useSchemaExtensions="false," using xmi:Any instead of CityFeature allows the subclasses of CityFeature (Road or River) to be serialized and validated by the schema. If we used type=CityFeature, the validator would not recognize the additional attributes in Road and River, and the document would be considered invalid. However, with XMI tag useSchemaExtensions="true," the correct type can safely be used.

By applying all the XMI tags described above, we can tailor the schema to look like:

```
<?xml version="1.0" encoding="UTF-8"?>
<xsd:schema xmlns:xsd="http://www.w3.org/2001/XMLSchema"
  xmlns:xmi="http://schema.omg.org/spec/XMI/2.1">

  <xsd:import namespace="http://www.omg.org/spec/XMI/2.1"
    schemaLocation="XMI.xsd"/>
  <xsd:annotation>
    <xsd:documentation>PACKAGE: Cambridge</xsd:documentation>
  </xsd:annotation>

  <xsd:annotation>
    <xsd:documentation>CLASS: Road</xsd:documentation>
  </xsd:annotation>

  <xsd:complexType name="Road">
    <xsd:extension base="CityFeature">
      <xsd:sequence>
        <xsd:element name="classification" type="xsd:string" nillable="true"/>
        <xsd:element name="number" type="xsd:string" nillable="true"/>
        <xsd:element name="linearGeometry" type="xsd:string" nillable="true"/>
      </xsd:sequence>
    </xsd:extension>
  </xsd:complexType>

  <xsd:element name="Road" type="Road"/>

  <xsd:annotation>
    <xsd:documentation>CLASS: CityFeature</xsd:documentation>
  </xsd:annotation>

  <xsd:complexType name="CityFeature">
    <xsd:sequence>
      <xsd:element ref="xmi:Extension" minOccurs="0"
        maxOccurs="unbounded"/>
    </xsd:sequence>
    <xsd:attribute ref="xmi:id"/>
    <xsd:attributeGroup ref="xmi:ObjectAttribs"/>
  </xsd:complexType>
```

```

<xsd:element name="CityFeature" type="CityFeature"/>

<xsd:annotation>
  <xsd:documentation>CLASS: River</xsd:documentation>
</xsd:annotation>

<xsd:complexType name="River">
  <xsd:extension base="CityFeature">
    <xsd:sequence>
      <xsd:element name="centerLineOf" type="xsd:string" nillable="true"/>
    </xsd:sequence>
  </xsd:extension>
</xsd:complexType>

<xsd:element name="River" type="River"/>

<xsd:annotation>
  <xsd:documentation>CLASS: CityModel</xsd:documentation>
</xsd:annotation>

<xsd:complexType name="CityModel">
  <xsd:sequence>
    <xsd:element name="dateCreated" type="xsd:date" nillable="true"/>
    <xsd:element name="cityMember" type="CityMember" minOccurs="0"
      maxOccurs="unbounded"/>
    <xsd:element ref="xmi:Extension" minOccurs="0"
      maxOccurs="unbounded"/>
  </xsd:sequence>
  <xsd:attribute ref="xmi:id"/>
  <xsd:attributeGroup ref="xmi:ObjectAttribs"/>
</xsd:complexType>

<xsd:element name="CityModel" type="CityModel"/>

<xsd:annotation>
  <xsd:documentation>CLASS: Mountain</xsd:documentation>
</xsd:annotation>

<xsd:complexType name="Mountain">
  <xsd:sequence>
    <xsd:element name="elevation" type="xsd:int" nillable="true"/>
    <xsd:element ref="xmi:Extension" minOccurs="0"
      maxOccurs="unbounded"/>
  </xsd:sequence>
  <xsd:attribute ref="xmi:id"/>
  <xsd:attributeGroup ref="xmi:ObjectAttribs"/>
</xsd:complexType>

```



```

<xsd:element name="Mountain" type="Mountain"/>

<xsd:element name="Cambridge">
  <xsd:complexType>
    <xsd:choice minOccurs="0" maxOccurs="unbounded">
      <xsd:element ref="Road"/>
      <xsd:element ref="CityFeature"/>
      <xsd:element ref="River"/>
      <xsd:element ref="CityModel"/>
      <xsd:element ref="Mountain"/>
      <xsd:element ref="xmi:Extension"/>
    </xsd:choice>
  </xsd:complexType>
</xsd:element>

</xsd:schema>

```

## 4.12 Transmitting Metadata Differences

The goal is to provide a mechanism for specifying the differences between documents so that an entire document does not need to be transmitted each time. This design does not specify an algorithm for computing the differences, just a form for transmitting them.

Up to now we have seen how to transmit an incomplete or full model. This way of working may not be adequate for all environments. More precisely, we could mention environments where there are many model changes that must be transmitted very quickly to other users. For these environments the full model transmission can be very resource consuming (time, network traffic, ...) making it very difficult or even not viable for finding solutions for cooperative work.

The most viable way to solve this problem is to transmit only the model changes that occur. In this way different instances of a model can be maintained and synchronized more easily and economically. Concurrent work of a group of users becomes possible with a simple mechanism to synchronize models. Transmitting less information allows synchronizing models more efficiently.

### 4.12.1 Definitions

The idea is to transmit only the changes made to the model (differences between new and old model) together with the necessary information to be able to apply the changes to the old model.

A.  $\text{New} - \text{Old} = \text{Difference}$

Model differencing is the comparison of two models and identifying the differences between them in a reversible fashion. The difference is expressed in terms of changes made to the old document to arrive at the new document.

B.  $\text{New} = \text{Old} + \text{Difference}$

Model merging is the ability to combine difference information plus a common reference model to construct the appropriate new model.

## 4.12.2 Differences

Differences **must** be applied in the order defined. A later difference may refer to information added by a previous difference by linking to its contents. Model integrity requires that all the differences transmitted are applied. The following are the types of differences recognized, the information transmitted, and the changes they represent:

- Delete (reference to deleted element): The delete operation refers to a particular element of the old model and specifies a deep removal of the referenced element and all of its contents.
- Add (reference to containing element, new element, optional position): The add operation refers to a particular element of the old model and specifies a deep addition. The element and its contents are added. The contents of the new element are added at the optional position specified, the default being as the last element of the contents. The optional position form is based on XPointer's position form. 1 means the first position, -1 means the last position, and higher numbers count across the contents in the specified direction.
- Replace (reference to replaced element, replacement element, optional position): This operation deletes the old element but not its contents. The new element and its contents are added at the position of the old element. The original contents of the old element are then added to the contents of the new element at the optional position specified, the default being at the end.

## 4.12.3 XMI encoding

The following are the elements used to encode the differences.

### delete

The delete element's link attributes contain a link to the element to be deleted.

### add

The contents of add is the element to be added. The link attributes contain a link to the element to be deleted and an optional position element. The numbering corresponds to XPointer numbering, where 1 is the first and -1 is the last element.

### replace

The contents of replace is the element to replace the old element with. The attributes contain a link to the element to be replaced and an optional position element for the replacing element's contents. The numbering corresponds to XPointer numbering, where 1 is the first and -1 is the last element.

## 4.12.4 Example

This example will delete a class and its attributes, add a second class, and rename a package. The original document:

```
<xmi:XMI xmlns:UML="http://schema.omg.org/spec/UML/1.4"
  xmlns:xmi="http://schema.omg.org/spec/XMI/2.1">
  <UML:Package xmi:id="ppp" xmi:label="p1">
    <ownedElement xmi:type="UML:Class" xmi:id="ccc" xmi:label="c1">
      <feature xmi:type="UML:Attribute" xmi:label="a1"/>
      <feature xmi:type="UML:Attribute" xmi:label="a2"/>
    </ownedElement>
  </UML:Package>
</xmi:XMI>
```

The differences document:

```
<xmi:XMI xmlns:UML="http://schema.omg.org/spec/UML/1.4"
          xmlns:xmi="http://schema.omg.org/spec/XMI/2.1">
  <difference xmi:type="xmi:Delete">
    <target href="original.xml#ccc"/>
  </difference/>
  <difference xmi:type="xmi:Add" addition="Class_1">
    <target href="original.xml#ppp"/>
  </difference>
  <UML:Class xmi:id="Class_1" xmi:label="c2"/>
  <difference xmi:type="xmi:Replace" replacement="ppp">
    <target href="original.xml#ppp"/>
  </difference>
  <UML:Package xmi:id="ppp" xmi:label="p2"/>
</xmi:XMI>
```

Here's how the 3 differences change the document as they're applied. The delete:

```
<xmi:XMI xmlns:UML="http://schema.omg.org/spec/UML/1.4"
          xmlns:xmi="http://schema.omg.org/spec/XMI/2.1">
  <UML:Package xmi:id="ppp" xmi:label="p1"/>
</xmi:XMI>
```

Next, the add:

```
<xmi:XMI xmlns:UML="http://schema.omg.org/spec/UML/1.4"
          xmlns:xmi="http://schema.omg.org/spec/XMI">
  <UML:Package xmi:id="ppp" xmi:label="p1">
    <ownedElement xmi:type="UML:Class" xmi:label="c2"/>
  </UML:Package>
</xmi:XMI>
```

Finally, the replace:

```
<xmi:XMI version="2.1" xmlns:UML="http://schema.omg.org/spec/UML/1.4"
          xmlns:xmi="http://schema.omg.org/spec/XMI/2.1">
  <UML:Package xmi:id="ppp" xmi:label="p2">
    <ownedElement xmi:type="UML:Class" xmi:label="c2"/>
  </UML:Package>
</xmi:XMI>
```

## 4.13 Document Exchange with Multiple Tools

This section contains a recommendation for an optional methodology that can be used when multiple tools interchange documents. In this methodology, the **xmi:uuid** and extensions are used together to preserve tool-specific information. In particular, tools may have particular requirements on their IDs, which makes ID interchange difficult. Extensions are used to hold tool-specific information, including tool-specific IDs.

The basic policy is that the XML ID is assigned by the tool that initially creates a construct. The **UUID** will most likely be the same as the ID the tool would choose for its own use. Any other modifiers of the document must preserve the original **UUID**, but may add their own as part of their extensions.

### 4.13.1 Definitions

General:

- MC - Model construct. An XML element that contains an `xmi.uuid` attribute.
- Extension - Extensions use the extension element. Extensions to MCs may be nested in MCs, linked to the extensions section(s) of the document, or linked outside the document. Each extension contains a tool-specific identifier in the extender attribute. Extensions are considered private to a particular tool. An MC may have zero or more extensions. Extensions may be nested.

IDs:

- **xmi:uuid** - The universally unique ID of an MC, expressed as the **xmi:uuid** attribute. Example: `<Class xmi:uuid="ABCDEFGH">`
- **extenderID** - The tool-specific ID of an MC. The **extenderID** is stored in an extension of the MC when it differs from the **xmi:uuid**.

Tool ID policies:

Every tool is either Open or Closed.

- Open tool - A tool that will accept any **xmi:uuid** as its own. Open tools do not need to add extensions to contain a tool-specific id.
- Closed tool - A tool that will not accept an **xmi:uuid** created by another tool. Closed tools store their ids in the **extenderID** attribute of an XMI.extension. The **extender** attribute of the XMI.extension is set to the name of the closed tool.

### 4.13.2 Procedures

Document Creation:

- The Creating Tool writes a new XMI document. Each MC is assigned an **xmi:uuid**. If the **xmi:uuid** differs from the **extenderID**, an **extension** for that tool is added containing the **extenderID**.

Document Import:

- The importing tool reads an existing XMI document. Extensions from other tools may be stored internally but not interpreted in the event a Modification will occur at a later time. One of the following cases occurs:
  1. If the importing tool is an Open tool, the **xmi:uuids** are accepted internally and no conversion is needed.
  2. If the importing tool is a closed tool, the tool looks for a contained extension that it recognizes (identified by extender) with an **extenderID**. If one does not exist, the importing tool creates its own internal id.

Document Modification:

- The modifying tool writes the MCs and any extensions preserved from import.
- For new MCs, the MC is assigned an **xmi:uuid**.

- Closed tools add an **extension** including their internal id in the **extenderID**.

### 4.13.3 Example

This section describes a scenario in which Tool1 creates an XMI document that is imported by Tool2, then exported to Tool1, and then a third tool imports the document. All the tools are closed tools.

1. A model is created in Tool1 with one class and written in XMI.

```
<UML:Class xmi:label="c1" xmi:uuid="abcdefgh" />
```

2. The class is imported into Tool2. Tool2 assigns extenderID “JKLMNOPQRST.” A second class is added with name “c2” and extenderID “X012345678.”

3. The model is merged back to XMI:

```
<UML:Class xmi:label="c1" xmi:uuid="abcdefgh">
  <xmi:Extension extender="Tool2" extenderID="JKLMNOPQRST" />
</UML:Class>
<UML:Class xmi:label="c2" xmi:uuid="X012345678" />
```

4. The model is imported into Tool1. Tool1 assigns extenderID “ijklmnop” to “c2” and a new class “c3” is created with extenderID “qrstuvwxyz.”

5. The model is merged back to XMI:

```
<UML:Class xmi:label="c1" xmi:uuid="abcdefgh">
  <xmi:Extension extender="Tool2" extenderID="JKLMNOPQRST" />
</UML:Class>
<UML:Class xmi:label="c2" xmi:uuid="X012345678">
  <xmi:Extension extender="Tool1" extenderID="ijklmnop" />
</UML:Class>
<UML:Class xmi:label="c3" xmi:uuid="qrstuvwxyz" />
```

6. A third closed tool, Tool3, adds its ids:

```
<UML:Class xmi:label="c1" xmi:uuid="abcdefgh">
  <xmi:Extension extender="Tool2" extenderID="JKLMNOPQRST" />
  <xmi:Extension extender="Tool3" extenderID="s1234" />
</UML:Class>
<UML:Class xmi:label="c2" xmi:uuid="X012345678">
  <xmi:Extension extender="Tool1" extenderID="ijklmnop" />
  <xmi:Extension extender="Tool3" extenderID="s5678" />
</UML:Class>
<UML:Class xmi:label="c3" xmi:uuid="qrstuvwxyz">
  <xmi:Extension extender="Tool3" extenderID="s90ab" />
</UML:Class>
```

7. An open tool imports and modifies the file. There are no changes because the **xmi:uuids** are used by the tool.

## 4.14 General Datatype Mechanism

The ability to support general data types in XMI has significant benefits. The applicability of XMI is significantly expanded since domain models are likely to have a set of domain-specific data types. This general solution allows the user to provide a domain datatype model with a defined mapping to the XML data types.

Data types are defined in the model and the XML serialization of the datatypes is described in terms of the XML schema datatypes.

MOF complex data types are treated as MOF classes with each field treated as a MOF attribute with a primitive type mapped to XML schema.

The Tag `org.omg.xmi.schemaType` indicates that this class is a datatype with XML schema mapping. The value of the tag indicates the schema type. For example, `http://www.w3.org/2001/XMLSchema#int` is the int datatype.

## 5 XML Schema Production

### 5.1 Purpose

This section describes the rules for creating a schema from a MOF-based metamodel. The conformance rules are stated in Section 2, “Conformance,” on page 1.

#### 5.1.1 Notation for EBNF

The rule sets are stated in EBNF notation. Each rule is numbered for reference. Rules are written as rule number, rule name, for example 1a. SchemaStart. Text within quotation marks are literal values, for example “<xsd:element.” Text enclosed in double slashes represents a placeholder to be filled in with the appropriate external value, for example //Name of Attribute//. Literals should be enclosed in single or double quotation marks when used as the values for XML attributes in XML documents. The suffix “\*” is used to indicate repetition of an item 0 or more times. The suffix “?” is used to indicate repetition of an item 0 or 1 times. The suffix “+” is used to indicate repetition of an item 1 or more times. The vertical bar “|” indicates a choice between two items. Parentheses “()” are used for grouping items together.

EBNF ignores white space; hence these rules do not specify white space treatment. However, since white space in XML is significant, the actual schema generation process must insert white space at the appropriate points.

### 5.2 XMI Version 2 Schemas

#### 5.2.1 EBNF

The EBNF for XMI Version 2 schemas is listed below with rule descriptions between sections.

---

```
1. Schema ::= 1a:SchemaStart
              1d:ImportsAndIncludes?
              1e:FixedDeclarations
              2:PackageSchema+
              1f:SchemaEnd

1a. SchemaStart ::= "<xsd:schema
                    xmlns:xsd='http://www.w3.org/2001/XMLSchema'
                    xmlns:xmi='http://www.omg.org/XMI' "
                    1b:NamespaceDecl*
                    1c:TargetNamespace?
                    ">"

1b. NamespaceDecl ::= "xmlns:" //Namespace name// "="
                    "" //Namespace URI// ""

1c. TargetNamespace ::= "targetNamespace='" //Namespace URI// ""

1d. ImportsAndIncludes ::= //Imports and includes//
```

---

---

```

1e. FixedDeclarations ::= "<xsd:import
                           namespace='http://www.omg.org/XMI' />"
1f. SchemaEnd         ::= "</xsd:schema>"
1g. XMIFixedAttribs   ::= ( "<xsd:attribute ref='xmi:id' "
                           "use='optional'>" |
                           "<attribute name=' " //Id attrib name// "' "
                           "type='xsd:ID' use='optional' " )
                           "<xsd:attributeGroup ref='xmi:ObjectAttribs' />"
1h. Namespace         ::= ( //Name of namespace// ":" )?

```

---

1. A schema consists of a schema XML element that contains import and include statements, fixed declarations, plus declarations for the contents of the Packages in the metamodel.
- 1a. The schema XML element consists of the schema namespace attribute, namespace attributes for the other namespaces used in the schema, if any, and an optional target namespace attribute. These rules are written as if the namespace name for the schema namespace is “xsd” and the namespace name for the XMI namespace is “xmi,” but you can substitute other names for these namespace names and still conform to this specification.
- 1b. Each namespace used in the schema must have a namespace attribute that identifies the namespace name and the namespace URI. If the namespace name is "" the attribute name should be “xmlns.” The namespace is declared by the nsPrefix and nsURI tags in the metamodel.
- 1c. If the schema has a target namespace, the targetNamespace attribute is present.
- 1d. If the schema uses declarations from other schemas, the appropriate include or import statements must be present.
- 1e. The schema declarations that are in the XMI namespace are listed in Section 5.2.2, “Fixed Schema Declarations,” on page 50.
- 1f. The end of the schema XML element.
- 1g. The fixed XMI attributes present on the major elements provide element identity and element linking. If the idName tag has a value, that value is the name of the ID attribute; otherwise, the name is “xmi:id.”
- 1h. A namespace is a namespace name followed by a “:.” If no namespace name is given, the rule is a blank.

---

```

2. PackageSchema      ::= ( 2:PackageSchema
                           | 3:ClassSchema
                           | 8:EnumSchema ) *
                           6:PackageElementDef

```

---

2. The schema contribution from a Package consists of the declarations for any contained Packages, Classes, Associations without References, enumerations, and an XML element declaration for the Package itself.



---

3. ClassSchema ::= 4:ClassTypeDef  
5:ClassElementDef

---

3. The class schema contribution consists of a type declaration based on the attributes and references of the class, and an element declaration for the Class itself.

---

4. ClassTypeDef ::= "<xsd:complexType name=' " //Name of Class//  
( "mixed='true' " )?  
" '>"  
( "<xsd:complexContent>"  
" <xsd:extension base=' " 4a:ClassTypeName " ' " )?  
( "<xsd:choice minOccurs='0'  
maxOccurs='unbounded' >" |  
" <xsd:sequence >" )?  
( 4b:ClassContents |  
" <xsd:any minOccurs='0' maxOccurs='unbounded'  
processContents=' " // ProcessContents Value //  
" ' />" )?  
( "</xsd:choice >" | "</xsd:sequence >" )?  
4g:ClassAttListItems  
( "</xsd:extension >"  
" </xsd:complexContent >" )?  
" </xsd:complexType >" )

4a. ClassTypeName ::= 1h:Namespace //Name of Class//

4b. ClassContents ::= 4d:ClassAttributes  
4e:ClassReferences  
4f:ClassCompositions  
4c:Extension

4c. Extension ::= ( "<xsd:element ref='xmi:extension' />" )\*

4d. ClassAttributes ::= ( "<xsd:element name=' " //Name of Attribute// " ' "  
( "nillable='true' " )?  
( 4m:MinOccursAttrib )?  
( 4n:MaxOccursAttrib )?  
( ("type=' " //Name of type// " ' />" ) |  
( "type='xmi:Any' />" ) ) \*

4e. ClassReferences ::= ( "<xsd:element name=' " //Name of Reference// " ' "  
( 4m:MinOccursAttrib )?  
( 4n:MaxOccursAttrib )?  
( ("type=' " 4a:ClassTypeName " ' />" ) |  
( "type='xmi:Any' />" ) ) \*

---

---

```

4f. ClassCompositions ::= ( "<xsd:element name='" //Name of Reference// "'"
                           ( 4m:MinOccursAttrib )?
                           ( 4n:MaxOccursAttrib )?
                           (("type='" 4a:ClassTypeName "'/>") |
                            ("type='xmi:Any' />")) ) *
4g. ClassAttListItems ::= 1g:XMIFixedAttribs 4h:ClassAttribAtts
4h. ClassAttribAtts   ::= ( 4i:ClassAttribRef
                           | 4j:ClassAttribData
                           | 4k:ClassAttribEnum ) *
4i. ClassAttribRef    ::= "<xsd:attribute name='" //Name of attribute// "'"
                           ("type='xsd:IDREFS' use='optional' />" |
                            "type='xsd:IDREF' use='required' />" |
                            (QName ? "type='xsd:anyURI' use='optional' />")) }
4j. ClassAttribData   ::= "<xsd:attribute name='" //Name of attribute// "'"
                           "type='xsd:string' "
                           ("use='optional' " | "use='required'")
                           ("default='" 4l:ClassAttribDflt "'")?
                           ("fixed='" 4o:ClassAttribFixed "'")?
                           ("form='" // Form value // "'")?
                           "/>"
4k. ClassAttribEnum   ::= "<xsd:attribute name='" //Name of attribute// "'"
                           "type='" 8a:EnumTypeName "' "
                           ("use='default' "
                            "value='" 4l:ClassAttribDflt "'") |
                           ("use='optional' " | "use='required'")) "/>"
4l. ClassAttribDflt   ::= //Default value//
4m. MinOccursAttrib   ::= "minOccurs='" // Minimum // "'"
4n. MaxOccursAttrib   ::= "maxOccurs='" // Maximum // "'"
4o. ClassAttribFixed  ::= //Fixed value//

```

---

4. These rules describe the declaration of a Class in the metamodel as an XML complex type with a content model and XML attributes. If either of the tags `enforceMaximumMultiplicity` or `enforceMinimumMultiplicity` is true, the contents of the class are put in a sequence; otherwise, they are put in a choice. If the `contentType` tag is complex, the class content declarations appear as defined by rule 4b; however, if the `contentType` value is empty (the default), they do not appear, and if the `contentType` value is any, the "xsd:any" element declaration appears instead of the class content. If the `contentType` value is mixed, then the mixed attribute is included. If `useSchemaExtensions` is true, the complex type for the class is derived by extension from the complex type for its superclass.
- 4a. This rule is for a reference to the type for the class, which is the name of the Class prefixed by the namespace, if present and not the default namespace.

- 4b. The complex type for the Class contains XML elements for the contained Attributes, References and Compositions of the Class, plus an extension element, regardless of whether they are marked as derived. The `serialize` tag can be used to control whether these constructs are serialized. If `useSchemaExtensions` is false or not present, inherited Attributes, References, and Compositions are included; otherwise, only local Attributes, References, and Compositions are included.
- 4c. The XML element name for each Attribute of the Class is listed as part of the content model of the Class element. This includes the Attributes defined for the Class itself as well as all of the Attributes inherited from superclasses of the Class. The type is “`xsd:string`” for simple attributes, the name of an enumeration for enumerated attributes, or the value of the `schemaType` tag, if present. For complex attributes (possible in CMOF only), when `useSchemaExtensions` is true, the name of the property type is used from rule 4, and when `useSchemaExtensions` is false, `xmi:Any` is used. If the `includeNils` tag is false, then the “`nillable`” attribute is not included in the declaration. If `enforceMinimumMultiplicity` is true, the `minOccurs` attribute is included. If `enforceMaximumMultiplicity` is true, the `maxOccurs` attribute is included.
- 4d. This rule applies to references that are not composite. The XML element name for each Reference of the Class is listed in the content model of the Class. The list includes the References defined for the Class itself, as well as all References inherited from the superclasses of the Class. The type is the class name for the Reference type if `useSchemaExtensions` is “`true`” or if the `contentType` is “`complex;`” otherwise, the type allows any object to be serialized. If `enforceMinimumMultiplicity` is true, the `minOccurs` attribute is included. If `enforceMaximumMultiplicity` is true, the `maxOccurs` attribute is included. For references (following 4.8.5), when `useSchemaExtensions` is true, the name of the property type is used from rule 4, and when `useSchemaExtensions` is false, `xmi:Any` is used.
- 4e. The XML element name for each Reference of the Class that is a composite Reference is listed in the content model of the class. The list includes the References defined for the Class itself, as well as all References inherited from the superclasses of the Class. The type is the class name for the Reference type if `useSchemaExtensions` is “`true`” or if the `contentType` is “`complex;`” otherwise, the type allows any object to be serialized. If `enforceMinimumMultiplicity` is true, the `minOccurs` attribute is included. If `enforceMaximumMultiplicity` is true, the `maxOccurs` attribute is included. For references (following 4.8.5 and/or 4.8.6), when `useSchemaExtensions` is true, the name of the property type is used from rule 4, and when `useSchemaExtensions` is false, `xmi:Any` is used.
- 4f. In addition to the standard identification and linkage attributes, the attribute list of the Class element can contain XML attributes for the Attributes and non-composite References of the Class, when the limited facilities of the XML attribute syntax allow expression of the necessary values. Inherited attributes and references are included unless the `useSchemaExtensions` tag is true, in which case only local attributes and references are included.
- 4g. References can be expressed as XML id reference XML attributes. If the multiplicity of the attribute is exactly one, and `enforceMinimumMultiplicity` is true, the type is `IDREF` and the attribute is required.
- 4h. Single-valued Attributes of a Class that have a string representation for their data are mapped to XML attributes of type “`xsd:string;`” unless the `schemaType` tag is present, in which case its value is used for the type. Multi-valued Attributes of a Class cannot be so expressed, since the XML attribute syntax does not allow repetition of values. If the multiplicity of the attribute is exactly one, and `enforceMinimumMultiplicity` is true, the attribute is required to be present.
- 4i. Single-valued Attributes that have enumerated values are mapped to XML attributes whose type is the enumerated type. If the multiplicity of the attribute is exactly one, and `enforceMinimumMultiplicity` is true, the attribute is required to be present.

- 4l. If an Attribute is expressed as an XML attribute, its default value may be expressed in the schema if there is a MOF Tag “defaultValue” attached to the Attribute. The value of this Tag must be expressible as an XML attribute string.
- 4m. The value for minimum is the minimum multiplicity.
- 4n. The value for maximum is the maximum multiplicity.
- 4o. If an Attribute is expressed as an XML attribute, its fixed value may be expressed in the schema if there is a MOF Tag “fixedValue” attached to the Attribute. The value of this Tag must be expressible as an XML attribute string.

```
5. ClassElementDef ::= "<xsd:element name=' " //Name of class// "' "
                    "type=' 4a:ClassTypeName "' />"
```

- 5. This rule declares an XML element for a class in a metamodel.

```
6. PackageElementDef ::= "<xsd:element name=' " //Name of package// "'>"
                        "<xsd:complexType>"
                        "<xsd:choice minOccurs='0' maxOccurs='unbounded'>"
                        6b: PkgContents
                        "</xsd:choice>"
                        6g: PkgAttListItems
                        "</xsd:complexType>"
                        "</xsd:element>"

6a. PkgElmtName      ::= 1h:Namespace //Name of package//
6b. PkgContents      ::= 6c: PkgAttributes
                        6d: PkgClasses
                        6e: PkgAssociations
                        6f: PkgPackages
                        4c: Extension

6c. PkgAttributes    ::= ( "<xsd:element name=' "
                            //Qualified name of Attribute// "' "
                            "type=' //Name of type// "' />")*

6d. PkgClasses       ::= ( "<xsd:element ref=' " 4a:ClassTypeName "' />")*
6e. PkgAssociations  ::= ( 7:AssociationDef )*
6f. PkgPackages      ::= ( "<xsd:element ref=' " 6a:PkgElmtName "' />")*
6g. PkgAttListItems  ::= 1g:XMIFixedAttribs 6h:PkgAttribAtts
6h. PkgAttribAtts    ::= 4h:ClassAttribAtts
```

- 6. The schema contribution from the Package consists of an XML element definition for the Package, with a content model specifying the contents of the Package.

- 6a. This rule is for the use of a package name.
- 6b. The Package contents consist of any classifier level Attributes, Associations without References, Classes, nested Packages and an extension.
- 6c. Classifier level Attributes of a Package are also known as static attributes. Such Attributes inherited from Packages from which this Package is derived are also included.
- 6d. Each Class in the Package is listed. Classes contained in Packages from which this Package is derived are also included.
- 6e. It is possible that the Package contains Associations that have no References (i.e., no Class contains a Reference which refers to an AssociationEnd owned by the Association). Every such Association contained in the Package or Package from which the Package is derived is listed as part of the Package contents in order that its information can be transmitted as part of the XML document.
- 6f. Nested Packages are listed. Nested Packages included in Packages from which this Package is derived are also included.
- 6g. The Package XML attributes are the fixed identity and linking XML attributes, as well as the XML attribute declarations corresponding to the classifier-level attributes for the classes in the package.
- 6h.

---

```

7. AssociationDef ::= "<xsd:element name=' ' 7a:AssnElmtName ' '>"
                  "<xsd:complexType>"
                  "<xsd:choice minOccurs='0' maxOccurs='unbounded'>"
                  7b:AssnContents
                  "</xsd:choice>"
                  7d:AssnAtts
                  "</xsd:complexType>"
                  "</xsd:element>"
7a. AssnElmtName ::= 1c:Namespace //Name of association//
7b. AssnContents ::= 7c:AssnEndDef
                  7c:AssnEndDef
                  4c:Extension
7c. AssnEndDef   ::= "<xsd:element"
                  "name=' ' //Name of association end// ' '>"
                  "<xsd:complexType>"
                  1g:XMIFixedAttribs
                  "</xsd:complexType>"
                  "</xsd:element>"
7d. AssnAtts     ::= 1g:XMIFixedAttribs

```

---

- 7. The declaration of an unreferenced Association consists of the names of its AssociationEnd XML elements.
- 7a. The use of the name of the XML element representing the Association.
- 7d. The fixed identity and linking XML attributes are the Association XML attributes.

---

```

8. EnumSchema ::= "<xsd:simpleType name=' " 8a:EnumType "'>"
                "<xsd:restriction base='xsd:string'>"
                8c:EnumLiterals
                "</xsd:restriction>"
                "</xsd:simpleType>"
8a. EnumTypeName ::= lh:Namespace 8b:EnumName
8b. EnumName ::= // Name of enumeration //
8c. EnumLiterals ::= ("<xsd:enumeration value=' " 8d:EnumLiteral "'/>")+
8d. EnumLiteral ::= // Name of enumeration literal //

```

---

- 8. The enumeration schema contribution consists of a simple type derived from string whose legal values are the enumeration literals.
- 8a. The name of the enumeration in XML schema references.
- 8b.
- 8c. Each enumeration literal is put in the value XML attribute of an enumeration XML element.
- 8d. The name of the enumeration literal.

## 5.2.2 Fixed Schema Declarations

There are some elements of the schema that are fixed, constituting a form of “boilerplate” necessary for every XMI 2.0 schema. These elements are described in this section. These declarations are in the namespace “http://www.omg.org/XMI.”

Only the schema content of the fixed declarations is given here. For a complete description of the semantics of these declarations, see Chapter 6.

The fixed declarations are contained in file XMI.xsd that may be imported into generated XML Schemas; or these declarations may be copied.

```

schema xmlns="http://www.w3.org/2001/XMLSchema"

<?xml version="1.0" encoding="UTF-8"?>
<xsd:schema xmlns:xsd="http://www.w3.org/2001/XMLSchema"
            xmlns="http://www.omg.org/XMI"
            targetNamespace="http://www.omg.org/XMI">

<xsd:annotation>
  <xsd:documentation>
    The following attribute and attribute group declarations are included
    in the types for MOF classes, but they are not defined in the XMI
    model.
  </xsd:documentation>
</xsd:annotation>

```

```

<xsd:attribute name="id" type="xsd:ID" use="optional"/>

<xsd:attributeGroup name="IdentityAttribs">
  <xsd:attribute name="label" type="xsd:string" use="optional"
    form="qualified"/>
  <xsd:attribute name="uuid" type="xsd:string" use="optional"
    form="qualified"/>
</xsd:attributeGroup>

<xsd:attributeGroup name="LinkAttribs">
  <xsd:attribute name="href" type="xsd:string" use="optional"/>
  <xsd:attribute name="idref" type="xsd:IDREF" use="optional"
    form="qualified"/>
</xsd:attributeGroup>

<xsd:attributeGroup name="ObjectAttribs">
  <xsd:attributeGroup ref="IdentityAttribs"/>
  <xsd:attributeGroup ref="LinkAttribs"/>
  <xsd:attribute name="version" type="xsd:string" use="optional"
    fixed="2.0" form="qualified"/>
  <xsd:attribute name="type" type="xsd:QName" use="optional"
    form="qualified"/>
</xsd:attributeGroup>

<xsd:annotation>
  <xsd:documentation>PACKAGE: XMIPackage</xsd:documentation>
</xsd:annotation>

<xsd:annotation>
  <xsd:documentation>CLASS: XMI</xsd:documentation>
</xsd:annotation>

<xsd:complexType name="XMI">
  <xsd:choice minOccurs="0" maxOccurs="unbounded">
    <xsd:any processContents="strict"/>
  </xsd:choice>
  <xsd:attribute ref="id"/>
  <xsd:attributeGroup ref="IdentityAttribs"/>
  <xsd:attributeGroup ref="LinkAttribs"/>
  <xsd:attribute name="type" type="xsd:QName" use="optional"
    form="qualified"/>
  <xsd:attribute name="version" type="xsd:string" use="required"
    fixed="2.0" form="qualified"/>
</xsd:complexType>

```

```

<xsd:element name="documentation" type="Documentation"/>
<xsd:element name="difference" type="Difference"/>
<xsd:element name="extension" type="Extension"/>
<xsd:element name="XMI" type="XMI"/>

<xsd:annotation>
  <xsd:documentation>CLASS: Documentation</xsd:documentation>
</xsd:annotation>

<xsd:complexType name="Documentation">
  <xsd:choice minOccurs="0" maxOccurs="unbounded">
    <xsd:element name="contact" type="xsd:string"/>
    <xsd:element name="exporter" type="xsd:string"/>
    <xsd:element name="exporterVersion" type="xsd:string"/>
    <xsd:element name="longDescription" type="xsd:string"/>
    <xsd:element name="shortDescription" type="xsd:string"/>
    <xsd:element name="notice" type="xsd:string"/>
    <xsd:element name="owner" type="xsd:string"/>
    <xsd:element ref="Extension"/>
  </xsd:choice>
  <xsd:attribute ref="id"/>
  <xsd:attributeGroup ref="ObjectAttribs"/>
  <xsd:attribute name="contact" type="xsd:string" use="optional"/>
  <xsd:attribute name="exporter" type="xsd:string" use="optional"/>
  <xsd:attribute name="exporterVersion" type="xsd:string"
    use="optional"/>
  <xsd:attribute name="longDescription" type="xsd:string"
    use="optional"/>
  <xsd:attribute name="shortDescription" type="xsd:string"
    use="optional"/>
  <xsd:attribute name="notice" type="xsd:string" use="optional"/>
  <xsd:attribute name="owner" type="xsd:string" use="optional"/>
</xsd:complexType>

<xsd:element name="Documentation" type="Documentation"/>

<xsd:annotation>
  <xsd:documentation>CLASS: Extension</xsd:documentation>
</xsd:annotation>

<xsd:complexType name="Extension">
  <xsd:choice minOccurs="0" maxOccurs="unbounded">
    <xsd:any processContents="lax"/>
  </xsd:choice>
</xsd:complexType>

```



```

</xsd:choice>
<xsd:attribute ref="id"/>
<xsd:attributeGroup ref="ObjectAttribs"/>
<xsd:attribute name="extender" type="xsd:string" use="optional"/>
<xsd:attribute name="extenderID" type="xsd:string" use="optional"/>
</xsd:complexType>

<xsd:element name="Extension" type="Extension"/>

<xsd:annotation>
  <xsd:documentation>CLASS: Difference</xsd:documentation>
</xsd:annotation>

<xsd:complexType name="Difference">
  <xsd:choice minOccurs="0" maxOccurs="unbounded">
    <xsd:element name="target">
      <xsd:complexType>
        <xsd:choice minOccurs="0" maxOccurs="unbounded">
          <xsd:any processContents="skip"/>
        </xsd:choice>
        <xsd:anyAttribute processContents="skip"/>
      </xsd:complexType>
    </xsd:element>
    <xsd:element name="difference" type="Difference"/>
    <xsd:element name="container" type="Difference"/>
    <xsd:element ref="Extension"/>
  </xsd:choice>
  <xsd:attribute ref="id"/>
  <xsd:attributeGroup ref="ObjectAttribs"/>
  <xsd:attribute name="target" type="xsd:IDREFS" use="optional"/>
  <xsd:attribute name="container" type="xsd:IDREFS" use="optional"/>
</xsd:complexType>

<xsd:element name="Difference" type="Difference"/>

<xsd:annotation>
  <xsd:documentation>CLASS: Add</xsd:documentation>
</xsd:annotation>

<xsd:complexType name="Add">
  <xsd:complexContent>
    <xsd:extension base="Difference">
      <xsd:attribute name="position" type="xsd:string" use="optional"/>
      <xsd:attribute name="addition" type="xsd:IDREFS" use="optional"/>
    </xsd:extension>
  </xsd:complexContent>
</xsd:complexType>

```

```

        </xsd:extension>
    </xsd:complexContent>
</xsd:complexType>

<xsd:element name="Add" type="Add"/>

<xsd:annotation>
    <xsd:documentation>CLASS: Replace</xsd:documentation>
</xsd:annotation>

<xsd:complexType name="Replace">
    <xsd:complexContent>
        <xsd:extension base="Difference">
            <xsd:attribute name="position" type="xsd:string" use="optional"/>
            <xsd:attribute name="replacement" type="xsd:IDREFS"
                use="optional"/>
        </xsd:extension>
    </xsd:complexContent>
</xsd:complexType>

<xsd:element name="Replace" type="Replace"/>

<xsd:annotation>
    <xsd:documentation>CLASS: Delete</xsd:documentation>
</xsd:annotation>

<xsd:complexType name="Delete">
    <xsd:complexContent>
        <xsd:extension base="Difference"/>
    </xsd:complexContent>
</xsd:complexType>

<xsd:element name="Delete" type="Delete"/>

<xsd:complexType name="Any">
    <xsd:choice minOccurs="0" maxOccurs="unbounded">
        <xsd:any processContents="skip"/>
    </xsd:choice>
    <xsd:anyAttribute processContents="skip"/>
</xsd:complexType>

<xsd:element name="XMIPackage">
    <xsd:complexType>
        <xsd:choice minOccurs="0" maxOccurs="unbounded">

```

```
<xsd:element ref="Difference"/>
<xsd:element ref="Add"/>
<xsd:element ref="Replace"/>
<xsd:element ref="Delete"/>
<xsd:element ref="XMI"/>
<xsd:element ref="Documentation"/>
<xsd:element ref="Extension"/>
</xsd:choice>
</xsd:complexType>
</xsd:element>

</xsd:schema>
```



## 6 XML Document Production

### 6.1 Purpose

This chapter specifies the XMI production of an XML document from a model based on the MOF 2.0 Core. The EMOF and CMOF packages of MOF 2 are shared by both UML 2 and MOF 2, so that XMI production rules support both. XMI describes an XML syntax that leverages the capability of XML schema. A set of objects are written to an XML document following the grammar defined here.

Key requirements for successful model interchange are:

- All significant aspects of the metadata are included in the XML document and can be recovered from it. No information is lost.
- The XML document is as compact as possible without loss of information.
- The XML document reflects the model being serialized in an intuitive way, in order to gain acceptance in the XML community at large.

The first requirement has been addressed by both XMI 1 and 2. The second and third requirements have been highlighted by organizations like eBXML and GIS, in which XMI 1 did not find acceptance. XMI 2 made great progress in reducing document size and improving readability. This specification maintains that progress, and streamlines the specification to make it easier to understand and implement.

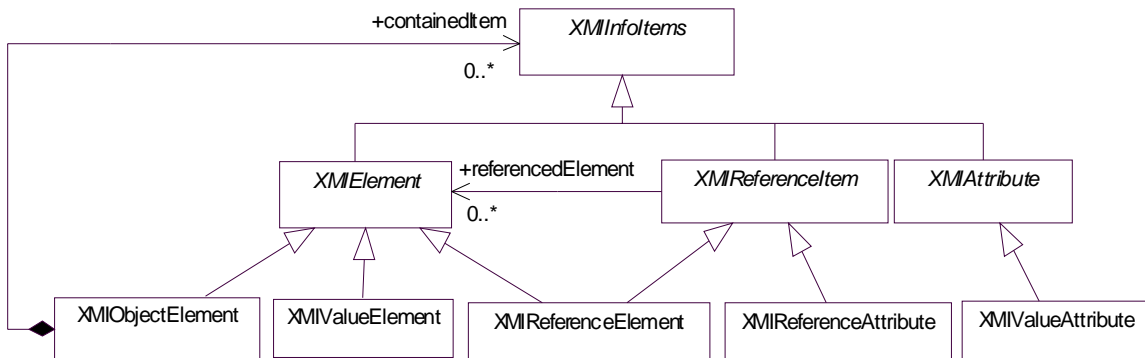
### 6.2 Introduction

XMI's XML document production process is defined as a set of production rules. When these rules are applied to a model or model fragment, the result is an XML document. The inverse of these rules can be applied to an XML document to reconstruct the model or model fragment. In both cases, the rules are implicitly applied in the context of the specific metamodel for the metadata being interchanged.

The production rules are provided as a specification of the XML document production and consumption processes. They should not be viewed as prescribing any particular algorithm for XML producer or consumer implementations.

### 6.3 Serialization Model

The number of XML serialization patterns available for use by XMI are small. These serialization patterns are shown in Figure 6.1. By limiting the XMI EBNF rules to these patterns, then mapping each modeling element to a pattern, we can reduce the size of the EBNF in the XMI spec, thus simplifying it.



**Figure 6.1- Serialization Model**

An **XMObjectElement** is an XML element that can contain other information items (XML elements and attributes). An **XMValueElement** is an XML element that can have a value, but cannot contain other XML elements or attributes. An **XMReferenceElement** is an XML element with an idref or href attribute that references another XMIElement, by id, URI, or URI and XPointer. An **XMReferenceAttribute** is an XML attribute that references an XMIElement by id. An **XMValueAttribute** is simply an XML attribute with a value.

## 6.4 EBNF Rules Representation

The XML produced by XMI is represented here in Extended Backus Naur Form (EBNF). The XML specification does not require XML processors to preserve the order of XML attributes within an XML element. Therefore, although this grammar indicates that XML attributes should be serialized in a particular order for each XML element, the XML attributes may be serialized in any order. Also, XML attributes are normalized by XML processors, so whitespace may not be preserved. You may choose to serialize parts of objects as XML elements rather than XML attributes using the `org.omg.xmi.element` tag, as explained below.

The following sections provide the production rules. The items in *italics>* are terminal values.

### 6.4.1 Overall Document Structure

---

```

1:Document ::= 1a:XMI | 2:ContentElements

1a:XMI ::= "<" 1b:XMINamespace "XMI" 1c:StartAttribs ">"
          ( 2a:XMIOBJECTELEMENT )*
          ( 5j:Extension )*
          "</" 1b:XMINamespace "XMI">"

1b:XMINamespace ::= (NsName ":" ) ?
1c:StartAttribs ::= 1d:XMIVersion 1e:Namespaces
1d:XMIVersion ::= 1b:XMINamespace "version='" XMIVersion "'"
  
```

---

---

```

1e:Namespaces      ::= 1f:XMINamespaceDecl ?
                      ( "xmlns:" 1h:NsName "=" 1i:NsURI "' " ) *
1f:XMINamespaceDecl ::= "xmlns='http://www.omg.org/XMI'" |
                      "xmlns:" NsName ="'http://www.omg.org/XMI'"
1g:Namespace      ::= ( 1h:NsName> ":" ) ?
1h:NsName          ::= Name of namespace
1i:NsURI           ::= URI of namespace

```

---

1. The content of an XMI document may be enclosed in an XMI XML element, but it does not need to be. The XML specification requires that there be one root element in an XML document for the document to be well formed.
- 1a. An XMI element has XML attributes that declare namespaces and specify the version of XMI, and the XMI element contains XML elements that make up the header, content, differences, and extensions for the XMI document.
- 1b. This rule represents the use of the XMI namespace name, XMINsName, in an XMI document. If NsName is "", this rule produces ""; otherwise, this rule produces NsName followed by ":". For example, if the XMI namespace name is "xmi," then the XML element specified in the XMI production rule has a tag name of "xmi:XMI." If the XMI namespace name is "", then the XML element specified in the XMI production rule has a tag name of "XMI."
- 1c. The start attributes include the version attribute and the declaration of namespaces used in the document.
- 1d. The version must be "2.1" for XMI documents that conform to this specification.
- 1e. The XMI namespace and the namespaces associated with a model must be declared or already be visible to the XMI element in the XML document. Since there is no requirement that the XMI XML element be the root element, these namespaces may be declared in XML elements that contain the XMI element.
- 1g. The use of a namespace name, including a ":" separator. If the namespace name is blank, the result is the empty string.
- 1h. A particular namespace name. Document producers can choose their own namespace names, as long as doing so results in legal XML documents, or they may choose to use the value of the org.omg.xmi.nsPrefix tag.
- 1i. The logical URI of the namespace. Note that namespaces are resolved to logical URIs, as opposed to physical ones, so that there is no expectation that this URI will be resolved and that there will be any information at that location. The URI is obtained from the org.omg.xmi.nsURI tag.

## 6.4.2 Object Structure

---

```

2:XMIElement      ::= 2a:XMIObjectElement | 2b:XMIValueElement
                      | 2c:XMIReferenceElement

```

---

---

```

2a:XMIObjectElement ::= ( "<" 2k:QName 2d:XMIAttributes "/>" )
                       | ( "<" 2k:QName 2d:XMIAttributes ">" (2:XMIElement)*
                           "</" 2k:QName ">" )

2b:XMIValueElement  ::= ( "<" xmiName ">" value "</" xmiName ">" )
                       | ( "<" xmiName "nil='true' />" )

2c:XMIReferenceElement ::= "<" xmiName (2g:TypeAttrib)? 2l:LinkAttribs "/>"

2d:XMIAttributes    ::= (1c:StartAttribs)?
                       (2e:IdentityAttribs)?
                       (2g:TypeAttrib)?
                       (2hFeatureAttrib)*

2e:IdentityAttribs  ::= ( 2f:IdAttribName "=" id "'")?
                       ( xmiPrefix "label='" label "' " )?
                       ( xmiPrefix "uuid='" uuid "' " )?

2f:IdAttribName     ::= xmiPrefix "id" | xmiIdAttribName

2g:TypeAttrib       ::= (1b:XMINamespace | 1g:Namespace) "type='" 2k:QName "' "

2h:FeatureAttrib    ::= X2i:MIValueAttribute | 2jXMIReferenceAttribute

2i:XMIValueAttribute ::= xmiName "=" value "' "

2j:XMIReferenceAttribute ::= xmiName "=" (refId | 2n:URIfref)+ "' "

2k:QName            ::= (prefix":")? xmiName

2l:LinkAttribs      ::= 1b:XMINamespace "idref='" refId "' " | 2m:Link

2m:Link             ::= "href='" 2n:URIfref "' "

2n:URIfref          ::= (2k:QName)? URI reference

```

---

- 2a. An object has a starting element, contents, and a closing element. If the contents are empty, you may end the starting element with `>`. You use this production rule to serialize top-level objects and to serialize objects that are the values of attributes and references.

If the object is a top-level object, the tag name is the namespace name followed by `:` and the XMI name for the object. The XMI name for the object is either the name of the object's class or the value of the `org.omg.xmi.xmiName` tag. If the object is the value of an attribute or reference, the XMI name is the name of the attribute or reference, or the value of the `org.omg.xmi.xmiName` tag. The namespace name is ignored for an object that is the value of an attribute or reference.



- 2b. Each value of a property is represented by an XML element; for multi-valued properties, there is one XML element for each value. Null values may be serialized as well, unless the value of the `org.omg.xmi.includeNils` tag is “false,” in which case you may not serialize null values.
- 2c. Use this production rule to serialize a reference to an object using an XML element. If you use identity attributes, the values of the identity attributes must match the values of the identity attributes for the object that is referenced.
- 2d. The XML attributes for an object are the optional start attributes, identity attributes, and attributes corresponding to an object’s features (its attributes and references). The start attributes must be written if the object is a top-level object and it.
- 2e. The identity attributes consist of an optional `id`, `label`, and `uuid`. If the element has a MOF `uuid`, it may be used here.
- 2f. By default, the name of the identity attribute is “`id`” in the XMI namespace. However, if an `org.omg.xmi.idName` tag has been specified, the name of the identity attribute is the value of that tag. If an `org.omg.xmi.idProperty` tag has been specified, that property will be used as the `id`, and the standard XMI `id` will not be written.
- 2g. If the class of the object cannot be determined unambiguously from the model, you must specify the class name using the “`type`” attribute. The value of this attribute is defined by the XML Schema Part 1: Structures specification to be a QName, consisting of a namespaces name for the value’s class (if there is one and it is not the default namespace for the document), a “`:`” and the name of the value’s class. The QName can be either “`xmi`” (referring to the XMI namespace) or “`xsi`” (referring to the XML Schema Instance namespace). See the schema specification for more details. You may only use the XML schema instance type attribute if `org.omg.xmi.useSchemaExtensions` is true.
- 2h. The XML attributes of the element correspond to attributes whose type is a data value or enumeration, or references whose values are objects in the document. You may not serialize an attribute or reference as both an XML element and an XML attribute in the same object. You must not serialize an attribute or reference as an XML attribute if the value of the `org.omg.xmi.element` tag is “true.” You must not serialize an attribute or reference at all if the value of the `org.omg.xmi.serialize` tag is “false;” or the value of that tag is “non-derived” and the attribute or reference has `isDerived=“true.”` You must not serialize a reference at all if the `org.omg.xmi.remoteOnly` tag is true and the reference has a value that is an object in the same XML document. You may serialize classifier-level attributes with an object.
- 2i. Use this production rule to serialize an attribute whose type is not an object and whose value can be represented by a string. Multi-valued attributes cannot be serialized as XML attributes. If the attribute’s type is one of the types defined by the XML Schema Part 2: Datatypes specification, serialize the value as specified in that specification.  
  
Also use this production rule if the attribute type is an enumeration and whose value is one of the legal enumeration literals. If the `org.omg.xmi.xmiName` is specified for the literal, the value of that tag should be used; otherwise, the name of the enumeration literal specified in the model is used.
- 2j. Use this production rule to serialize references whose values are objects that are serialized in the same document. The value of the XML attribute contains the XMI ID or URI of each referenced object, separated by a space.

- 2k. The name of an XMI element or attribute with an optional namespace prefix.
- 2l. Use the `idref` attribute to specify the id of an XML element that is referenced in the document; use the `href` attribute to specify an XML element in another document. If the `org.omg.xmi.href` tag is “true,” you must not use the `idref` attribute; use the `href` attribute for references within the document and across documents.
- 2m. An XMI link. The value of the `href` attribute is a URI reference that refers to an XML element in another document or in the same document.
- 2n. A URI Reference, optionally preceded by the type of the object being referenced. The URI reference refers to an XML element in another document or in the same document. For example, if the `href` is “file:someFile.xmi#someId,” the `href` refers to an XML element in the “someFile.xmi” document whose XMI ID is “someId.” If the URI reference is “#anotherId,” it refers to an XML element whose XMI ID is “anotherId” in the same document. XLinks are also supported in XMI. See Section 4.10.2, “Linking,” on page 23 for more information. See the W3C XLink and XPointer specification for production rules. The URI reference can be preceded by the type of the object being referenced. For example, a Property’s type is a Classifier, which is abstract. When one of the concrete subclasses of Classifier is actually instantiated, it is not clear which one it is unless the URI is dereferenced. By serializing the QName `emof:Class`, you can tell it is a Class without needing to load and process the file at the URI.

## 6.5 XMI Representation of the Core Packages

XMI production rules are defined for elements in the Abstractions, EMOF and CMOF packages in the MOF 2 Core, and for the Abstractions package in the UML Infrastructure Core. The rules for these packages are consistent and build upon each other: the rules for the EMOF package refine the Abstractions rules, and the rules for the CMOF package refine the EMOF rules. The rules are defined by mapping the model elements to the serialization model.

### 6.5.1 Abstractions Package

The rules are shown in the table below.

Instance of Model Element	XMI Representation
A Classifier	XMIObjectElement
A StructuralFeature whose value can be represented by a string.	Choice of: <ol style="list-style-type: none"> <li>1. XMIValueAttribute</li> <li>2. Nested XMIValueElement</li> </ol>
A StructuralFeature whose value cannot be represented by a string.	Choice of: <ol style="list-style-type: none"> <li>1. XMIReferenceAttribute</li> <li>2. Nested XMIReferenceElement</li> <li>3. Nested XMIObjectElement</li> </ol>

## 6.5.2 EMOF Package

The overall rules are shown in the table below.

Instance of Model Element	XMI Representation
A Package	XMIObjectElement. It may contain XMIObjectElements representing other Packages or Classes.
A Class	XMIObjectElement
A Property, type is a PrimitiveType or Enumeration	Choice of: 1. XMIValueAttribute 2. Nested XMIValueElement  The value of an Enumeration is its name.  When the value of a Property is null, it is serialized as XMIValueElement with attribute nil='true'.  When the Property is multi-valued, it is serialized as multiple nested XMIValueElements.
A Property, type is not a PrimitiveType or Enumeration, isComposite = false	Choice of: 1. XMIReferenceAttribute 2. Nested XMIReferenceElement
A Property, type is not a PrimitiveType or Enumeration, isComposite = true	Nested XMIObjectElement

The following additional rules are defined to suppress redundant information. They can be overridden using XMI tags.

- Derived information is not serialized.
- Properties whose values are the default values are not serialized.
- For Properties with isComposite=true, the opposite Property is not serialized.

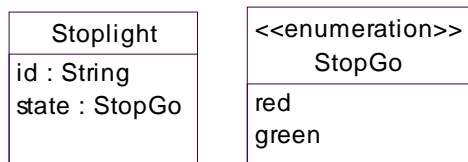
### 6.5.2.1 Examples

```
<complexco:Department xmi:id="Department_1"/>
```

Figure 6.2- Instance of a class, the namespace name is its package name.

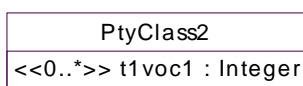
```
<Department number="13"/>
```

Figure 6.3- Instance of a class with primitive typed property.



`<Stoplight id="sl06" state="red"/>`

Figure 6.4- Instance of a class with an enumerated property.

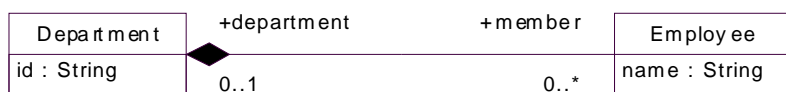


```

<PtyClass2>
  <t1voc1>1001</t1voc1>
  <t1voc1>1001</t1voc1>
</PtyClass2>

```

Figure 6.5- Multi-valued property, with each value serialized as an XML element.



```

<Department id="13">
  <member name="Glozic"/>
  <member name="Andrews"/>
</Department>

```

Figure 6.6- Composite property serialized as XML elements, the opposite property is not serialized.

### 6.5.3 CMOF Package

The overall rules are the same as for the EMOF Package, with additions shown in the table below.

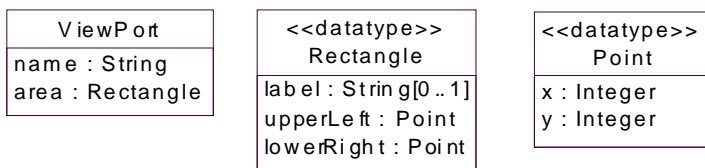
Instance of Model Element	XMI Representation
Properties of a DataType	Choice of: 1. XMIValueAttribute 2. Nested XMIValueElement  The values of the Properties are serialized as a single string separated (by default) by commas. The default separator can be overridden by the XMI valueSeparator tag.
As Association, all ends are ownedEnds	XMIObjectElement

The following additional rules are defined to suppress redundant information. They can be overridden using XMI tags:

- Additional to the first bullet in rules for the EMOF package: for some metamodels, it may be desirable to serialize particular derived Properties instead of the information they are derived from because the derived form is more compact. In this case default behavior can be overridden by setting the serialize tag to 'true' for the derived property. This means that either the base or derived form can be serialized, but for a particular serialization only one should be chosen to avoid import confusion. To allow import, derived properties should only be made serializable if they are writeable (isReadOnly=false) and it is possible to reverse-derive the base information from the derived form.
- In the case where a Property redefines another Property, only the redefining Property is serialized. (Note that when serializing an instance of a concrete supertype whose Property has been redefined, the supertype is unaware of the redefinition, and the Property as defined on the supertype is serialized.)

**Note:** No special serialization rules need to be defined for subsetted Properties. Following EMOF rule 1, when one of the subsetted or subsetting Properties is derived, it is not serialized by default. Properties that are not derived are serialized.

### 6.5.3.1 Examples



```
<ViewPort name= 'myVP' area= ",1,2,3,4" />
```

“area” is serialized as a string in which the lowest level datatype properties appear, separated by commas. In this example:

- no value was specified for label
- the value of upperLeft is “1,2”
- the value of lowerRight is “3,4”

**Figure 6.7- Datatypes with properties**



## 7 Production of MOF from XML

### 7.1 Introduction

XML is increasingly becoming an information source, supplementing existing sources such as analysis (UML), software (Java, C++), components (EJB, IDL, Corba Component Model), and databases (CWM). Although XML does not define objects, it can be used as an input source of true object definitions by supplementing the XML with additional information or conventions.

This chapter describes the following algorithms for producing object definitions in MOF from XML input sources:

- DTD to MOF production
- XML to MOF production
- XML Schema to MOF production

This section describes mappings to produce MOF declarations from XML documents, DTDs, and XML schemas. The mappings are not unique since XML-only forms of information are not rich enough to produce an unambiguous MOF representation.

These mechanisms are not necessary for reading XMI documents, since XMI is rich enough to interchange complete MOF information without loss or ambiguity.

The approach in these productions has been to provide reverse mappings for only the most common declarations used in XML. The productions are in two parts: rules and parameterized mappings. Each of the three XML information sources has its own rule to extract the corresponding class and attribute declarations they represent. The parameterized mappings are MOF rules to produce the simplest MOF classes and attributes with specific parameters that may be customized by an implementation that has additional domain knowledge beyond the production inputs.

### 7.2 DTD to MOF

When a DTD is used to create a MOF metamodel, the DTD is read declaration by declaration, and MOF definitions are added accordingly. For each type of declaration, one of the following MOF definitions is added by following the particular rule. The mapping may be customized by setting the parameters in the second table.

As an example, this DTD would by default produce these MOF declarations:

**DTD:**

```
<!ELEMENT Car (Engine, Door*)>
<!ATTLIST Car make CDATA #IMPLIED model CDATA #IMPLIED>
<!ELEMENT Engine (#PCDATA)>
<!ELEMENT Door EMPTY>
<!ATTLIST Door side CDATA #REQUIRED>
```

**MOF:**

```
Class Car {
    Attribute make : String;
    Attribute model : String;
```

```

Association engine : Engine 1..* containment one-way;
Association door : Door 1..* containment one-way;
}

Class Engine {
Attribute value : String 0..1;
}

Class Door {
Attribute side : String 0..1;
}

```

Rule	DTD Declaration	MOF Definition
1	<!ELEMENT E>	Class E with Supertype (E)
2	<!ATTLIST E A Type Occurs>	Attribute named A of Class E with type AttributeType(E, A, Type) and multiplicity AttributeMult(E, A, Occurs)
3	<!ELEMENT E (F)>	TypedElement(E, F) Attribute or Association to Class F and name RoleName(E, F)
4	<!ELEMENT E (#PCDATA)>	Attribute named TextName(E) of type AttributeType(E, TextName(E))
5	<!ELEMENT E ANY>	TypedElement(E, "ANY") Attribute or Association to Supertype("ANY") and name RoleName(E,"ANY")

Parameters	Defaults
Supertype(Element name)	Node
AttributeType (Element name, Attribute name, Type name)	String for type CDATA Lookup MOF type for IDREF
AttributeMult (Element name, Attribute name, Occurs style) TypedElement (Element name, TypedElement name)	0..1 Association: containment by value, multiplicity 0..*, one way navigable, Attribute : multiplicity 0 ..*
RoleName (Element name, TypedElement name)	LowerCase TypedElement name
TextName(Element name)	"value"

## 7.3 XML to MOF

When an XML document has no additional type information, it is possible to generalize to produce a minimal MOF representation. The mapping uses the same optional parameters as the DTD to MOF mapping.

The processing of the generalization follows these steps:

1. Parse the XML document into a DOM tree.



2. Select an existing MOF metamodel or create an empty MOF metamodel.
3. Perform a depth-first traversal of the XML document's DOM tree. At each node, apply the appropriate generalization operation from the table, based on the type of parent and child nodes encountered.

This is an example result from mapping from an XML document to MOF:

**XML:**

```
<Car make="Ford" model="Mustang">
  <Engine>240 HP</Engine>
  <Door side="left"/>
  <Door side="right"/>
</Car>
```

**MOF:**

```
Class Car {
  Attribute make : String;
  Attribute model : String;
  Association engine : Engine 1..* containment one-way;
  Association door : Door 1..* containment one-way;
}

Class Engine {
  Attribute value : String 0..1;
}

Class Door {
  Attribute side : String 0..1;
}
```

Rule	DOM Parent Node	DOM Child Node	MOF Definition
1	Element E	None	Class E with Supertype (E)
2	Element E	Attribute A	Attribute named A of Class E with type AttributeType(E, A, "CDATA") and multiplicity AttributeMult(E, A, "#IMPLIED")
4	Element E	Element F	TypedElement(E, F) Attribute or Association to Class F and name RoleName(E, F)
5	Element E	Text, ChracterData, or CDATASection	Attribute named TextName(E) of type AttributeType(E, TextName(E))

## 7.4 XML Schema to MOF

The following subset of the example of XML Schema, representing a portion of the purchase order example of the XML Schema specification, part 0, mapped to MOF using the reverse engineering table below.

The processing follows these steps:

1. The XML Schema is parsed.
2. Schema declarations corresponding to one of the three rules are processed while traversing the XML Schema depth-first.

#### XML Schema:

```

<xsd:schema xmlns:xsd="http://www.w3.org/2001/XMLSchema">

  <xsd:element name="purchaseOrder" type="PurchaseOrderType"/>

  <xsd:element name="comment" type="xsd:string"/>

  <xsd:complexType name="PurchaseOrderType">
    <xsd:sequence>
      <xsd:element name="shipTo" type="USAddress"/>
      <xsd:element name="billTo" type="USAddress"/>
      <xsd:element ref="comment" minOccurs="0"/>
    </xsd:sequence>
    <xsd:attribute name="orderDate" type="xsd:date"/>
  </xsd:complexType>

  <xsd:complexType name="USAddress">
    <xsd:sequence>
      <xsd:element name="name" type="xsd:string"/>
      <xsd:element name="street" type="xsd:string"/>
      <xsd:element name="city" type="xsd:string"/>
      <xsd:element name="state" type="xsd:string"/>
      <xsd:element name="zip" type="xsd:decimal"/>
    </xsd:sequence>
    <xsd:attribute name="country" type="xsd:NMTOKEN"
      fixed="US"/>
  </xsd:complexType>

</xsd:schema>

```

#### MOF:

```

<Class name="PurchaseOrder">
  <attribute name="shipTo" type="USAddress"/>
  <attribute name="billTo" type="USAddress"/>
  <attribute name="comment" type="mof:String" multiplicity="0..1"/>
  <attribute name="orderDate" type="mof:String"/>
</Class>
<Class name="USAddress">
  <attribute name="name" type="mof:String"/>
  <attribute name="street" type="mof:String"/>
  <attribute name="city" type="mof:String"/>
  <attribute name="state" type="mof:String"/>
  <attribute name="zip" type="mof:Integer"/>
  <attribute name="country" type="mof:String"/>
</Class>

```

Data types map to “mof:String” unless defined in the user model, except “xsd:decimal” and its restrictions map to “mof:Integer” and “xsd:boolean” maps to “mof:boolean.”

<b>Rule</b>	<b>XML Schema</b>	<b>MOF Definition</b>
1	Element(E), ComplexType(E), SimpleType(E) with base (S)	Class E with Supertype(S)
2	Sequence(L), List(L), Choice(L) containing Rule 1 (E2) and minOccurs(min), maxOccurs(max)	Attribute E2 of AttributeType (E, L, E2) with multiplicity min..max
3	Attribute(A) Type(T)	Attribute A with AttributeType(E, A, T)



## 8 XML Schema Infoset Model

### 8.1 Introduction

This chapter describes the MOF model for XML Schema using UML notation. The model is a straightforward mapping from the XML Schema specification: classes in the model have a direct correspondence to XML Schema components.

This model replaces the XSD model in the XMI 2.0 specification (<http://www.omg.org/technology/documents/formal/xmi.htm>), which was created prior to the introduction of the XML Infoset and the XML Schema abstract data model into the XML Schema specification. This model is called the XML Schema Infoset Model to distinguish it from the earlier version.

The specification of the XML Schema Infoset model assumes a strong working knowledge of XML Schema and refers throughout to the XML Schema specification for the detailed description of constructs that are defined by XML Schema.

The description of the model is divided into two sections: the first describing elements of the model that primarily represent XML Structures, and the second describing elements that primarily represent XML Schema Datatypes.

The final section of this chapter shows an example of an XML Schema represented as an instance of the XSD Infoset model.

The model diagrams are color coded for easier reading:

- Yellow - concrete classes
- Turquoise - abstract classes
- Orange - enumerations
- Gray - datatypes

### 8.2 XML Schema Structures

This section defines the model elements corresponding to XML Schema Part 1, Structures. There are eight diagrams in this section. The first set of diagrams show aspects of the XSD Infoset model that represent the XML Schema abstract data model defined in the XML Schema specification:

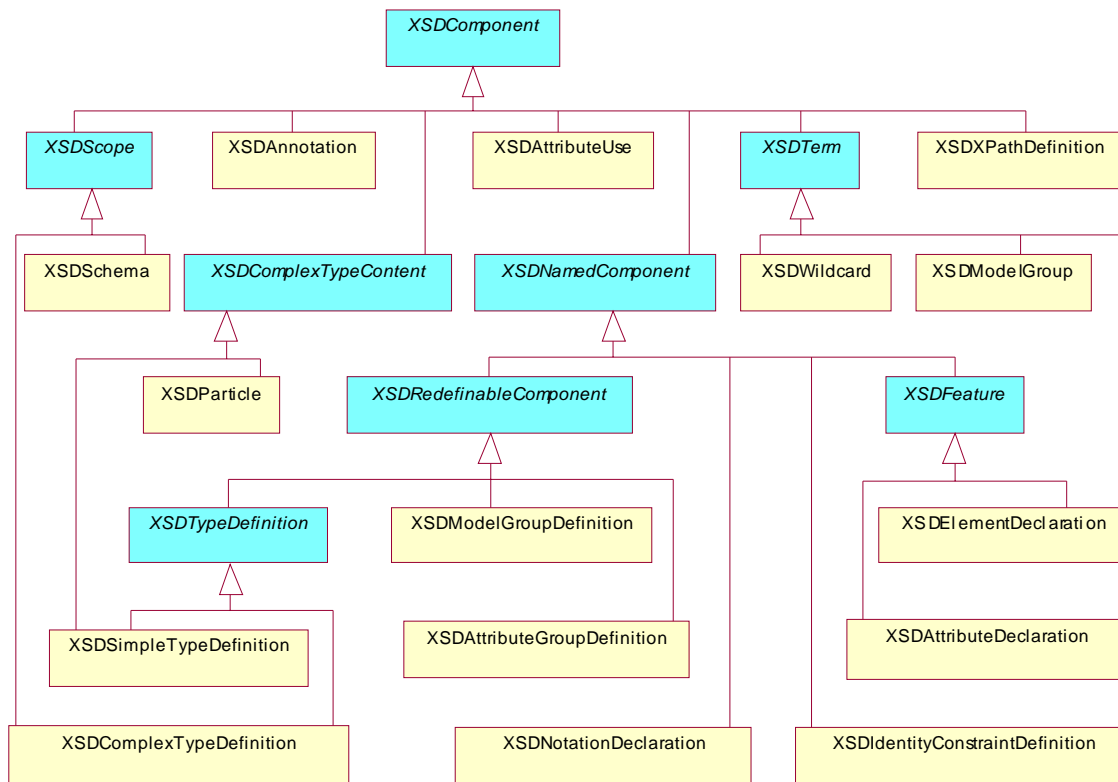
- Figure 8.1 on page 74
- Figure 8.2 on page 75
- Figure 8.3 on page 76
- Figure 8.4 on page 77

The next set of diagrams show aspects of the model that represent the XML Schema concrete syntax:

- Figure 8.5 on page 78
- Figure 8.6 on page 79
- Figure 8.7 on page 80

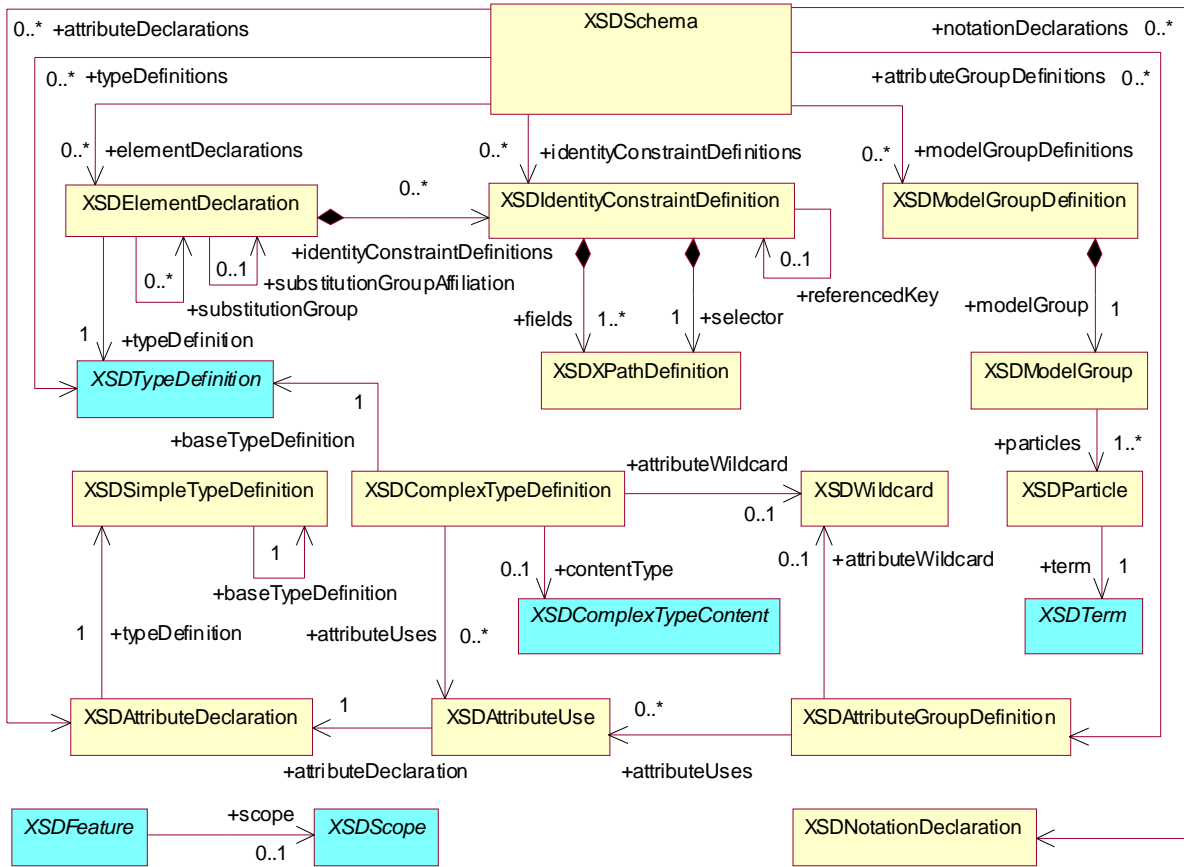
The final diagram (Figure 8.8 on page 81) shows how concrete components resolve into abstract components.

The sub sections following these diagrams describe the model classes in detail. The sub sections are alphabetically ordered by class name.



**Figure 8.1- Component Hierarchy**

The Component Hierarchy diagram introduces classes representing the abstract XML Schema components. Schema components are the building blocks that comprise the abstract data model of the schema. An XML Schema is a set of schema components.



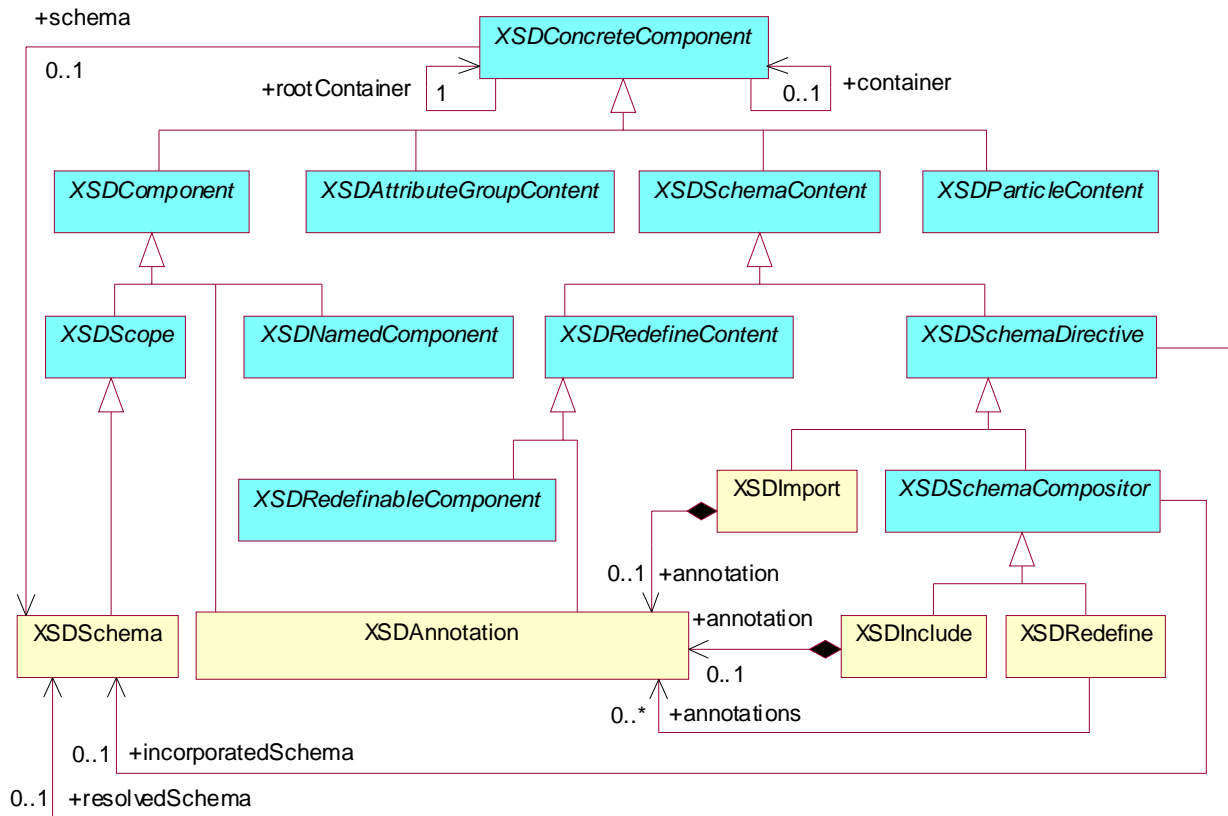
**Figure 8.2- Component Relations**

The Component Relations diagram shows the interrelationships between XML Schema components: which components can contain or reference other components. The XSDAnnotation relations are shown separately in Figure 8.4 on page 77. This is closely aligned with the (non-normative) Schema Components Diagram in XML Schema Part 1: Structures.



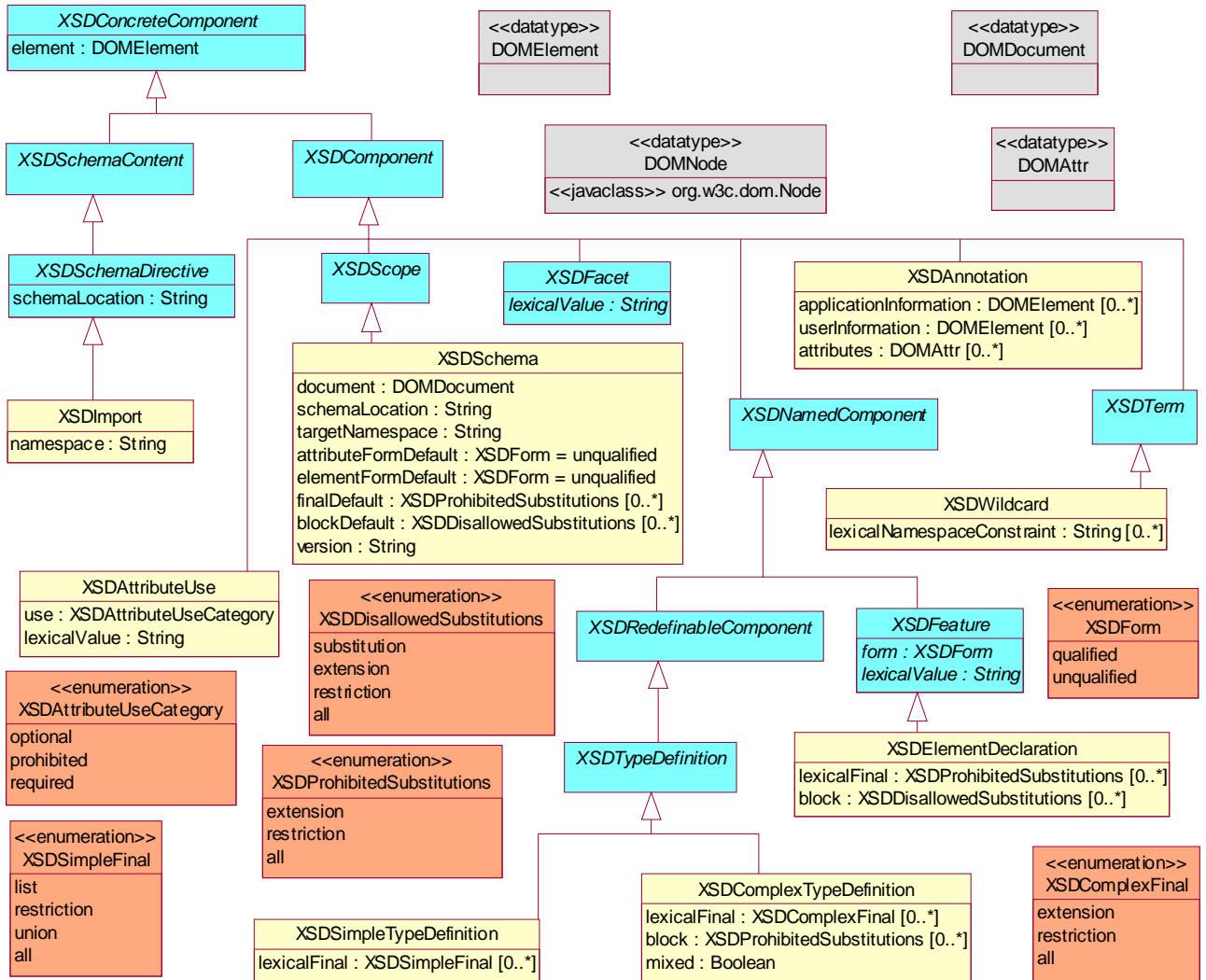






**Figure 8.5- Concrete Components**

The Concrete Components diagram shows the additions and extensions to the abstract XML Schema components for representing the concrete syntax. For example, it introduces classes **XSDImport** (for the import element) and **XSDInclude** (for the include element).



**Figure 8.6- Concrete Properties**

The Concrete Properties diagram shows the additional properties required to represent the concrete syntax.





## 8.2.2 XSDAttributeDeclaration

A representation of the model object 'Attribute Declaration.'

*attributeDeclarationReference*

This concrete property is false when the XSDAttributeDeclaration refers to itself as its resolvedAttributeDeclaration.

An infoset feature will never return an instance for which this is true since this is a concrete attribute that is used to represent an attribute declaration with a ref attribute.

*annotation*

References the XSDAnnotation for this declaration.

*anonymousTypeDefinition*

This concrete reference represents a simple type definition defined within the body of an attribute element.

*typeDefinition*

This represents the type definition infoset property.

*resolvedAttributeDeclaration*

This concrete reference represents the attribute declaration resolved by the ref attribute.

## 8.2.3 XSDAttributeGroupDefinition

A representation of the model object 'Attribute Group Definition.'

*attributeGroupDefinitionReference*

This concrete property is false when the XSDAttributeGroupDefinition refers to itself as its resolvedAttributeGroupDefinition.

*annotation*

This represents the annotation infoset property.

*contents*

This concrete reference represents the contents defined within the body of an attributeGroup element.

*attributeUses*

This represents the attribute uses infoset property. It is computed from the contents.

*attributeWildcardContent*

This concrete reference represents the attribute wildcard defined within the body of an attributeGroup element.

*attributeWildcard*

This represents the attribute wildcard infoset property. It is computed from the attribute wildcard content.

*resolvedAttributeGroupDefinition*

This concrete reference represents the attribute group definition resolved by the ref attribute.

*syntheticWildcard*

This contains the attribute wildcard infoSet property, if the rules require a synthesized component.

#### **8.2.4 XSDAttributeUse**

A representation of the model object ‘Attribute Use.’

*required*

This represents the required infoSet property.

*value*

This represents the value of the value constraint infoSet property. It is computed from the lexical value.

*constraint*

This represents the constraint of the value constraint infoSet property.

*use*

This concrete attribute represents the value of the use attribute.

*lexicalValue*

This concrete attribute represents the value of the default or fixed attribute.

*attributeDeclaration*

This represents the attribute infoSet property. It is computed from the content.

*content*

This concrete reference represents the underlying concrete attribute element.

#### **8.2.5 XSDComplexTypeContent**

A representation of the model object ‘Complex Type Content.’ It is the contentType of XSDComplexTypeDefinitions.

#### **8.2.6 XSDComplexTypeDefinition**

A representation of the model object ‘Complex Type Definition.’

*derivationMethod*

This represents the derivation method infoSet property.

*final*

This represents the final infoSet property. It is computed from the lexical final.

*abstract*

This represents the abstract infoSet property.

*contentTypeCategory*

This represents the category of the content type infoSet property. It is computed from the type of the content and from the setting of mixed.

*prohibitedSubstitutions*

This represents the prohibited substitutions infoSet property. It is computed from the block.

*lexicalFinal*

This concrete attribute represents the value of the final attribute.

*block*

This concrete attribute represents the value of the block attribute.

*mixed*

This concrete attribute represents the value of the mixed attribute.

*contentAnnotation*

This concrete reference represents the annotation content of a complexContent element or a simpleContent element.

*baseTypeDefinition*

This represents the base type definition infoSet property.

*content*

This concrete reference represents the simple type content or particle content of a complexType element. It will be null, an XSDSimpleTypeDefinition, or an XSDParticle.

*contentType*

This represents the value of the content type infoSet property. It is computed from the content. It will be null, an XSDSimpleTypeDefinition, or an XSDParticle.

*attributeUses*

This represents the attribute uses infoSet property. It is computed from the attribute contents.

*attributeContents*

This concrete reference represents the attribute contents defined within the body of a complexType element.

*attributeWildcard*

This represents the attribute wildcard infoSet property. It is computed from the attribute wildcard content.

*attributeWildcardContent*

This concrete reference represents the attribute wildcard defined within the body of a complexType element.



*rootTypeDefinition*

This walks the base type definitions until it hits the one that has the ur-type definition as its base type definition.

*syntheticParticle*

This represents the value of the content type infoSet property, if the rules require a synthesized particle.

*syntheticWildcard*

This represents the attribute wildcard infoSet property, if the rules require a synthesized wildcard.

## **8.2.7 XSDComponent**

A representation of the model object ‘Component.’ It is the root of the infoSet hierarchy.

## **8.2.8 XSDFeature**

A representation of the model object ‘Feature.’ It is used to represent aspects common to ‘Element Declarations’ and ‘Attribute Declaration.’

*value*

This represents the value of the attribute value constraint or element value constraint infoSet property. It is computed from the lexical value.

*constraint*

This represents the constraint of the attribute value constraint or element value constraint infoSet property.

*form*

This concrete attribute represents the value of the attribute form attribute or the element form attribute. It, along with the attribute form default and element form default of the schema, affects the target namespace of locally scoped features.

*lexicalValue*

This concrete attribute represents the value of the attribute fixed or default attribute or the element fixed or default attribute.

*global*

This indicates whether the feature is globally scoped. Its value is false if the feature is declared within a complex type definition, an attribute group definition, or a model group definition.

*featureReference*

This is the same result as either the ‘Element Reference’ attribute or the ‘Attribute Reference’ attribute.

*scope*

This represents the attribute scope or element scope infoSet property.

*resolvedFeature*

This is the same result as either the ‘Resolved Element Declaration’ reference or the ‘Resolved Attribute Declaration’ reference.

*type*

This is the same result as either the element ‘Type Definition’ reference or the attribute ‘Type Definition’ reference.

### **8.2.9 XSDIdentityConstraintDefinition**

A representation of the model object ‘Identity Constraint Definition.’

*identityConstraintCategory*

This represents the identity constraint category infoSet property.

*annotation*

This represents the annotation infoSet property.

*referencedKey*

This represents the referenced key infoSet property.

*selector*

This represents the selector infoSet property.

*fields*

This represents the fields infoSet property. The fields are of type XSDXPathDefinition.

### **8.2.10 XSDModelGroup**

A representation of the model object ‘Model Group.’

*compositor*

This represents the compositor infoSet property.

*annotation*

This represents the annotation infoSet property.

*contents*

This concrete reference represents the particle contents defined within the body of a sequence, choice, or all element.

*particles*

This represents the particles infoSet property.

### **8.2.11 XSDNamedComponent**

A representation of the model object ‘Named Component.’ It is used to represent aspects common to attribute declarations, attribute group definitions, complex type definitions, element declarations, identity constraint definitions, model groups definitions, notation declarations, and simple type definitions.

*name*

This represents the value of the attribute declaration name, attribute group definition name, complex type definition name, element declaration name, identity constraint definition name, model group definition name, notation declaration name, or simple type definition name (\*) infoSet property.

*targetNamespace*

This represents the value of the attribute declaration target namespace, attribute group definition target namespace, complex type definition target namespace, element declaration target namespace, identity constraint definition target namespace, model group definition target namespace, notation declaration target namespace, or simple type definition target namespace (\*) infoSet property. It is computed from the target namespace of the schema and should typically not be set directly; in the case of locally scoped features, the value is also affected by the form.

*aliasName*

This is a constructed name for an anonymous component. In order to make it relatively meaningful, it can be constructed by using the name of the containing component and an indication of the relation to that component. For example, “E\_.\_type” would be the alias name of the anonymous type definition of the element “E” and “LT\_.\_item” would be the alias name of the anonymous item type definition of the list type definition “LT.”

*uRI*

This is equivalent to the string

<target namespace>#<name>

where a null target namespace is taken to mean an empty string.

*aliasURI*

This is equivalent to the string

<target namespace>#<alias name>

where a null target namespace is taken to mean an empty string.

*qName*

This concrete attribute is this named component's ‘QName.’

## 8.2.12 XSDSchema

A representation of the model object ‘Schema.’

*document*

This is the optional DOM document of this schema (i.e., the owner of the element).

*schemaLocation*

This concrete attribute represents the URI of the resource that contains this schema. It is used to complete any relative schemaLocation URI in an import, include, or redefine.

*targetNamespace*

This concrete attribute represents the value of the targetNamespace attribute.

*attributeFormDefault*

This concrete attribute represents the value of the attributeFormDefault attribute.

*elementFormDefault*

This concrete attribute represents the value of the elementFormDefault attribute.

*finalDefault*

This concrete attribute represents the value of the finalDefault attribute.

*blockDefault*

This concrete attribute represents the value of the blockDefault attribute.

*version*

This concrete attribute represents the value of the version attribute.

*contents*

This concrete reference represents the contents defined within the body of a schema element.

*elementDeclarations*

This represents the element declarations infoSet property. It is computed from the contents.

*attributeDeclarations*

This represents the attribute declarations infoSet property. It is computed from the contents.

*attributeGroupDefinitions*

This represents the attribute group definitions infoSet property. It is computed from the contents.

*typeDefinitions*

This represents the type definitions infoSet property. It is computed from the contents.

*modelGroupDefinitions*

This represents the model group definitions infoSet property. It is computed from the contents.

*identityConstraintDefinitions*

This represents the model group definitions infoSet property. It is computed from the contents.

*notationDeclarations*

This represents the notation declarations infoSet property. It is computed from the contents.

*annotations*

This represents the annotations infoSet property. It is computed from the contents.

*referencingDirectives*

This represents the directives that have this schema as their ‘Resolved Schema’ reference or ‘Incorporated Schema’ reference.

*rootVersion*

This walks the original versions until it hits one that has no original version.

*originalVersion*

This represents the schema from which an incorporated version originates. The root version has itself as its original version.

*incorporatedVersions*

This represents those versions of this schema that have been included into a schema with a different namespace or have been otherwise redefined.

*schemaForSchema*

This represents the ‘schema for schemas.’ It is computed from the schema for schema namespace.

### **8.2.13 XSDScope**

A representation of the model object ‘Scope.’ This is used to represent the types the scope property of XSDFeature (i.e., ‘Schema’ and ‘Complex Type Definition.’)

### **8.2.14 XSDSimpleTypeDefinition**

A representation of the model object ‘Simple Type Definition.’ For the properties with names of the form *effectiveXxxFacet*, *effective* means that the value of the property is computed based on the direct facets of this type, or, if the facet is not present, is computed recursively from the base type.

*variety*

This represents the variety infoSet property. It is computed based on the presence or absence of an item type or of member types.

*final*

This represents the final infoSet property. It is computed from the lexical final.

*lexicalFinal*

This concrete attribute list represents the value of the final attribute.

*validFacets*

This computed attribute list represents the facet name of each type of facet that is valid for this simple type definition.

*contents*

This concrete reference list represents the anonymous simple type definition content of a restriction, list, or union element.

### *facetContents*

This concrete reference list represents the facet contents of a restriction. There are properties with names of the form XxxFacet that provide direct access to the individual facets.

### *facets*

This represents the facets infoSet property. It is computed from the facet contents.

### *memberTypeDefinitions*

This represents the member type definitions infoSet property. When constructing a union type, each anonymous member type should be added to both this list and to the contents list. The variety is determined automatically by the presence of member type definitions.

### *fundamentalFacets*

This represents the fundamental facets infoSet property. It is a computed property.

### *baseTypeDefinition*

This represents the base type definition infoSet property.

### *primitiveTypeDefinition*

This represents the primitive type definition infoSet property.

### *itemTypeDefinition*

This represents the item type definition infoSet property. When constructing a list type, an anonymous item type should be both set using this method and added to the contents list. The variety is determined automatically by the presence of an item type definition.

### *rootTypeDefinition*

This walks the base type definitions until it hits that one that has the ur-type definition as its base type definition.

### *minFacet*

This represents the XSDMinFacet of the facet contents.

### *maxFacet*

This represents the XSDMaxFacet of the facet contents.

### *maxInclusiveFacet*

This represents the XSDMaxInclusiveFacet of the facet contents.

### *minInclusiveFacet*

This represents the XSDMinInclusiveFacet of the facet contents.

### *minExclusiveFacet*

This represents the XSDMinExclusiveFacet of the facet contents.

*maxExclusiveFacet*

This represents the XSDMaxExclusiveFacet of the facet contents.

*lengthFacet*

This represents the XSDLengthFacet of the facet contents.

*whiteSpaceFacet*

This represents the XSDWhiteSpaceFacet of the facet contents.

*enumerationFacets*

This represents the XSDEnumerationFacet of the facet contents.

*patternFacets*

This represents the XSDPatternFacet of the facet contents.

*cardinalityFacet*

This represents the XSDCardinalityFacet of the fundamental facets.

*numericFacet*

This represents the XSDNumericFacet of the fundamental facets.

*maxLengthFacet*

This represents the XSDMaxLengthFacet of the facet contents.

*minLengthFacet*

This represents the XSDMinLengthFacet of the facet contents.

*totalDigitsFacet*

This represents the XSDTotalDigitsFacet of the facet contents.

*orderedFacet*

This represents the XSDOrderedFacet of the fundamental facets.

*boundedFacet*

This represents the XSDBoundedFacet of the fundamental facets.

*effectiveMaxFacet*

This represents the XSDMaxFacet of the facets.

*effectiveWhiteSpaceFacet*

This represents the XSDWhiteSpaceFacet of the facets.

*effectiveMaxLengthFacet*

This represents the XSDMaxLengthFacet of the facets.

*effectiveFractionDigitFacet*

This represents the XSDFractionDigitsFacet of the facets.

*effectivePatternFacet*

This represents the XSDPatternFacet of the facets.

*effectiveEnumerationFacet*

This represents the XSDEnumerationFacet of the facets.

*effectiveTotalDigitsFacet*

This represents the XSDTotalDigitsFacet of the facets.

*effectiveMinLengthFacet*

This represents the XSDMinLengthFacet of the facets.

*effectiveLengthFacet*

This represents the XSDLengthFacet of the facets.

*effectiveMinFacet*

This represents the XSDMinLengthFacet of the facets.

*syntheticFacets*

This represents the facets infoSet property, if the rules require a synthesized facet.

### **8.2.15 XSDTerm**

A representation of the model object ‘Term.’ It is used as the type for the XSDParticle term property.

### **8.2.16 XSDTypeDefinition**

A representation of the model object ‘Type Definition.’ It is used to represent aspects common to ‘Simple Type Definitions’ and ‘Complex Type Definitions.’

*annotation*

This concrete reference represents the direct annotation content of a complexType element or a simpleType element.

*derivationAnnotation*

This concrete reference represents the direct annotation content of a complex content extension, complex content restriction, simple content extension, simple content restriction, simple type restriction, simple type list, or simple type union element.

*annotations*

This represents the complex type definition annotation or simple type definition annotation infoSet property. It is computed from the annotation, content annotation, derivationAnnotation.



*rootType*

This walks the base types until it hits that one that has the ur-type definition as its base type.

*baseType*

This represents the same result as either the simple 'Base Type Definition' reference or the complex 'Base Type Definition' reference.

*simpleType*

This represents either the 'Simple Type Definition' itself or the complex 'Content Type' reference, if it is simple.

*complexType*

This represents the complex 'Content Type' reference, if it is complex (i.e., if it is a 'Particle').

### **8.2.17 XSDWildcard**

A representation of the model object 'Wildcards.'

*namespaceConstraintCategory*

This represents the category of the namespace constraint infoset property.

*namespaceConstraint*

This represents the value of the namespace constraint infoset property. It is computed from the lexical namespace constraint and should typically not be modified directly.

*processContents*

This represents the process contents infoset property.

*lexicalNamespaceConstraint*

This concrete attribute represents the value of the any namespace or anyAttribute namespace attribute.

*annotation*

This concrete reference represents the annotation content of an any or anyAttribute element.

*annotations*

This represents the annotation infoset property. It is computed from the annotation.

### **8.2.18 XSDXPathDefinition**

A representation of the model object 'XPath Definition.' It represents a field or selector of an Identity-constraint Definition. It defines a restricted XPath. It is used to represent the types of object returned by the 'Fields' reference list and the 'Selector' reference.

*variety*

This attribute represents whether this is a field or a selector.

value

This concrete attribute represents the value of the selector xpath or field xpath attribute.

annotation

This concrete reference represents the annotation contents defined within the body of a field or selector element.

### 8.3 XML Schema Datatypes

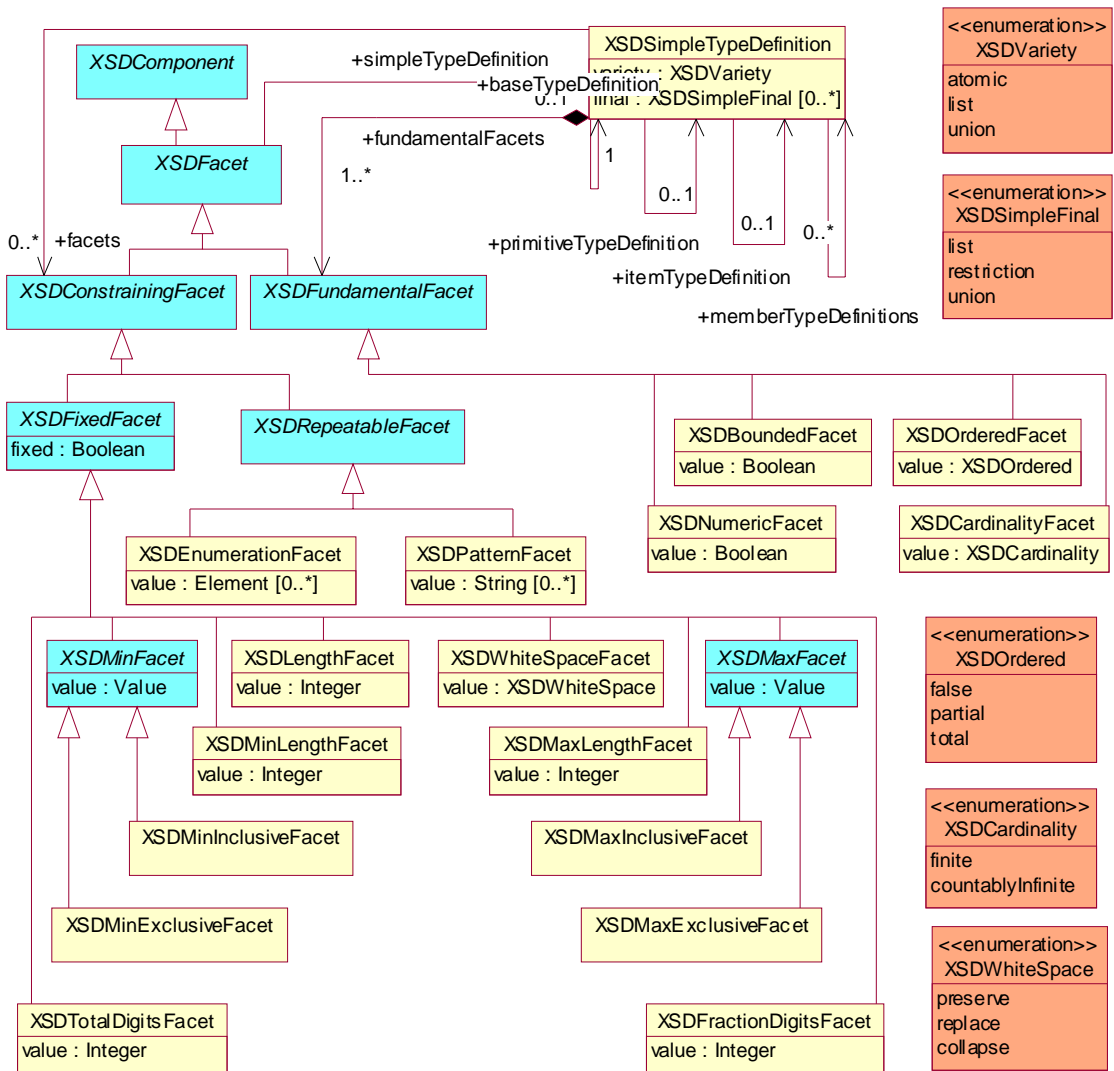


Figure 8.9- Component Hierarchy, Relations, and Properties (Part 2: Datatypes)

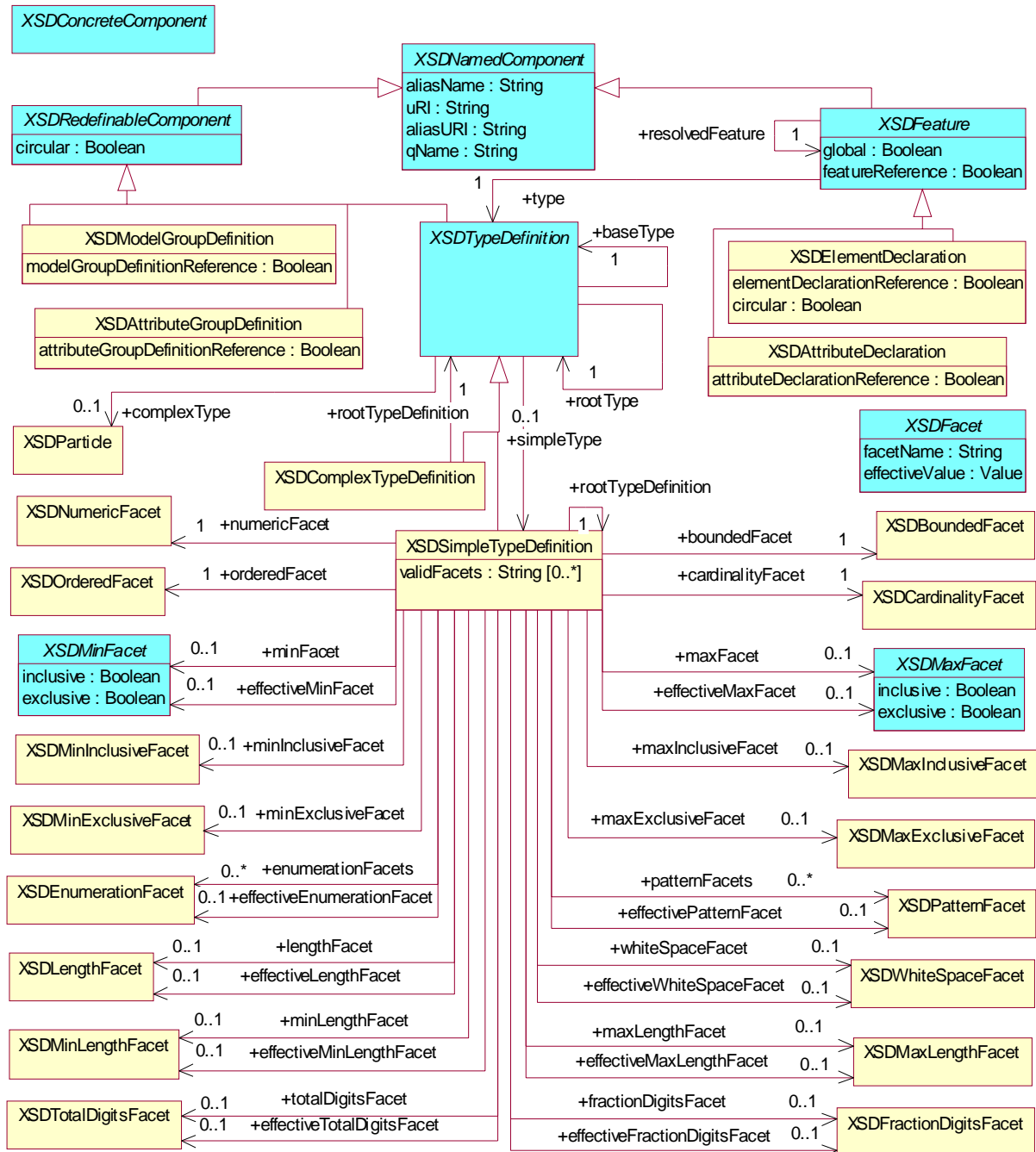
The Component Hierarchy, Relations, and Properties (Part 2: Datatypes) diagram represents the abstract XML Schema components as defined in XML Schema Part 2: Datatypes. Each datatype has a value space, which is the set of values for that datatype. A facet is a single defining aspect of a value space. Generally speaking, each facet characterizes a value space along independent axes or dimensions. The facets of a datatype serve to distinguish those aspects of one datatype that differ from other datatypes.

Facets are of two types: fundamental facets that define the datatype, and constraining facets constrain the permitted values of a datatype. For example, the XML Schema string datatype has the following constraining facets:

- length
- minLength
- maxLength
- pattern
- enumeration
- whiteSpace

In contrast, the boolean datatype has these constraining facets:

- pattern
- whiteSpace



**Figure 8.10- Supplemental**

The Supplemental diagram primarily models the relationships between type definitions and facets.

### **8.3.1 XSDBoundedFacet**

A representation of the model object 'Bounded Facet.'

*value*

This represents the value info:property. It is a computed property.

### **8.3.2 XSDCardinalityFacet**

A representation of the model object 'Cardinality Facet.'

*value*

This represents the value info:property. It is a computed property.

### **8.3.3 XSDConstrainingFacet**

A representation of the model object 'Constraining Facet.'

### **8.3.4 XSDEnumerationFacet**

A representation of the model object 'Enumeration Facet.'

*value*

This represents the value info:property. It is computed from the 'Lexical Value' attribute.

### **8.3.5 XSDFixedFacet**

A representation of the model object 'Fixed Facet.'

*fixed*

This represents the fractionDigitsFacet fixed, lengthFacet fixed, maxExclusiveFacet fixed, maxInclusiveFacet fixed, maxLengthFacet fixed, minExclusiveFacet fixed, minInclusiveFacet fixed, minLengthFacet fixed, totalDigitsFacet fixed, whiteSpaceFacet fixed info:property.

### **8.3.6 XSDFundamentalFacet**

A representation of the model object 'Fundamental Facet.'

### **8.3.7 XSDFacet**

A representation of the model object 'Facet.'

*lexicalValue*

This concrete attribute represents the value of the value attribute of the facet element.

*facetName*

This concrete attribute represents the name of this type of facet.

*effectiveValue*

This represents a generic version of the value info set property of this facet.

*annotation*

This represents the annotation info set property; each type of facet has an annotation.

*simpleTypeDefinition*

This represents the containing simple type definition of the facet.

### **8.3.8 XSDFractionDigitsFacet**

A representation of the model object 'Fraction Digits Facet.'

*value*

This represents the value info set property. It is computed from the 'Lexical Value' attribute.

### **8.3.9 XSDLengthFacet**

A representation of the model object 'Length Facet.'

*value*

This represents the value info set property. It is computed from the 'Lexical Value' attribute.

### **8.3.10 XSDMaxExclusiveFacet**

A representation of the model object 'Max Exclusive Facet.'

### **8.3.11 XSDMaxFacet**

A representation of the model object 'Max Facet.' It represents aspects common to 'Max Exclusive Facet' and 'Max Inclusive Facet.'

*value*

This represents the value info set property. It is computed from the 'Lexical Value' attribute.

*inclusive*

The value is true if this is an XSDMaxInclusiveFacet.

*exclusive*

The value is true if this is an XSDMaxExclusiveFacet.

### **8.3.12 XSDMaxInclusiveFacet**

A representation of the model object 'Max Inclusive Facet.'

### **8.3.13 XSDMaxLengthFacet**

A representation of the model object 'Max Length Facet.'

*value*

This represents the value info set property. It is computed from the 'Lexical Value' attribute.

### **8.3.14 XSDMinFacet**

A representation of the model object 'Min Facet.' It represents aspects common to 'Min Exclusive Facet' and 'Min Inclusive Facet.'

*value*

This represents the value info set property. It is computed from the 'Lexical Value' attribute.

*inclusive*

The value is true if this is an XSDMinInclusiveFacet.

*exclusive*

The value is true if this is an XSDMinExclusiveFacet.

### **8.3.15 XSDMinExclusiveFacet**

A representation of the model object 'Min Exclusive Facet.'

### **8.3.16 XSDMinInclusiveFacet**

A representation of the model object 'Min Inclusive Facet'.

### **8.3.17 XSDMinLengthFacet**

A representation of the model object 'Min Length Facet.'

*value*

This represents the value info set property. It is computed from the 'Lexical Value' attribute.

### **8.3.18 XSDNumericFacet**

A representation of the model object 'Numeric Facet.'

*value*

This represents the value info set property. It is a computed property.

### **8.3.19 XSDOrderedFacet**

A representation of the model object 'Ordered Facet.'

*value*

This represents the value info set property. It is a computed property.

### 8.3.20 XSDPatternFacet

A representation of the model object ‘Pattern Facet.’

*value*

This represents the value infoSet property. It is computed from the ‘Lexical Value’ attribute. *value* is a multi-valued property, in which each value is a String representing a pattern. The overall effect of the patterns is the logical intersection.

### 8.3.21 XSDRepeatableFacet

A representation of the model object ‘Repeatable Facet.’

Both pattern and enumeration facets may be repeated in the concrete syntax and yet they are merged into a single component in the infoSet model. As a result, instances of these two facets are synthesized by the `effectivePatternFacet` and `effectiveEnumerationFacet` properties of `XSDSimpleTypeDefinition`.

*annotations*

This represents the enumeration annotation, or pattern annotation infoSet property. It is computed from the concrete annotation content.

### 8.3.22 XSDTotalDigitsFacet

A representation of the model object ‘Total Digits Facet.’

*value*

This represents the value infoSet property. It is computed from the ‘Lexical Value’ attribute.

### 8.3.23 XSDWhiteSpaceFacet

A representation of the model object ‘White Space Facet.’

*value*

This represents the value infoSet property. It is computed from the ‘Lexical Value’ attribute.

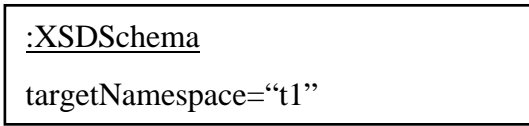
## 8.4 Example

This section shows how a simple XML Schema is represented as an instance of the XML InfoSet model. The schema in this example is:

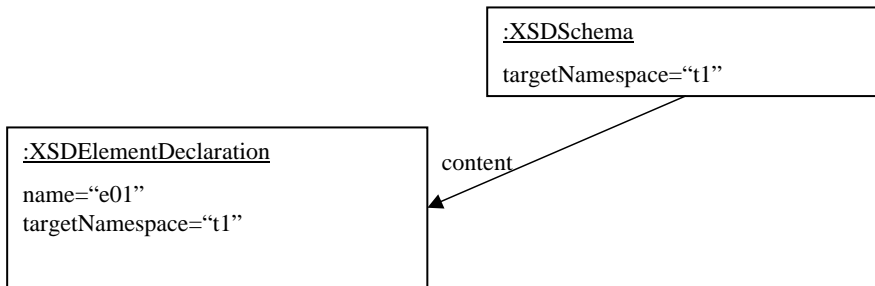
```
<xs:schema targetNamespace=t1 xmlns:xs=http://www.w3.org/2001/XMLSchema>
  <xs:element name="e01" type="ct01"/>
  <xs:complexType name="ct01">
    <xs:choice>
      <xs:element name="inline" type="xs:string" minOccurs="2" maxOccurs="3"/>
      <xs:any namespace="##other"/>
    </xs:choice>
  </xs:complexType>
</xs:schema>
```



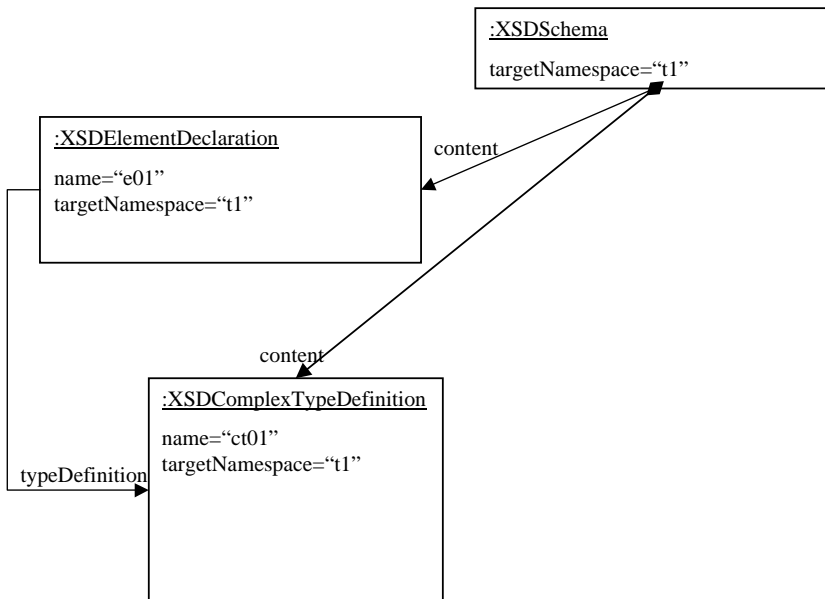
The information in the **xs:schema** tag is represented by an :XSDSchema.



The information in the **xs:element** tag adds in an XDSElementDeclaration (excluding for the moment the reference to its type).

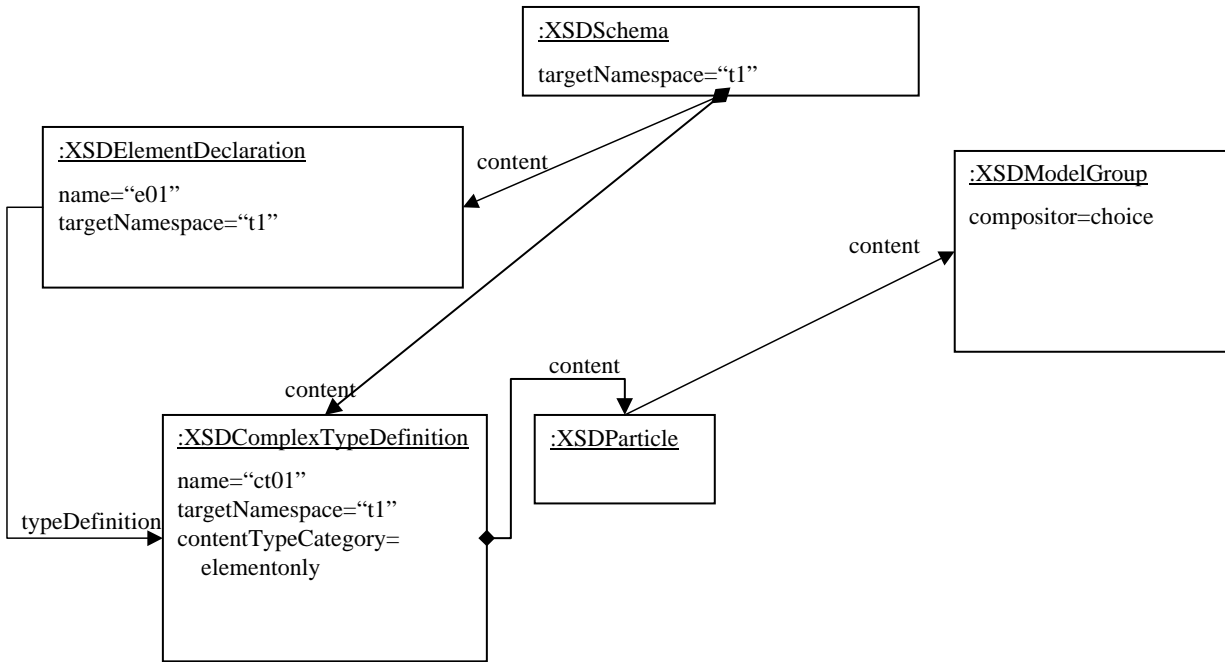


The information in the **xs:complexType** tag adds an :XSDComplexTypeDefinition. Since this is the type for element e01, the :XDSElementDeclaration references the :XSDComplexTypeDefinition through the typeDefinition property.

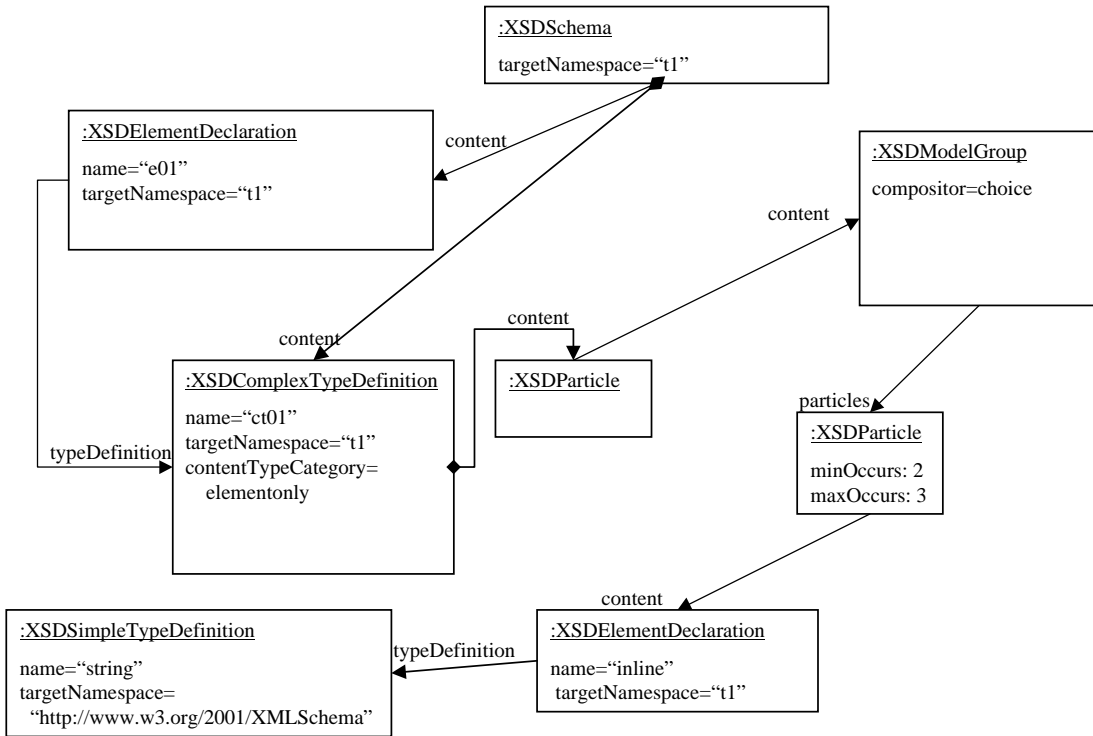


Complex type ct01 contains an **xs:choice** tag. This means that the content type of the complex type definition is a pair consisting of

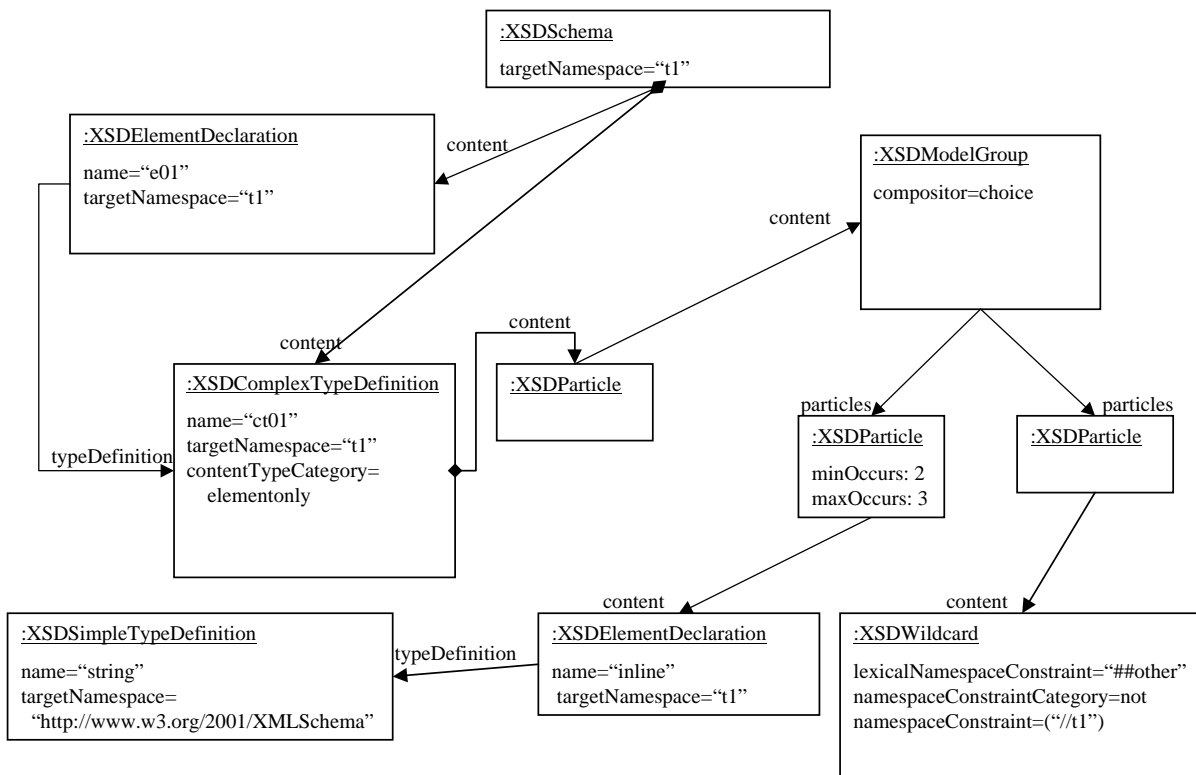
- *elementonly*. This is represented by the contentTypeCategory property in the XSDComplexTypeDefinition.
- The particle corresponding to the <choice>. Particles corresponding to a <choice> have terms that are model groups. This particle is represented in the instance diagram by an XSDParticle that references an XSDModelGroup whose compositor has the value “choice.”



The first element within the choice is an **xs:element** tag named "inline." This means that the model group has a particle whose term is an element declaration. The **minOccurs** and **maxOccurs** attributes in the **xs:element** tag are represented by the **XSDParticle**'s `minOccurs` and `maxOccurs` properties. The **type** attribute in the tag is represented by an **XSDSimpleTypeDefinition** for the XML Schema string type. This is shown in the instance diagram below.



The second element within the choice is an **xs:any** tag. This means that the model group has another particle, whose term is a wildcard. This is shown in the instance diagram by an XSDInstance and an XSDWildcard, completing the representation of the schema:



## Annex A - References

- [XML]** XML, a technical recommendation standard of the W3C.  
<http://www.w3.org/TR/REC-xml>
- [XMLSchema]** XML Schemas, a proposed recommendation of the W3C.  
Primer: <http://www.w3.org/TR/xmlschema-0/>,  
Structured types: <http://www.w3.org/TR/xmlschema-1/>  
Data types: <http://www.w3.org/TR/xmlschema-2/>
- [NAMESPACE]** Namespaces, a technical recommendation of the W3C.  
<http://www.w3.org/TR/REC-xml-names>
- [XLINK]** XLinks, a working draft of the W3C. <http://www.w3.org/TR/WD-xlink> and  
<http://www.w3.org/TR/NOTE-xlink-principles>
- [XPath]** XPointer, technical recommendation of the W3C.  
<http://www.w3.org/TR/xpath>
- [UML]** UML 2.0, an in progress standard of the OMG. More specifically, this refers to the UML 2.0 Infrastructure submission. See [http://www.omg.org/techprocess/meetings/schedule/UML\\_2.0\\_Infrastructure\\_RFP.html](http://www.omg.org/techprocess/meetings/schedule/UML_2.0_Infrastructure_RFP.html).
- [MOF]** MOF 2.0, an in progress standard of the OMG. More specifically, this refers to the MOF 2.0 Core submission. See [http://www.omg.org/techprocess/meetings/schedule/MOF\\_2.0\\_Core\\_RFP.html](http://www.omg.org/techprocess/meetings/schedule/MOF_2.0_Core_RFP.html).
- [XMI]** XMI 2.0, an adopted standard of the OMG.  
<http://www.omg.org>

The following is the Open Group DCE standard on UUIDs.

- [UUID]** CAE Specification  
DCE 1.1: Remote Procedure Call  
Document Number: C706  
<http://www.opengroup.org/onlinepubs/9629399/toc.htm>  
<http://www.opengroup.org/onlinepubs/9629399/apdxa.htm> (Definition/creation of UUIDs)



## INDEX

### A

Abstractions package 62  
Add class 12  
Attributes 13

### C

Class representation 17  
classes 8  
CMOF Package 64  
compliance 1, 2  
Composite representation 19  
Creating tool 40

### D

Datatype representation 20  
DCE 14  
Delete class 12  
Derived information 21  
Difference class 12  
Differences 38  
Documentation class 11  
DTD to MOF 67

### E

EBNF notation 43  
Element identification attributes 13  
EMOF Package 63  
Extended Backus Naur Form (EBNF) 58  
Extension class 11  
extension elements 7

### F

fixed declarations 50

### G

GIS Model 32

### I

Importing tool 40  
Inheritance representation 21

### L

Language Formalism 5, 43, 57, 67, 73, 105  
Linking 22, 23  
Linking attributes 14  
Links 22

### M

model fragments 21  
Modifying tool 40  
Multiplicities 17

### N

Namespace 16

### O

object structure 59  
overall document structure 58

### P

production rules 57, 58  
Property representation 18

### R

Reference representation 19  
reverse engineering compliance 2

### S

schema production (tailoring) 25  
serialization patterns 57  
software compliance 1

### T

tag settings 10  
tag value constraints 27  
Tag-Value 18  
timestamp 10  
tool (creating) 40  
tool (importing) 40  
tool (modifying) 41  
Tool ID policies 40  
tools 39  
Transmitting Incomplete Metadata 21  
Transmitting Metadata Differences 30  
Type attribute 15

### U

UUID 14

### V

Value 18  
verified 10  
Version attribute 15

### X

XLink 22  
XLinks 23  
xmi  
  extenderID 11  
  id 14  
  idref 15  
  label 14  
  position 12  
  uuid 14  
  version 10  
XMI element 10  
XMI namespace 8  
XMI schema requirements 6  
XMI tag values 26  
XMI Types 16  
XMI.element.att 13  
XMI.extension 11  
XMI.link.att 14  
XMIDataType 18  
XML declarations 6  
XML Namespace specification 5  
XML schema 5  
XML Schema Datatypes 94  
XML Schema Infoset model 73  
XML schema model compliance 2  
XML Schema Structures 73

XML Schema to MOF 69  
XML to MOF 68  
XML validation 6  
XSDAnnotation 81  
XSDAttributeDeclaration 82  
XSDAttributeGroupDefinition 82  
XSDAttributeUse 83  
XSDBoundedFacet 97  
XSDCardinalityFacet 97  
XSDComplexTypeContent 83  
XSDComplexTypeDefinition 83  
XSDComponent 85  
XSDConstrainingFacet 97  
XSDEnumerationFacet 97  
XSDFacet 97  
XSDFeature 85  
XSDFixedFacet 97  
XSDFractionDigitsFacet 98  
XSDFundamentalFacet 97  
XSDLengthFacet 98  
XSDMaxExclusiveFacet 98  
XSDMaxFacet 98  
XSDMaxInclusiveFacet 98  
XSDMaxLengthFacet 98  
XSDMinExclusiveFacet 99  
XSDMinFacet 99  
XSDMinInclusiveFacet 99  
XSDMinLengthFacet 99  
XSDModelGroup 86  
XSDNamedComponent 86  
XSDNumericFacet 99  
XSDOrderedFacet 99  
XSDPatternFacet 100  
XSDRepeatableFacet 100  
XSDSchema 87  
XSDScope 89  
XSDSimpleTypeDefinition 89  
XSDTerm 92  
XSDTotalDigitsFacet 100  
XSDTypeDefinition 92  
XSDWhiteSpaceFacet 100  
XSDWildcard 93  
XSDXPathDefinition 93